

# UPS Cabinet

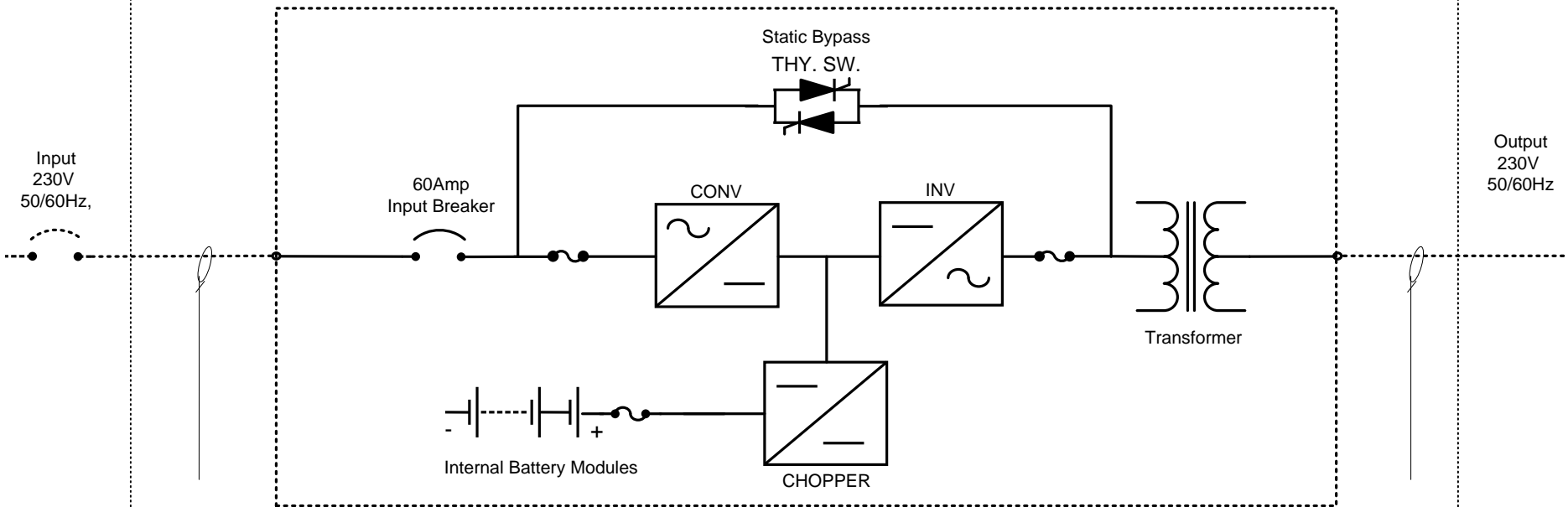

## Hardwire Configuration

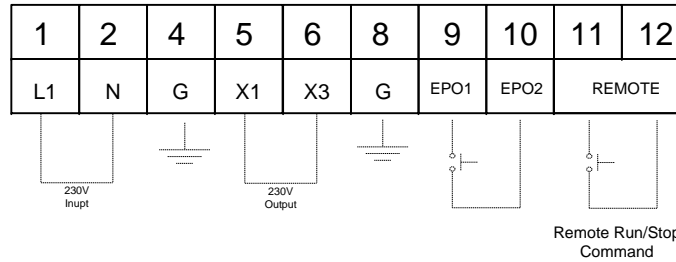

### NOTES

DRAWN BY	DATE
JE	11/17/05
APPROVED	DATE
GM	11/17/05

**TOSHIBA**  
INTERNATIONAL CORPORATION  
Houston Texas, USA

THIS MATERIAL IS THE EXCLUSIVE PROPERTY OF TOSHIBA INTERNATIONAL CORPORATION AND SHALL NOT BE REPRODUCED, USED, OR DISCLOSED TO OTHERS UNLESS PRIOR WRITTEN AUTHORIZATION IS OBTAINED.

TITLE	
1600 EP Series 8 kVA Model 230V Input 230V Output	
DRAWING NO.	REV.
UE3E1E080-5T	1.0