

TOSHIBA CMOS Digital Integrated Circuit Silicon Monolithic

# TC7MBL3245AFK

## Octal Bus Switch

The TC7MBL3245AFK provides eight bits of low-voltage, high-speed bus switching in a standard '245 device pinout. The low ON-resistance of the switch allows connections to be made with minimal propagation delay and while maintaining CMOS low power dissipation.

The device comprises a single 8-bit switch. When output enable ( $\overline{OE}$ ) is low, the switch is on and port A is connected to port B. When  $\overline{OE}$  is high, the switch is open and a high-impedance state exists between the two ports.

All inputs are equipped with protection circuits to guard against static discharge.

### Features

- Operating voltage:  $V_{CC} = 2.0\sim 3.6\text{ V}$
- High speed:  $t_{pd} = 0.31\text{ ns (max) @ } V_{CC} = 3.0\text{ V}$
- Low ON-resistance:  $R_{ON} = 5\ \Omega\text{ (typ.) @ } V_{CC} = 3.0\text{ V}$
- ESD performance: human body model  $> \pm 2000\text{ V}$   
machine model  $> \pm 200\text{ V}$
- Power-down protection for inputs ( $\overline{OE}$  input only)
- Package: VSSOP (US20)
- Pin compatible with the 74xx245 type
- .

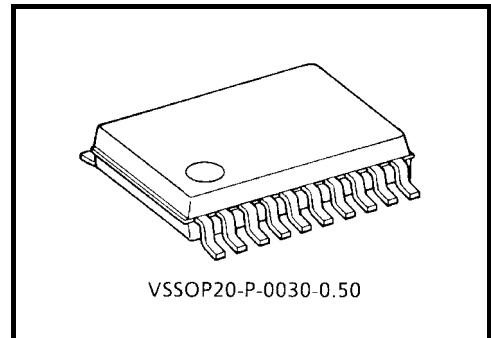

Weight: 0.03 g (typ.)

### Pin Assignment (top view)

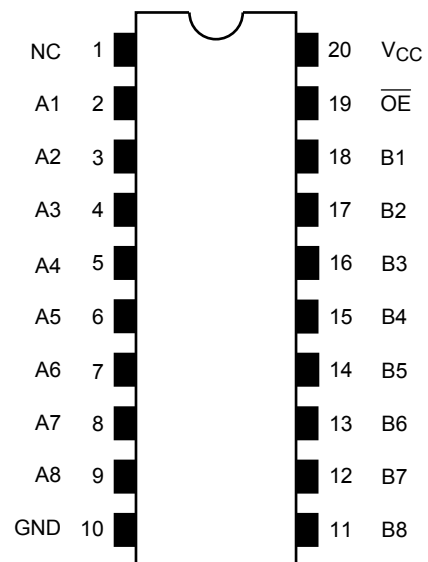

NC-No Internal Connection

## Truth Table

Inputs	Function
$\overline{OE}$	
L	A port = B port
H	Disconnect

## System Diagram

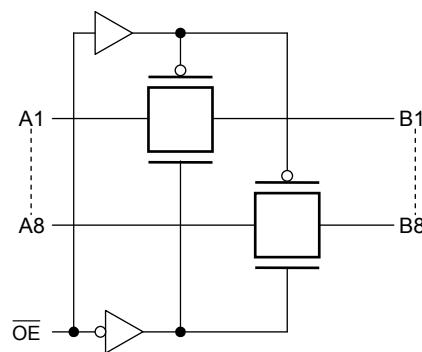

## Absolute Maximum Ratings (Note)

Characteristic	Symbol	Rating	Unit
Power supply range	$V_{CC}$	-0.5~4.6	V
Control pin input voltage	$V_{IN}$	-0.5~4.6	V
Switch terminal I/O voltage	$V_S$	-0.5~ $V_{CC}+0.5$	V
Clump diode current	Control input pin	-50	mA
	Switch terminal	$\pm 50$	
Switch I/O current	$I_S$	128	mA
Power dissipation	$P_D$	180	mW
DC $V_{CC}/GND$ current	$I_{CC}/I_{GND}$	$\pm 100$	mA
Storage temperature	$T_{stg}$	-65~150	$^{\circ}C$

Note : Exceeding any of the absolute maximum ratings, even briefly, may lead to deterioration in IC performance or even destruction.

## Operating Range (Note)

Characteristic	Symbol	Rating	Unit
Power supply voltage	$V_{CC}$	2.0~3.6	V
Control pin input voltage	$V_{IN}$	0~3.6	V
Switch I/O voltage	$V_S$	0~ $V_{CC}$	V
Operating temperature	$T_{opr}$	-40~85	$^{\circ}C$
Input rise and fall time	dt/dv	0~10	ns/V

Note: The operating range must be maintained to ensure the normal operation of the device. Unused inputs must be tied to either  $V_{CC}$  or GND.

## Electrical Characteristics

### DC Characteristics (Ta = -40 to 85°C)

Characteristic	Symbol	Test Condition	V <sub>CC</sub> (V)	Min	Typ.	Max	Unit
High-level control input voltage	V <sub>IH</sub>	—	2.0 to 3.6	0.7 × V <sub>CC</sub>	—	—	V
Low-level control input voltage	V <sub>IL</sub>	—	2.0 to 3.6	—	—	0.3 × V <sub>CC</sub>	
Control input current	I <sub>IN</sub>	V <sub>IN</sub> = 0 to 3.6 V	2.0 to 3.6	—	—	±1.0	μA
Power off leakage current	I <sub>OFF</sub>	$\overline{OE}$ = 0 to 3.6 V	0	—	—	±1.0	μA
Off-stage leakage current (switch off)	I <sub>SZ</sub>	A, B = 0 to V <sub>CC</sub> , $\overline{OE}$ = V <sub>CC</sub>	2.0 to 3.6	—	—	±1.0	μA
Switch ON-resistance (Note 2)	R <sub>ON</sub>	V <sub>IS</sub> = 0 V, I <sub>IS</sub> = 30 mA (Note 1)	3.0	—	2	7	Ω
		V <sub>IS</sub> = 3.0 V, I <sub>IS</sub> = 30 mA (Note 1)	3.0	—	3	9	
		V <sub>IS</sub> = 2.4 V, I <sub>IS</sub> = 15 mA (Note 1)	3.0	—	5	20	
		V <sub>IS</sub> = 0 V, I <sub>IS</sub> = 24 mA (Note 1)	2.3	—	3	10	
		V <sub>IS</sub> = 2.3 V, I <sub>IS</sub> = 24 mA (Note 1)	2.3	—	4	15	
Quiescent supply current	I <sub>CC</sub>	V <sub>IN</sub> = V <sub>CC</sub> or GND, I <sub>OUT</sub> = 0	3.6	—	—	10	μA

Note 1: All typical values are at Ta = 25°C.

Note 2: Measured by voltage drop between A and B pins at indicated current through the switch. ON-resistance is determined by the lower of the voltages on the two pins (A or B).

### AC Characteristics (Ta = -40 to 85°C)

Characteristic	Symbol	Test Condition	V <sub>CC</sub> (V)	Min	Max	Unit
Propagation delay (bus to bus)	t <sub>pLH</sub> t <sub>pHL</sub>	Figure 1, Figure 2 (Note)	3.3 ± 0.3	—	0.31	ns
			2.5 ± 0.2	—	0.52	
Output enable time	t <sub>pZL</sub> t <sub>pZH</sub>	Figure 1, Figure 3	3.3 ± 0.3	—	6.5	ns
			2.5 ± 0.2	—	8	
Output disable time	t <sub>pLZ</sub> t <sub>pHZ</sub>	Figure 1, Figure 3	3.3 ± 0.3	—	6.5	ns
			2.5 ± 0.2	—	8	

Note: This parameter is guaranteed by design but is not tested. The bus switch contributes no propagation delay other than the RC delay of the typical ON-resistance of the switch and the 50 pF load capacitance when driven by an ideal voltage from the source (zero output impedance).

### Capacitance (Ta = 25°C)

Characteristic	Symbol	Test Condition	V <sub>CC</sub> (V)	Typ.	Unit	
Control input capacitance	C <sub>IN</sub>	(Note)	3.0	3	pF	
Switch terminal capacitance	C <sub>I/O</sub>	$\overline{OE}$ = V <sub>CC</sub>	(Note)	3.0	17	pF

Note: This parameter is guaranteed by design.

**AC Test Circuit**

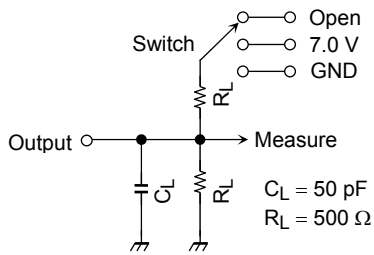

Parameter	Switch
$t_{pLH}$ , $t_{pHL}$	Open
$t_{pLZ}$ , $t_{pZL}$	$2 \times V_{CC}$
$t_{pHZ}$ , $t_{pZH}$	GND

**Figure 1**

**AC Waveforms**

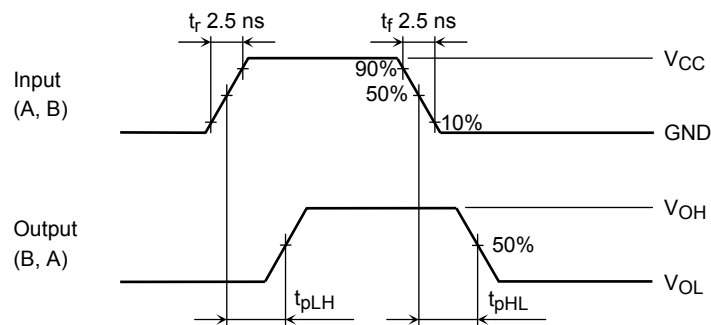

**Figure 2  $t_{pLH}$ ,  $t_{pHL}$**

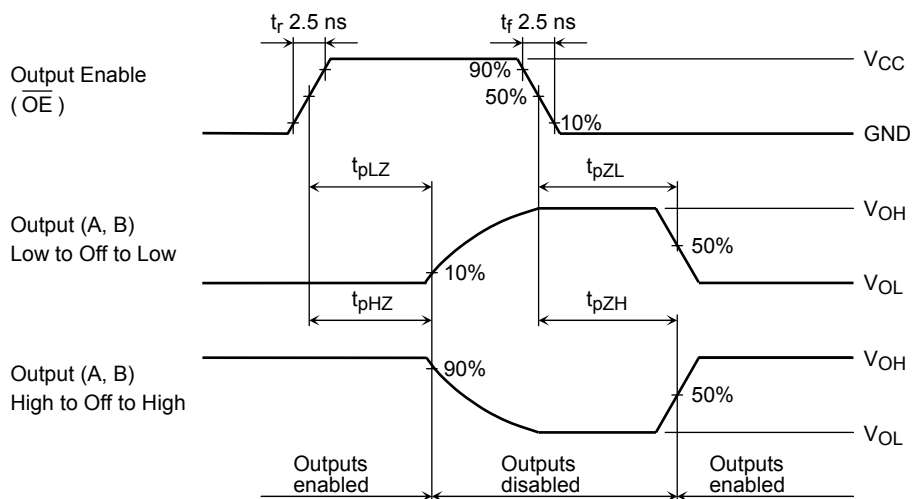
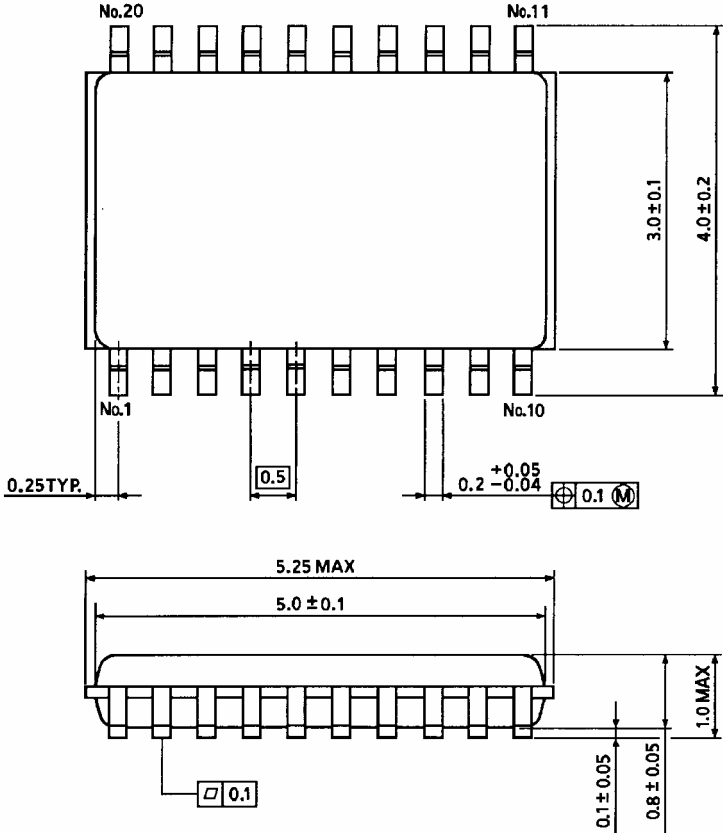

**Figure 3  $t_{pLZ}$ ,  $t_{pHZ}$ ,  $t_{pZL}$ ,  $t_{pZH}$**

Package Dimensions

VSSOP20-P-0030-0.50

Unit : mm



Weight: 0.03 g (typ.)

**RESTRICTIONS ON PRODUCT USE**

20070701-EN

- The information contained herein is subject to change without notice.
- TOSHIBA is continually working to improve the quality and reliability of its products. Nevertheless, semiconductor devices in general can malfunction or fail due to their inherent electrical sensitivity and vulnerability to physical stress. It is the responsibility of the buyer, when utilizing TOSHIBA products, to comply with the standards of safety in making a safe design for the entire system, and to avoid situations in which a malfunction or failure of such TOSHIBA products could cause loss of human life, bodily injury or damage to property.  
In developing your designs, please ensure that TOSHIBA products are used within specified operating ranges as set forth in the most recent TOSHIBA products specifications. Also, please keep in mind the precautions and conditions set forth in the "Handling Guide for Semiconductor Devices," or "TOSHIBA Semiconductor Reliability Handbook" etc.
- The TOSHIBA products listed in this document are intended for usage in general electronics applications (computer, personal equipment, office equipment, measuring equipment, industrial robotics, domestic appliances, etc.). These TOSHIBA products are neither intended nor warranted for usage in equipment that requires extraordinarily high quality and/or reliability or a malfunction or failure of which may cause loss of human life or bodily injury ("Unintended Usage"). Unintended Usage include atomic energy control instruments, airplane or spaceship instruments, transportation instruments, traffic signal instruments, combustion control instruments, medical instruments, all types of safety devices, etc.. Unintended Usage of TOSHIBA products listed in this document shall be made at the customer's own risk.
- The products described in this document shall not be used or embedded to any downstream products of which manufacture, use and/or sale are prohibited under any applicable laws and regulations.
- The information contained herein is presented only as a guide for the applications of our products. No responsibility is assumed by TOSHIBA for any infringements of patents or other rights of the third parties which may result from its use. No license is granted by implication or otherwise under any patents or other rights of TOSHIBA or the third parties.
- Please contact your sales representative for product-by-product details in this document regarding RoHS compatibility. Please use these products in this document in compliance with all applicable laws and regulations that regulate the inclusion or use of controlled substances. Toshiba assumes no liability for damage or losses occurring as a result of noncompliance with applicable laws and regulations.