

# TOSHIBA

## INSTRUCTION MANUAL

### CCD CAMERA

# IK-SX1L/IK-SX1

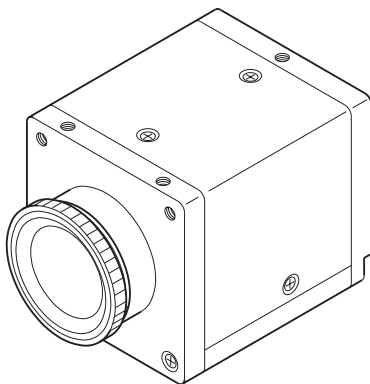

#### For Customer Use

Enter below the Serial No. which is located on the bottom of the cabinet. Retain this information for future reference.

Model No.: IK-SX1L

IK-SX1

Serial No.: \_\_\_\_\_

#### WARNING

This is a Class A of EN55022 product. In a domestic environment this product may cause radio interference in which case the user may be required to take adequate measures.

#### INFORMATION

This equipment has been tested and found to comply with the limits for a Class A digital device, pursuant to Part 15 of the FCC Rules. These limits are designed to provide reasonable protection against harmful interference when the equipment is operated in a commercial environment. This equipment generates, uses, and can radiate radio frequency energy and, if not installed and used in accordance with the instruction manual, may cause harmful interference to radio communications. Operation of this equipment in a residential area is likely to cause harmful interference in which case the user will be required to correct the interference at his own expense.

**USER-INSTALLER CAUTION:** Your authority to operate this FCC verified equipment could be voided if you make changes or modifications not expressly approved by the party responsible for compliance to Part 15 of the FCC rules.



This Class A digital apparatus complies with Canadian ICES-003.

Cet appareil numérique de la classe A est conforme à la norme NMB-003 du Canada.

# Safety precautions

Read the following safety precautions carefully before using the product. These instructions contain valuable information on safe and proper use that will prevent harm and damage to the operator and other persons. Make sure that you fully understand the following details (indications, graphic symbols) before proceeding to the main descriptions in this manual.



## Indication definitions

Indication	Meaning
 Warning	This indicates that ignoring this label and/or misoperation of the product may cause serious personal injury or even death.
 Caution	This indicates that ignoring this label and/or misoperation of the product may cause personal injury <sup>*1</sup> and/or material damage <sup>*2</sup> .







\*1: Bodily injury means injuries, burns and electric shock which does not require hospitalization or prolonged treatment.

\*2: Physical damage means extended harm to home, household effects.

## Graphic symbol definitions

Symbol	Meaning
	Indicates a prohibited action that must not be carried out. The actual prohibited action is indicated in the symbol or nearby graphically or described in text.
	Indicates a mandatory action that must be carried out surely. The actual mandatory action is indicated in the symbol or nearby graphically or described in text.

## Warning

-  **Do not use the product when abnormality occurs.**  
The use in the abnormality status such as emitting smoke from the product, smelling burning, being damaged by drop, invasion of foreign objects inside the product, etc., may cause fire and/or electric shock. Be always sure to disconnect the power plug from the electrical outlet (socket) at once and contact your dealer.
-  **Do not install the product where splashing of water may occur, such as outdoor, a bathroom, etc.**  
This may cause fire and/or electric shock.
-  **Do not repair, disassemble and/or modify by yourself.**  
This may cause fire and/or electric shock. Be always sure to contact your dealer for internal repair, check and cleaning of the product.
-  **Keep the rated voltage for the product.**  
The use of power supply voltage except for its rated voltage may cause fire and/or electrical shock. Please refer to "4. Connections".
-  **Do not put a vessel(s) filled with a liquid (flower vase, etc.).**  
If a liquid enters the product, a fire and/or electric shock may occur.
-  **Do not put the product in an unstable, slanting and/or vibrated place.**  
Drop and/or fail of the product may cause injury.
-  **Do not touch cords during a thunderstorm.**  
This might cause electric shock.

## **Caution**

- **Keep the followings when installing.**
  - Do not put the product on a flammable material such as carpet or blanket.
  - Do not put the product in a narrow space, since the heat generated from the product may be difficult to emanate.
  - Do not put a flammable material on the product.If you do not keep above, the heat generated by the product may cause fire.

---

- **Do not put the product in direct sunshine and/or high temperature.**  
The temperature rise inside the product may cause fire.

---

- **Do not put the product in a moist or dusty place such as a bathroom, a place close to a humidifier, etc.**  
This may cause fire and/or electric shock.

---

- **Do not put the product in a moist, soot and/or dusty place.**  
Do not put the product where a soot and steam may occur, such as a kitchen, etc., or in a dusty place. This may cause fire and/or electric shock.

---

- **Do not shoot the sun with the lens and do not put the lens in the place exposed to an intensive light, such as the sunshine, etc.**  
Focusing of the light may cause injury of eye and/or fire.

---

- **Do not put the product in your mouse and do not swallow it.**  
This may cause suffocation and/or injury.

---

- **Ask your dealer to perform a periodical check and internal cleaning (approx. once every five years).**  
Dust inside the product may cause fire and/or trouble. For check and cleaning cost, please consult your dealer.

## **Disclaimer**

We disclaim any responsibility and shall be held harmless for any damages or losses incurred by the user in any of the following cases:

1. Fire, earthquake or any other act of God; acts by third parties; misuse by the user, whether intentional or accidental; use under extreme operating conditions.
2. Malfunction or non-function resulting in indirect, additional or consequential damages, including but not limited to loss of expected income and suspension of business activities.
3. Incorrect use not in compliance with instructions in this instruction manual.
4. Malfunctions resulting from misconnection to other equipment.
5. Repairs or modifications made by the user or caused to be made by the user and carried out by an unauthorized third party.
6. Notwithstanding the foregoing, Toshiba's liabilities shall not, in any circumstances, exceed the purchase price of the product.

# TABLE OF CONTENTS

1. CAUTIONS ON USE AND INSTALLATION .....	5
2. COMPONENTS .....	5
3. CAMERA PARTS AND FUNCTIONS .....	6
4. CONNECTIONS .....	7
4.1. Standard Connection .....	7
4.2. Cautions on Connection .....	7
4.3. Connector Pin Assignments .....	7
5. OPERATION .....	8
6. Setting .....	9
6.1 Gain switch .....	9
6.2 Synchronizing mode selector switch .....	9
6.3 Mode setting switch .....	9
6.4 Electric shutter speed switch .....	10
6.5 Partial scanning switch .....	10
7. Operation mode .....	11
7.1 Internal synchronization .....	11
7.2 Internal synchronization draft mode .....	11
7.3 Internal synchronization partial readout .....	12
7.4 1-pulse trigger .....	13
7.5 1-pulse trigger partial readout .....	13
7.6 Pulse width trigger .....	14
7.7 Pulse width trigger partial readout .....	14
8. Partial Scanning .....	15
8.1 Scanning area 1/15 (70 lines, 60 fps) .....	15
8.3 Scanning area 1/2 (560 lines, 24 fps) .....	15
8.2 Scanning area 1/2.6 (400 lines, 30 fps) .....	15
8.4 Scanning area 2/3 (700 lines, 20 fps) .....	15
9. Timing Chart .....	16
9-1 All pixel scanning .....	16
9.2 Draft mode .....	17
9.3 Partial Scanning .....	18
10. TROUBLESHOOTING CHART .....	20
11. SPECIFICATIONS .....	20
12. EXTERIOR VIEW .....	21

# 1. CAUTIONS ON USE AND INSTALLATION

- **Carefully handle the units.**

Do not drop, or give a strong shock or vibration to the camera. This may cause problems. Treat the camera cables carefully to prevent cable problems, such as cable breakdown and loosened connections.

- **Do not shoot intense light.**

If there is an intense light at a location on the screen such as a spot light, a blooming and smearing may occur.

When intense light enters, vertical stripes may appear on the screen. This is not a malfunction. Ghosts may occur when there is an intense light near the object. In this case, change the shooting angle.

- **Install the camera in a location free from noise.**

If the camera or the cables are located near power utility lines or a TV, etc. undesirable noise may appear on the screen. In such a case, try to change the location of the camera or the cable wiring.

- **Moire**

When thin stripe patterns are shooted, stripe patterns that are not actually there (moire) may appears as interference stripes. This is not a malfunction.

- **Operating ambient temperature and humidity.**

Do not use the camera in places where temperature and humidity exceed the specifications. Picture quality will lower and internal parts may be damaged.

Be particularly careful when using in places exposed to direct sunlight. When shooting in hot places, depending on the conditions of the object and the camera (for example when the gain is increased), noise in the form of vertical strips or white dots may occur. This is not a malfunction.

- **Handling of the protection cap.**

Keep the protection cap away from children. Children may put them into mouth or swallow them accidentally. The protection cap protects the image sensing plane when the lens is removed from the camera, do not throw away.

- **When not using the camera for a long-time.**

Stop supplying power.

- **When cleaning the camera**

Always turn off the power and clean with a piece of dry cloth. If necessary, gently wipe with a cloth dampened with thinned detergent. Do not use benzine, alcohol, thinner, etc. If used, coating and printed letters may be discolored. When cleaning the lens, use a lens cleaning paper, etc.

## 2. COMPONENTS

(1) Camera .....	1
(2) Accessories	
Instruction manual .....	1

## 3. CAMERA PARTS AND FUNCTIONS

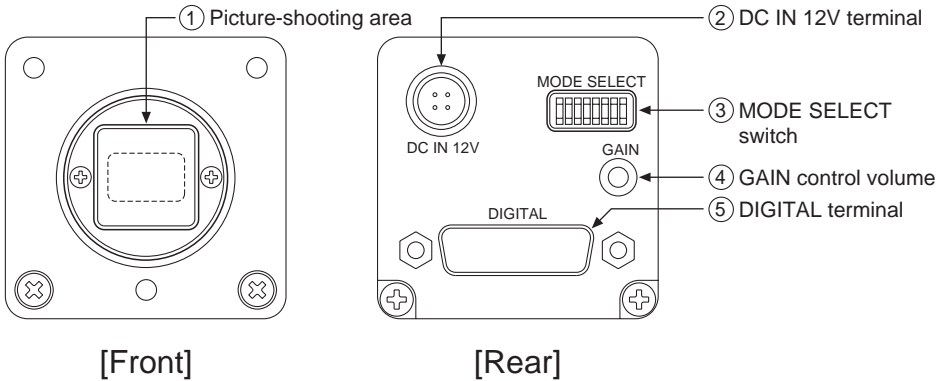

### ① Picture-shooting area

The protection cap is attached on the lens mount portion. After removing the cap, mount the lens. Be careful not to scratch or touch the optical area.

### ② DC IN 12V terminal

Accept a DC power input (12V).

### ③ MODE SELECT switch

Selects the gain mode (OFF/ON).  
Selects the synchronizing output signal (HD, VD/LEN, FEN).  
Selects the operation mode.  
Selects the electric shutter exposure time.  
Selects the partial scanning mode.

### ④ GAIN control volume

Adjusts the video signal gain when the gain mode is set to ON with the MODE SELECT switch ③.

### ⑤ DIGITAL terminal

IK-SX1L: Outputs the EIA RS-644 LVDS 8-bit digital signal. Enters a trigger signal.  
IK-SX1: Outputs the Camera Link signal (8-bit digital signal). Enters a trigger signal.

# 4. CONNECTIONS

## 4.1. Standard Connection

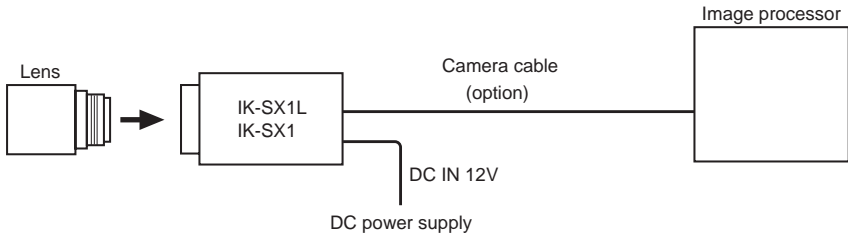

## 4.2. Cautions on Connection

- When connecting the camera cables, be sure to turn off the camera and the other equipment connected.
- The lens for high resolution is recommended.

When using another lens, the best camera performance of this camera may not be obtained.

(For example, low resolution may occur, and flare, ghost or shading may occur)

- For DC power supply connecting to DC IN 12V terminal, use UL listed and/or CSA approved ungrounding type AC adaptor with the specifications described below.

Power supply voltage: DC12V±10%

Current rating: More than 830 mA, Less than 2.5A

Ripple voltage: Less than 50 mV(p-p)

Connector: HR10A-7P-4S by HIROSE electronics Co. Ltd    Pins 1, 2: +12V

Pins 3, 4: GND

## 4.3. Connector Pin Assignments

<IK-SX1L, IK-SX1>

DC IN 12V

1	+12V
2	+12V
3	GND
4	GND

Hirose Electronics Co. Ltd. HR10A-7P-4PB

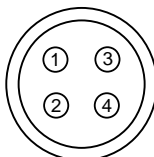

## <IK-SX1L>

### DIGITAL

1	+D0 (Video Data (LSB))	15	-D0 (Video Data (LSB))
2	+D1 (Video Data)	16	-D1 (Video Data)
3	+D2 (Video Data)	17	-D2 (Video Data)
4	+D3 (Video Data)	18	-D3 (Video Data)
5	+D4 (Video Data)	19	-D4 (Video Data)
6	+D5 (Video Data)	20	-D5 (Video Data)
7	+D6 (Video Data)	21	-D6 (Video Data)
8	+D7 (Video Data (MSB))	22	-D7 (Video Data (MSB))
9	+VD/+FEN	23	-VD/-FEN
10	+HD/+LEN	24	-HD/-LEN
11	+PCK (Pixel clock)	25	-PCK (Pixel clock)
12	Trigger in (Trigger input)	26	CC2 (Partial Scanning setting)
13	CC3 (Partial Scanning setting)	27	CC4 (Partial Scanning setting)
14	GND	28	GND

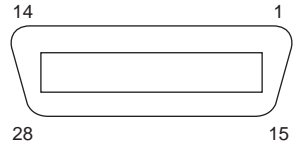

Hirose Electronics Co. Ltd.  
HR10A-28S

## <IK-SX1>

### DIGITAL

1	GND	14	GND
2	-X0	15	+X0
3	-X1	16	+X1
4	-X2	17	+X2
5	-Xclk	18	+Xclk
6	-X4	19	+X4
7	NC	20	NC
8	NC	21	NC
9	-CC1 (Trigger input)	22	+CC1 (Trigger input)
10	+CC2 (Partial Scanning setting)	23	-CC2 (Partial Scanning setting)
11	-CC3 (Partial Scanning setting)	24	+CC3 (Partial Scanning setting)
12	+CC4 (Partial Scanning setting)	25	-CC4 (Partial Scanning setting)
13	GND	26	GND

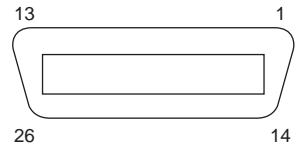

3M  
10226-1210

## 5. OPERATION

- ① Referring to the item "4. CONNECTION", connect each equipment correctly.
- ② Turn on the connected equipment and the camera.
- ③ Pointing the lens at the object, operate the lens iris adjustment, focus adjustment, etc.
- ④ Set the necessary mode by referring to "6. Setting".

## 6. Setting

### MODE SELECT switch

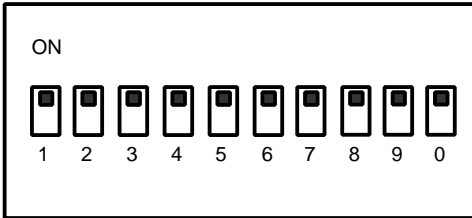

- No. 1: Gain ON/OFF
- No. 2: Synchronizing signal selection
- No. 3: Mode setting
- No. 4: Mode setting
- No. 5: Mode setting
- No. 6: Electric shutter speed
- No. 7: Electric shutter speed
- No. 8: Electric shutter speed
- No. 9: Partial scanning area
- No. 10: Partial scanning area

### 6.1 Gain switch

Use this switch when the image is dark even if the lens iris is fully opened. When the gain ON is set, adjust the video signal level with the gain control volume on the rear panel.

Mode	No.1
Gain OFF	OFF
Gain ON	ON (-3 to 12dB variable with the control volume)

### 6.2 Synchronizing mode selector switch

This selects the DIGITAL terminal synchronizing signals output.

Mode	No.2
HD/VD	OFF
LEN/FEN	ON

### 6.3 Mode setting switch

This sets the operation mode.

Mode	No.3	No.4	No.5
Internal synchronization	OFF	OFF	OFF
1-pulse trigger	OFF	OFF	ON
Pulse width trigger	OFF	ON	OFF
Internal synchronization draft mode	OFF	ON	ON
Internal synchronization partial scanning*	ON	OFF	OFF
1-pulse trigger partial scanning	ON	OFF	ON
Pulse width trigger partial scanning	ON	ON	OFF
Internal synchronization partial scanning*	ON	ON	ON

\* Same mode

## 6.4 Electric shutter speed switch

This sets the electric shutter speed and the exposure time for the 1-pulse trigger.

Electric shutter speed	No.6	No.7	No.8
1/15	OFF	OFF	OFF
1/100	OFF	OFF	ON
1/500	OFF	ON	OFF
1/1000	OFF	ON	ON
1/2000	ON	OFF	OFF
1/4000	ON	OFF	ON
1/10000	ON	ON	OFF
1/50000	ON	ON	ON

## 6.5 Partial scanning switch

This sets the partial scanning area.

(Partial scanning can also be set from the DIGITAL terminal on the rear panel.)

Operation mode	No.9	No.0
Scanning area 1/15 (70 lines, 60 fps)	OFF	OFF
Scanning area 1/2.6 (400 lines, 30 fps)	OFF	ON
Scanning area 1/2 (560 lines, 24 fps)	ON	OFF
Scanning area 2/3 (700 lines, 20 fps)	ON	ON

Setting from the DIGITAL terminal

(No.9 and No.0 of the MODE SELECT switch become ineffective.)

Switch No. 3 on the rear panel	DIGITAL terminal CC2	DIGITAL terminal CC3	DIGITAL terminal CC4	Operation mode
OFF	H	H	H	Scanning area 1/15 (70 lines, 60 fps)
OFF	H	H	L	Scanning area 1/2.6 (400 lines, 30 fps)
OFF	H	L	H	Scanning area 1/2 (560 lines, 24 fps)
OFF	H	L	L	Scanning area 2/3 (700 lines, 20 fps)
OFF	L	*	*	Partial scanning OFF

\*: Don't care. (Either L or H is OK.)

# 7. Operation mode

## 7.1 Internal synchronization

Horizontal synchronization: 15.998 kHz (28.63636 MHz x 1790 clocks)

Vertical synchronization: 15 fps (14.98 Hz = 28.63636 MHz x 1790 clocks x 1068 lines)

Output signal: Video data, pixel clock, FEN/VD, LEN/HD

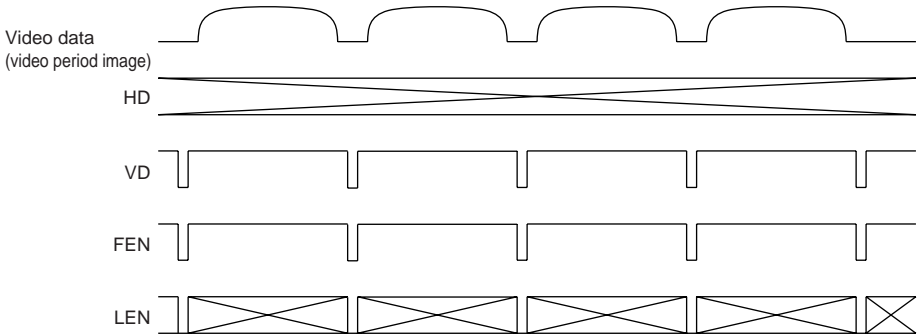

## 7.2 Internal synchronization draft mode

When the draft mode is set, the frame rate can be increased by thinning out the image when outputting.

Horizontal synchronization: 15.998 kHz

Vertical synchronization: 60 fps

Output signal: Video data, pixel clock, FEN/VD, LEN/HD

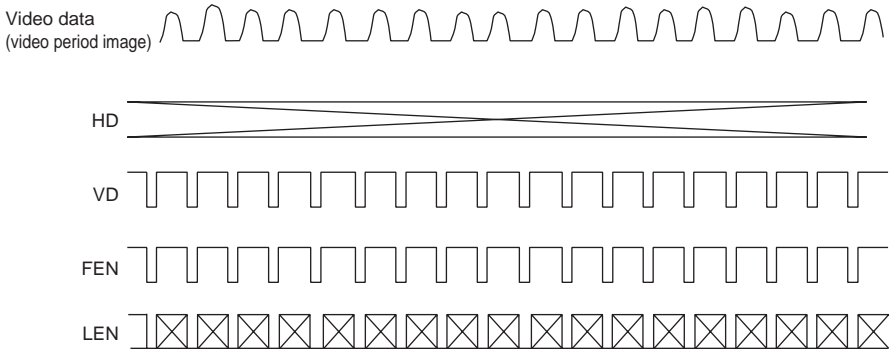

Draft mode OFF

All pixels are independently read out.

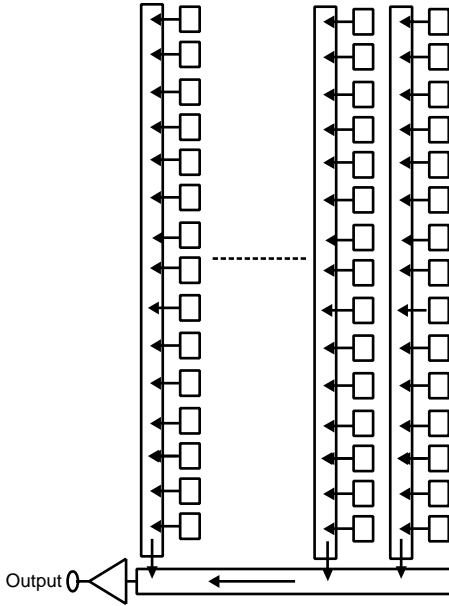

Draft mode ON

Pixels are thinned out and read out.

(Only the white pixel is read out.)

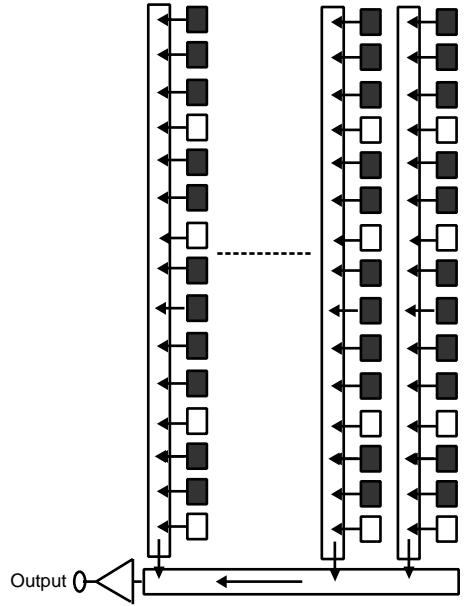

### 7.3 Internal synchronization partial readout

When the partial scanning is set, the frame rate can be increased by decreasing the number of output lines. The number of settable output lines is 70/400/560/700 lines. For the detail, refer to "8. Partial Scanning".

Horizontal synchronization: 15.998 kHz (28.63636 MHz x 1790 clocks)

Output signal: Video data, pixel clock, FEN/VD, LEN/HD

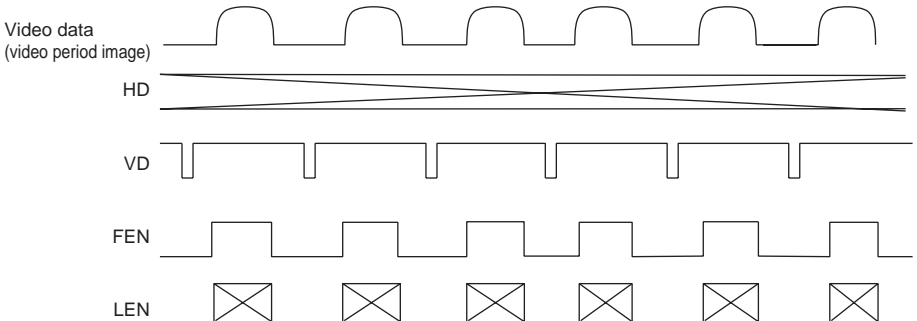

## 7.4 1-pulse trigger

Exposure starts by the trigger signal input to the DIGITAL terminal, and outputs a 1-frame image. The shutter speed (exposure period) is set with the MODE SELECT switch No. 6 - No. 8 on the rear panel.

Input signal: Trigger

Output signal: Video data, pixel clock, FEN/VD, LEN/HD

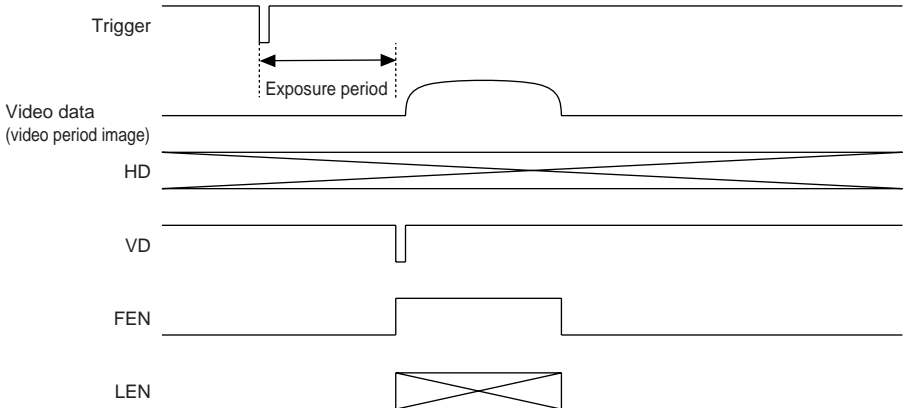

## 7.5 1-pulse trigger partial readout

This is the mode for partial scanning by the 1-pulse trigger operation.

Input signal: Trigger

Output signal: Video data, pixel clock, FEN/VD, LEN/HD

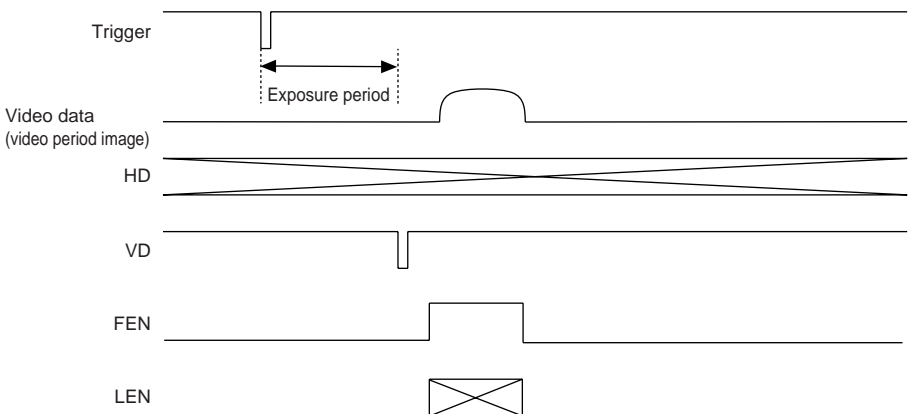

## 7.6 Pulse width trigger

This is the mode to set the exposure period by the pulse width of the trigger signal applied to the DIGITAL terminal. This accumulates electric charge taking the trigger signal "L" period as exposure time, and develops a 1-frame image. The trigger signal minimum pulse width ("L" period) is  $20\mu\text{s}$  ( $1/50000\text{s}$ ).

Input signal: Trigger

Output signal: Video data, pixel clock, FEN/VD, LEN/HD

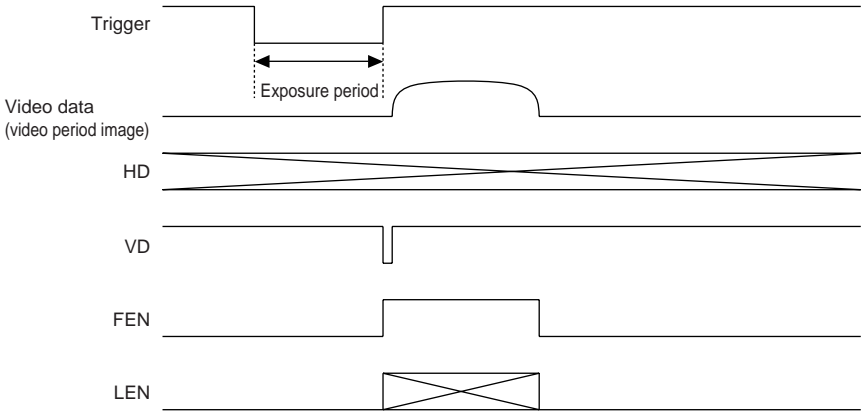

## 7.7 Pulse width trigger partial readout

This is the mode for partial scanning by the pulse width trigger operation.

Input signal: Trigger

Output signal: Video data, pixel clock, FEN/VD, LEN/HD

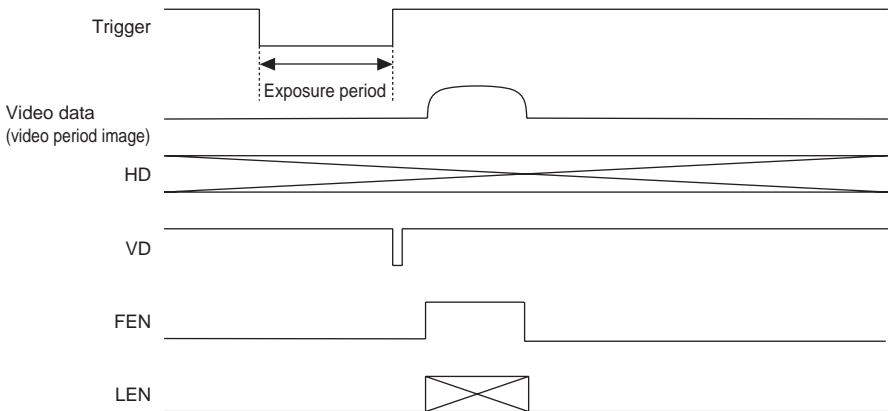

## 8. Partial Scanning

The set number of vertical lines is partially scanning, and the frame rate can be increased.

### 8.1 Scanning area $1/15$ (70 lines, 60 fps)

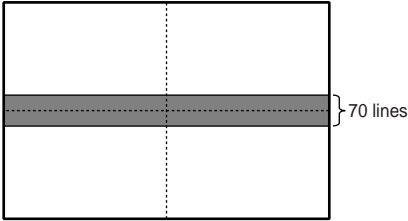

### 8.2 Scanning area $1/2.6$ (400 lines, 30 fps)

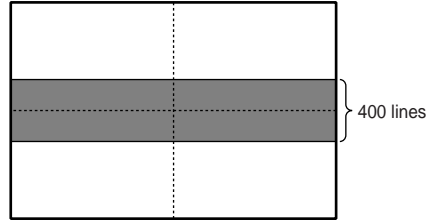

### 8.3 Scanning area $1/2$ (560 lines, 24 fps)

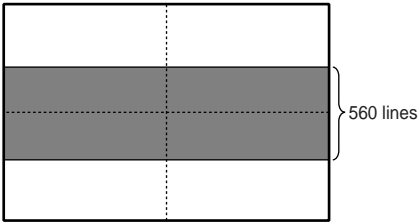

### 8.4 Scanning area $2/3$ (700 lines, 20 fps)

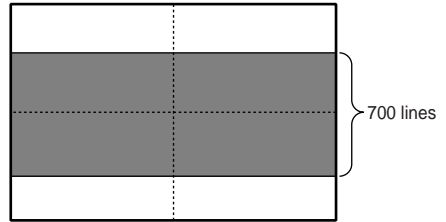

# 9. Timing Chart

## 9-1 All pixel scanning

① V-rate

Internal synchronization

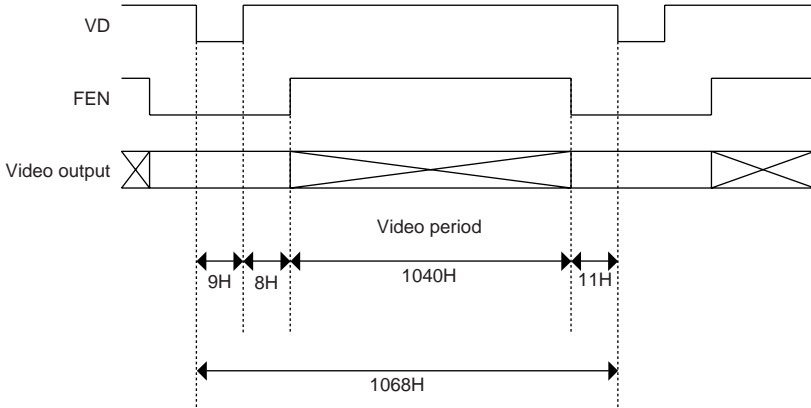

1-pulse trigger, pulse width trigger

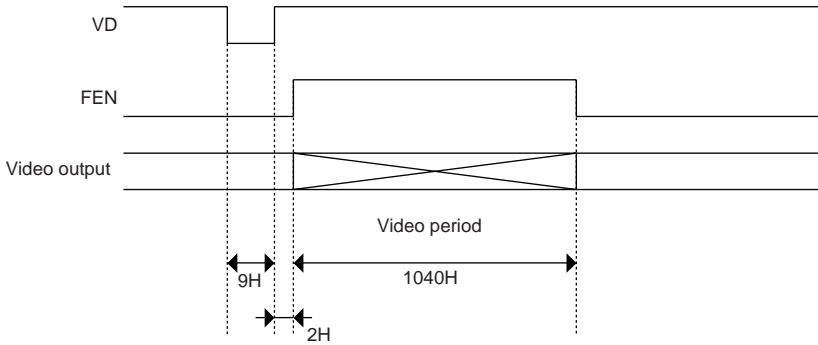

② H-rate

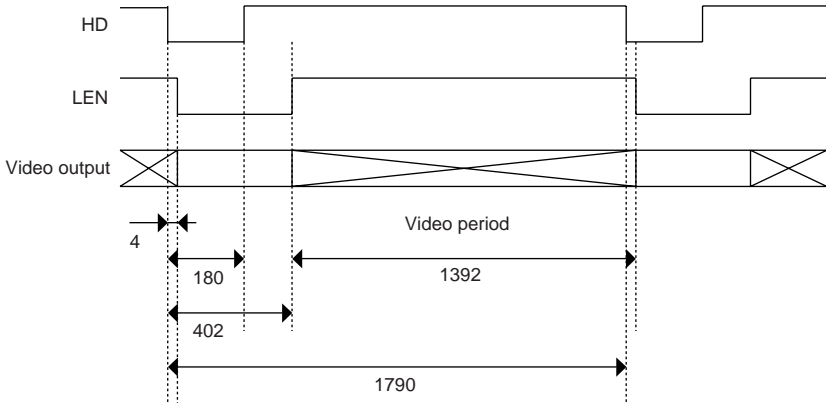

The digits indicate the number of clocks.  
1 clock = 34.9 ns (28.63636 MHz)

**9.2 Draft mode**

① V-rate

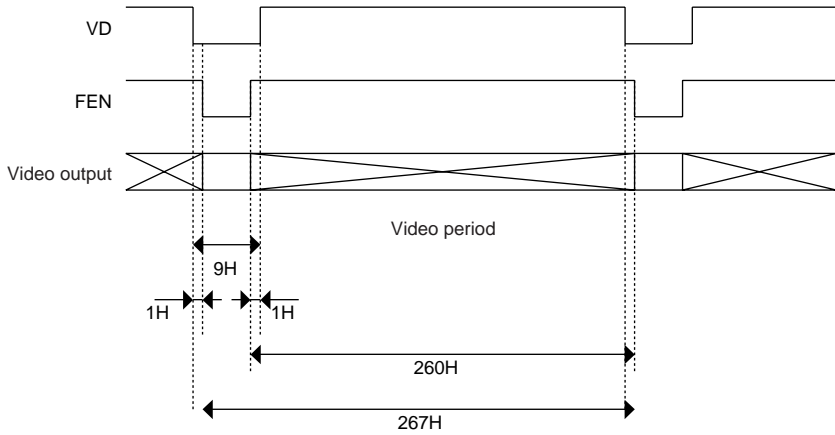

② H-rate

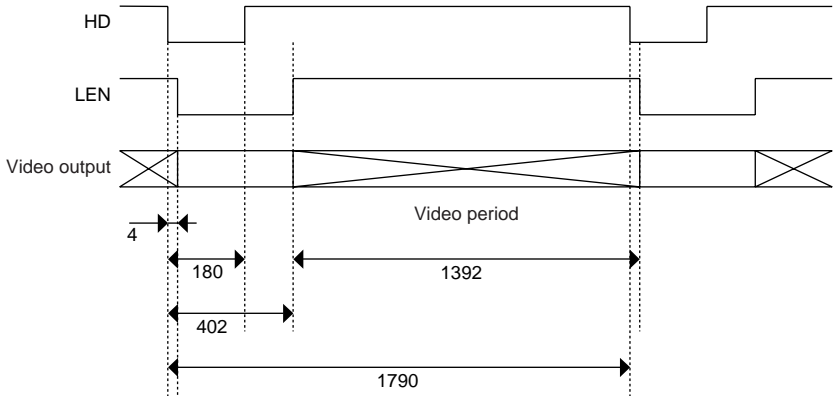

The digits indicate the number of clocks.  
 1 clock = 34.9 ns (28.63636 MHz)

### 9.3 Partial scanning

① V-rate

Internal synchronization

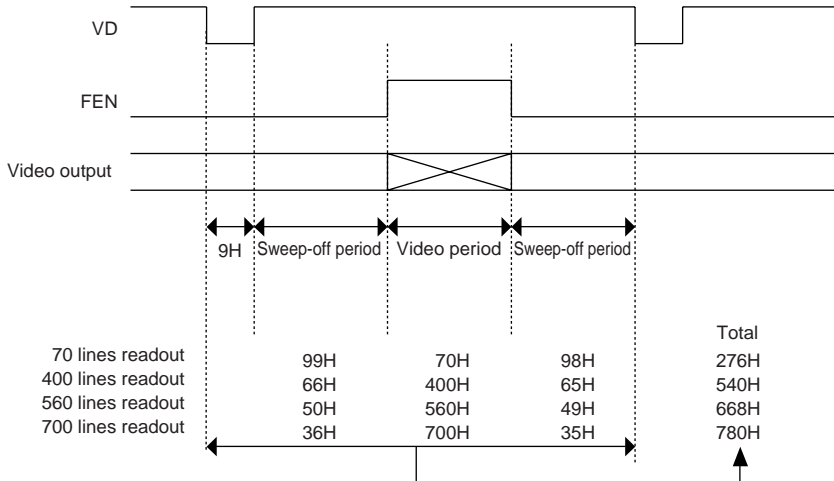

1-pulse trigger, pulse width trigger

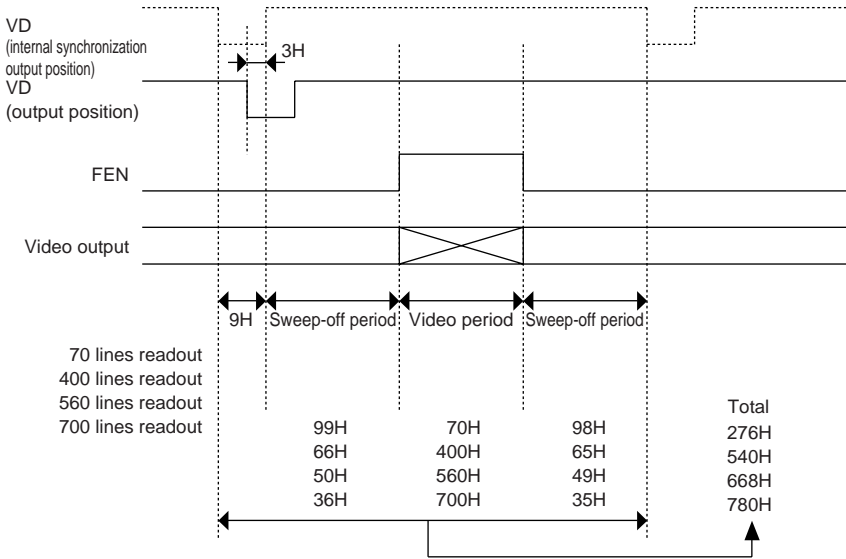

② H-rate

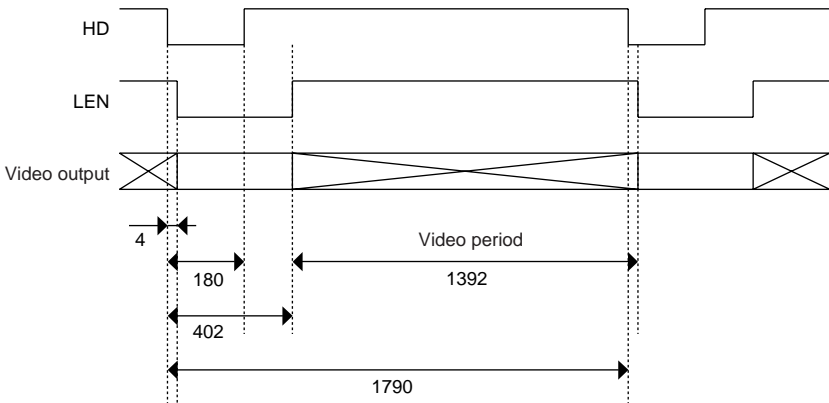

The digits indicate the number of clocks.  
1 clock = 34.9 ns (28.63636 MHz)

# 10. TROUBLESHOOTING CHART

Symptoms	Possible causes
No image	<ul style="list-style-type: none"> <li>• Is power properly supplied?</li> <li>• Is the lens iris adjusted properly?</li> <li>• Is the CRT monitor adjusted properly?</li> <li>• Is the shutter mode set correctly?</li> </ul>

# 11. SPECIFICATIONS

Power supply	DC12 ± 10%
Power consumption	Approx. 1.7W
Image sensor (Effective pixels)	2/3inch Progressive Scanning CCD (Horizontal: 1392 pixels, Vertical: 1040 pixels)
Scanning system	Noninterlace
Scan frequency	Horizontal: 15.998 kHz, Vertical: 14.98 Hz
Sensitivity	F16 600 lx (GAIN OFF)
Lens mount	C mount
Ambient temperature	32 to 104° F (0 to 40°C)
Ambient humidity	Less than 90%
Weight	Approx. 4.77 oz (135g)
External dimension	1.73" (W) x 1.73" (H) x 2.05" (D) (44 (W) x 44 (H) x 52 (D) mm) (except for protruded portion)
Gain	ON (-3 to 12 dB), OFF (0 dB)
Video output	IK-SX1L: EIA RS-644 LVDS video 8-bit digital output IK-SX1: Camera link video 8-bit digital output
Electric shutter	1/15s, 1/100s, 1/500s, 1/1000s, 1/2000s, 1/4000s, 1/10000s, 1/50000s
Mode	Internal synchronization, internal synchronization draft, internal synchronization partial scanning 1-Pulse trigger, 1-pulse trigger partial scanning Pulse width trigger, Pulse width trigger partial scanning
Partial scanning	Scanning area 1/15 (70 lines, 6 fps) Scanning area 1/2.6 (400 lines, 30 fps) Scanning area 1/2 (560 lines, 24 fps) Scanning area 2/3 (700 lines, 20 fps)
Sync signal output	HD, VD/LEN, FEN LVDS format (IK-SX1L) Camera Link format (IK-SX1) PCK (28.63636 MHz) LVDS format (IK-SX1L) Camera Link format (IK-SX1)
External trigger input	TRIGGER; Low level: Less than 0.4V, High level: 3.4 to 5V Negative More than 20µs pulse width
Optional parts	EXC-SX03M (cable for IK-SX1L), EXC-SX03A (cable for IK-SX1L), EXC-CL05 (cable for IK-SX1), etc.

\* Design and specifications are subject to change without notice.

# 12. EXTERIOR VIEW

Dimensions: mm [inch]

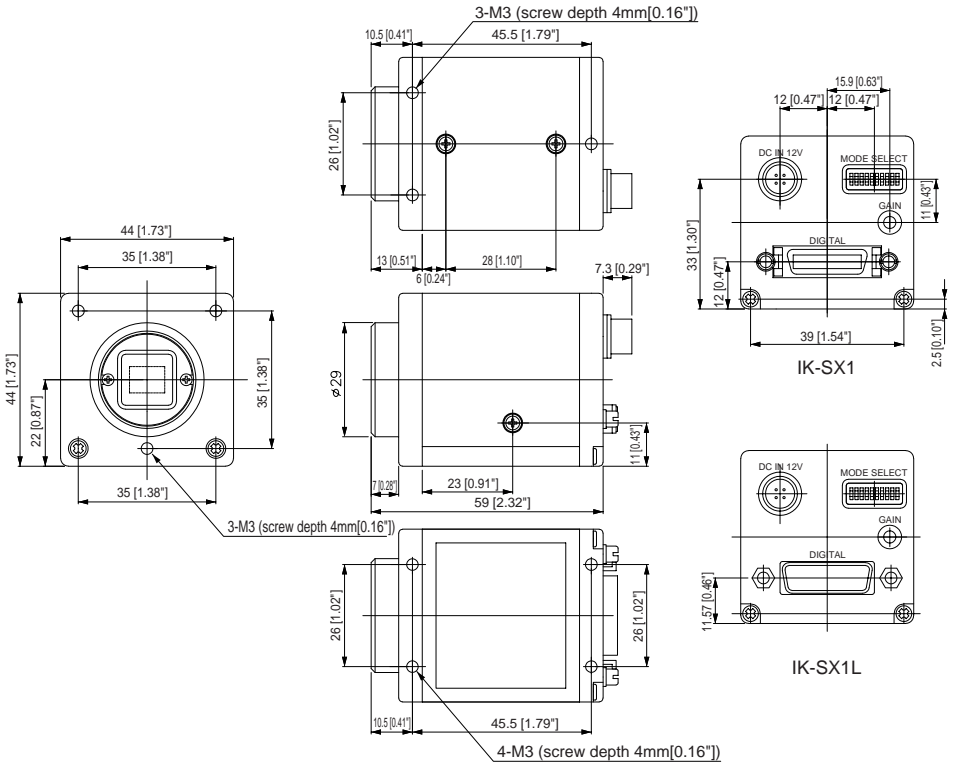

# Memo

# Memo

## LIMITED WARRANTY CCD CAMERA

The Imaging Systems Division of Toshiba America Information Systems, Inc. ("ISD") makes the following limited warranties with regard to this CCD Camera ("Product"). These limited warranties extend to the Original End-User ("You[er]").

**One (1) Year Limited Warranty of Labor and Parts:** ISD warrants that this Product will perform in accordance with specifications for a period of one (1) year from the date of purchase by the Original End-User. During this one (1) year period, ISD will repair or replace the Product, if it does not perform as warranted. In order to take advantage of this Limited Warranty, You must: (a) deliver the Product to an ISD Authorized Service Provider ("ASP"); and (b) pay all transportation and insurance charges for shipment of the Product to the ASP. ISD reserves the right to substitute factory refurbished parts in place of those in need of repair.

**Instruction Manual (Owner's Manual):** You should read the Instruction Manual (Owners Manual) thoroughly before operating this Product. Before seeking warranty service, you should check the troubleshooting guide in the Instruction Manual (Owner's Manual) and follow the instructions to correct the problem.

**Your Responsibilities:** This Limited Warranty is subject to the following conditions:

1. You must provide the bill of sale or proof of purchase at the time that warranty service is required.
2. You must notify an ASP within thirty (30) days after You discover that the Product does not perform in accordance with specifications during the Limited Warranty period.
3. All warranty servicing of this product must be made by an ISD Authorized Service Provider.
4. You must pack the Product in its original carton using the original packing material, then insert the original carton containing the Product into another carton with additional packing material before shipping the Product to an ASP.

### DISCLAIMERS:

**ALL OTHER EXPRESS OR IMPLIED WARRANTIES ON THIS PRODUCT, INCLUDING THE IMPLIED WARRANTIES OF MERCHANTABILITY AND FITNESS FOR A PARTICULAR PURPOSE, ARE HEREBY DISCLAIMED. SOME STATES DO NOT ALLOW THE EXCLUSION OF IMPLIED WARRANTIES OR LIMITATIONS ON HOW LONG AN IMPLIED WARRANTY LASTS, SO THE ABOVE LIMITATIONS MAY NOT APPLY TO YOU.**

**IF THIS PRODUCT IS NOT IN GOOD WORKING ORDER AS WARRANTED ABOVE, YOUR SOLE AND EXCLUSIVE REMEDY SHALL BE THE REPAIR OR REPLACEMENT OF THE PRODUCT. IN NO EVENT WILL ISD OR ITS PARENT COMPANY OR ANY ASP BE LIABLE TO YOU OR ANY THIRD PARTY FOR ANY DAMAGES IN EXCESS OF THE PURCHASE PRICE OF THE PRODUCT. THIS LIMITATION APPLIES TO DAMAGES OF ANY KIND, INCLUDING ANY DIRECT OR INDIRECT DAMAGES, LOST PROFITS, LOST SAVINGS OR OTHER SPECIAL, INCIDENTAL, EXEMPLARY OR CONSEQUENTIAL DAMAGES, WHETHER FOR BREACH OF CONTRACT, TORT OR OTHERWISE, OR WHETHER ARISING OUT OF THE USE OF OR INABILITY TO USE SUCH PRODUCT, EVEN IF TAIS, ITS PARENT COMPANY, OR AN ASP HAS BEEN ADVISED OF THE POSSIBILITY OF SUCH DAMAGES OR OF ANY CLAIM BY ANY OTHER PARTY. SOME STATES DO NOT ALLOW THE EXCLUSION OR LIMITATION OF INCIDENTAL OR CONSEQUENTIAL DAMAGES FOR SOME PRODUCTS, SO THE ABOVE LIMITATIONS OR EXCLUSIONS MAY NOT APPLY TO YOU.**

**THIS WARRANTY GIVES YOU SPECIFIC LEGAL RIGHTS, AND YOU MAY ALSO HAVE OTHER RIGHTS WHICH MAY VARY FROM STATE TO STATE.**

**THIS LIMITED WARRANTY SHALL BE VOID IF THE PRODUCT OR PARTS HAVE BEEN SUBJECTED TO MISUSE, ABUSE, ACCIDENT, IMPROPER INSTALLATION, IMPROPER MAINTENANCE, OR USE IN VIOLATION OF ISD'S WRITTEN INSTRUCTIONS, OR WHERE THE PRODUCT HAS BEEN ALTERED OR MODIFIED WITHOUT ISD'S PRIOR AUTHORIZATION, OR UPON THE REMOVAL OR ALTERATION OF ISD'S FACTORY SERIAL NUMBER. LABOR SERVICE CHARGES FOR PRODUCT INSTALLATION, SET UP AND ADJUSTMENT OF CONTROLS ARE NOT COVERED BY THIS LIMITED WARRANTY.**

**How to Obtain Warranty Service — Step-By-Step Procedures:** To obtain warranty service, You should:

1. Contact an ASP for warranty service within thirty (30) days after the Product fails to comply with specifications.
2. Arrange for shipment of the Product to an ASP
3. Securely pack the Product as described above, insure the carton, and include a letter explaining the problem and a copy of the bill of sale or proof of purchase.
4. Prepay all transportation and insurance costs.

**Questions?** If you have any questions, please check ISD's website or send an e-mail as follows:

Website: <http://www.toshiba.com/taisisd/indmed>

E-mail: [CCTVtech.support@tais.toshiba.com](mailto:CCTVtech.support@tais.toshiba.com)

No person, agent, distributor, dealer, authorized service provider, or company is authorized to change, modify, or extend the terms of this Limited Warranty in any manner whatsoever. The time within which an action must be commenced to enforce any obligation of ISD arising under this Limited Warranty or under any statute, or law of the United States or any state thereof, is hereby limited to one (1) year from the date You discover or should have discovered the problem. This limitation does not apply to implied warranties arising under state law. Some states do not permit limitation of the time within which You may bring an action beyond the limits provided by state law, so the above provision may not apply to You. This Limited Warranty gives You specific legal rights and You may also have other rights which vary from state to state.

TOSHIBA AMERICA INFORMATION SYSTEMS, INC.  
**Imaging Systems Division**  
9740 Irvine Boulevard, Irvine, CA 92618-1697  
Service Department: (949) 461-4989 & 4992

**TOSHIBA**