

TOSHIBA

Leading Innovation >>>

Integrated High Definition LED Television User's Guide:

42L6200U

47L6200U

55L6200U

47L7200U

55L7200U

If you need assistance:

Toshiba's Support Web site support.toshiba.com

Toshiba Customer Support Center:

Calling within the United States at (800) 631-3811

Calling from outside the United States at (949) 583-3050

For more information, see "Troubleshooting" on page 181 in this guide.

Owner's Record

The model number and serial number are on the back and side of your television. Record these numbers, whenever you communicate with your Toshiba dealer about this Television.

Model name: _____

Serial number: _____

Register your Toshiba Television at register.toshiba.com

Note: To display a High Definition picture, the TV must be receiving a High Definition signal (such as an over-the-air High Definition TV broadcast, a High Definition digital cable program, or a High Definition digital satellite program). For details, contact your TV antenna installer, cable provider, or satellite provider

GMA300007011
3/12

Dear Customer,

Thank you for purchasing this Toshiba LED TV. This manual will help you use the many exciting features of your new LED TV. Before operating your LED TV, carefully read this manual completely.

Safety Precautions

WARNING: TO REDUCE THE RISK OF FIRE OR ELECTRIC SHOCK, DO NOT EXPOSE THIS APPLIANCE TO RAIN OR MOISTURE.



The lightning flash with arrowhead symbol, within an equilateral triangle, is intended to alert the user to the presence of uninsulated "dangerous voltage" within the product's enclosure that may be of sufficient magnitude to constitute a risk of electric shock to persons.



The exclamation point within an equilateral triangle is intended to alert the user to the presence of important operating and maintenance (servicing) instructions in the literature accompanying the appliance.

WARNING

To prevent injury, this apparatus must be securely attached to the floor/wall in accordance with the installation instructions. See item 26) on page 4.

WARNING: If you decide to wall mount this television, always use a mounting bracket that has been Listed by an independent laboratory (such as UL, CSA, ETL) and is appropriate for the size and weight of this television. The use of inappropriate or non-Listed mounting brackets could result in serious bodily injury and/or property damage. See "To Display your LED TV using a Wall Bracket:" on page 5.

NOTE TO CATV INSTALLERS

This is a reminder to call the CATV system installer's attention to Article 820-40 of the U.S. NEC, which provides guidelines for proper grounding and, in particular, specifies that the cable ground shall be connected to the grounding system of the building, as close to the point of cable entry as practical. For additional antenna grounding information, see items 33) and 34) on page 4.

CHILD SAFETY:

It Makes A Difference How and Where You Use Your Flat Panel Display

Congratulations on your purchase! As you enjoy your new product, please keep these safety tips in mind:

The Issue

The home theater entertainment experience is a growing trend and larger flat panel displays are popular purchases. However, flat panel displays are not always supported on the proper stands or installed according to the manufacturer's recommendations.

- Flat panel displays that are inappropriately situated on dressers, bookcases, shelves, desks, speakers, chests or carts may fall over and cause injury.



TOSHIBA Cares!

- The consumer electronics industry is committed to making home entertainment enjoyable and safe.

Tune Into Safety

- One size does NOT fit all. Follow the manufacturer's recommendations for the safe installation and use of your flat panel display.
- Carefully read and understand all enclosed instructions for proper use of this product.
- Don't allow children to climb on or play with furniture and television sets.
- Don't place flat panel displays on furniture that can easily be used as steps, such as a chest of drawers.
- Remember that children can become excited while watching a program, especially on a "larger than life" flat panel display. Care should be taken to place or install the display where it cannot be pushed, pulled over, or knocked down.
- Care should be taken to route all cords and cables connected to the flat panel display so that they cannot be pulled or grabbed by curious children.



Wall Mounting: If you decide to wall mount your flat panel display, always:

- Use a mount that has been recommended by the display manufacturer and/or listed by an independent laboratory (such as UL, CSA, ETL).
- Follow all instructions supplied by the display and wall mount manufacturers.
- If you have any doubts about your ability to safely install your flat panel display, contact your retailer about professional installation.
- Make sure that the wall where you are mounting the display is appropriate. Some wall mounts are not designed to be mounted to walls with steel studs or old cinder block construction. If you are unsure, contact a professional installer.
- A minimum of two people are required for installation. Flat panel displays can be heavy.



www.CEA.org/safety

Important Safety Instructions

- 1) **Read these instructions.**
 - 2) **Keep these instructions.**
 - 3) **Heed all warnings.**
 - 4) **Follow all instructions.**
-
- 5) **Do not use this apparatus near water.**
-
- 6) **Clean only with dry cloth.**
-
- 7) **Do not block any ventilation openings.** Install in accordance with the manufacturer's instructions.
-
- 8) **Do not install near any heat sources** such as radiators, heat registers, stoves, or other products (including amplifiers) that produce heat.
-
- 9) **Do not defeat the safety purpose of the polarized or grounding type plug.** A polarized plug has two blades with one wider than the other. A grounding type plug has two blades and a third grounding prong. The wide blade or the third prong are provided for your safety. If the provided plug does not fit into your outlet, consult an electrician for replacement of the obsolete outlet.

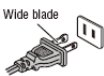

- 10) **Protect the power cord** from being walked on or pinched, particularly at plugs, convenience receptacles, and the point where they exit from the apparatus.
-
- 11) **Only use attachments/accessories specified by the manufacturer.**
-
- 12) **Use only with the cart, stand, tripod, bracket, or table specified by the manufacturer, or sold with the apparatus.** When a cart is used, use caution when moving the cart/apparatus combination to avoid injury from tip-over.



- 13) **Unplug this apparatus during lightning storms or when unused for long periods of time.**
-
- 14) **Refer all servicing to qualified service personnel.** Servicing is required when the apparatus has been damaged in any way, such as power-supply cord or plug is damaged, liquid has been spilled or objects have fallen into the apparatus, the apparatus has been exposed to rain or moisture, does not operate normally, or has been dropped.

Additional Safety Precautions

- 14a) **CAUTION:** If the TV is dropped and the cabinet or enclosure surface has been damaged or the TV does not operate normally, take the following precautions:
- ALWAYS turn off the TV and unplug the power cord to avoid possible electric shock or fire.
 - NEVER allow your body to come in contact with any broken glass or liquid from the damaged television. The LCD panel inside the TV contains

glass and a toxic liquid. If the liquid comes in contact with your mouth or eyes, or your skin is cut by broken glass, rinse the affected area thoroughly with water and contact your doctor immediately.

- ALWAYS contact a service technician to inspect the TV any time it has been damaged or dropped.

15) CAUTION:

- To reduce the risk of electric shock, do not use the polarized plug with an extension cord, receptacle, or other outlet unless the blades can be inserted completely to prevent blade exposure.
- To prevent electric shock, match wide blade of plug to wide slot; fully insert.

16) CAUTION:

- Do not let children swallow any small parts included on or with the product or play with the plastic bag. Keep the small parts and the plastic bag out of the reach of children.

17) CAUTION:

- Do not let water or other liquids come into contact with the product, as it may result in damage.

18) WARNING:

- To prevent the spread of fire, keep candles or other open flames away from this product at all times.
- Keep the product away from direct sunlight, fire or a heat source such as a heater. This may reduce the product lifetime or result in fire.

Installation, Care, and Service

Installation

Follow these recommendations and precautions and heed all warnings when installing your TV:

- 19)  **WARNING: NEVER expose batteries to excessive heat such as sunshine, fire, or the like.**
-
- 20) ALWAYS plug the product into an outlet that is located in such a manner that it can be easily unplugged in case the product requires service.
-
- 21) NEVER route the product's power cord inside a wall or similar enclosed area.
-
- 22) Never modify this equipment. Changes or modifications may void: a) the warranty, and b) the user's authority to operate this equipment under the rules of the Federal Communications Commission.

- 23)  **DANGER: RISK OF SERIOUS PERSONAL INJURY, DEATH, OR EQUIPMENT DAMAGE!**

Never place the TV on an unstable cart, stand, or table. The TV may fall, causing serious personal injury, death, or serious damage to the TV.



- 24) When selecting a location for the TV,
- NEVER allow any part of the TV to hang over the edge of the supporting furniture,
 - NEVER place the TV on tall furniture (for example, entertainment centers or bookcases) without anchoring both the furniture and the TV to a suitable support,
 - Never place cloth or other material between the TV and the supporting furniture.
 - NEVER allow children to climb on the TV
- 25) To avoid damage to this product, never place or store the TV in direct sunlight; hot, humid areas; or areas subject to excessive dust or vibration.
- 26) Always place the TV on the floor or a sturdy, level, stable surface that can support the weight of the unit. To secure the TV, use a sturdy strap from the hook(s) on the rear of the TV to a wall stud, pillar, or other immovable structure. Make sure the strap is tight, secure, and parallel to the floor.

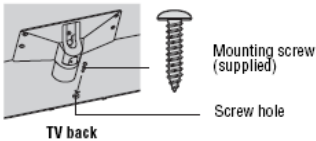

- 27) The apparatus shall not be exposed to dripping or splashing, and that no objects filled with liquids, such as vases, shall be placed on the apparatus.
- 28) Never block or cover the slots or openings in the TV cabinet back, bottom, and sides. Never place the TV:
- on a bed, sofa, rug, or similar surface;
 - too close to drapes, curtains, or walls; or
 - in a confined space such as a bookcase, built-in cabinet, or any other place with poor ventilation.
- The slots and openings are provided to protect the TV from overheating and to help maintain reliable operation of the TV. Leave a space of at least 4 (four) inches around the TV.
- 29) Always leave a space of at least 4 (four) inches around the TV. The slots and openings are provided to protect the TV from overheating and to help maintain reliable operation of the TV.
- 30) Never allow anything to rest on or roll over the power cord, and never place the TV where the power cord is subject to wear or abuse.
- 31) Never overload wall outlets and extension cords.
- 32) Always operate this equipment from a 120V AC, 60 Hz power source.
- 33) Always make sure the antenna system is properly grounded to provide adequate protection against voltage surges and built-up static charges (see Section 810 of the National Electric Code).

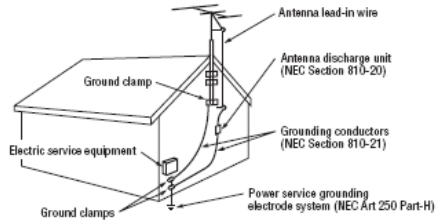

34)



DANGER: RISK OF SERIOUS PERSONAL INJURY OR DEATH!

- Use extreme care to make sure you are never in a position where your body (or any item you are in contact with, such as a ladder or screwdriver) can accidentally touch overhead power lines. Never locate the antenna near overhead power lines or other electrical circuits.
- Never attempt to install any of the following during lightning activity: a) an antenna system; or b) cables, wires, or any home theater component connected to an antenna or phone system.

Care

For better performance and safer operation of your TOSHIBA TV, follow these recommendations and precautions:

- 35) If you use the TV in a room whose temperature is 32° F (0° C) or below, the picture brightness may vary until the LCD warms up. This is not a sign of malfunction.

36)



WARNING: RISK OF SERIOUS PERSONAL INJURY OR EQUIPMENT DAMAGE!

- Never use chemicals (such as air fresheners, cleaning agents, etc.) on or near the TV pedestal. Studies indicate that plastics may weaken and crack over time from the combined effects of chemical agents and mechanical stress (such as the weight of the TV). Failure to follow these instructions could result in serious injury and/or permanent damage to TV and TV pedestal.
 - Always unplug the TV before cleaning. Gently wipe the display panel surface (the TV screen) using a dry, soft cloth (cotton, flannel, etc.). A hard cloth may damage the surface of the panel. Avoid contact with alcohol, thinner, benzene, acidic or alkaline solvent cleaners, abrasive cleaners, or chemical cloths, which may damage the surface. Never spray volatile compounds such as insecticide on the cabinet. Such products may damage or discolor the cabinet.
- 37) Never hit, press, or place anything on the back cover. These actions will damage internal parts.

38)

**WARNING:
RISK OF ELECTRIC SHOCK!**

Never spill liquids or push objects of any kind into the TV cabinet slots.

- 39) During a lightening storm, do not touch the connecting cables or product.
- 40) For added protection of your TV from lightning and power surges, always unplug the power cord and disconnect the antenna from the TV if you leave the TV unattended or unused for long periods of time.
- 41) Always unplug the TV to completely disconnect from mains power. When the TV is turned off using the on/off switch, it is not completely disconnected from power and a minute amount of current is still consumed.
- 42) During normal use, the TV may make occasional snapping or popping sounds. This is normal, especially when the unit is being turned on or off. If these sounds become frequent or continuous, unplug the power cord and contact a Toshiba Authorized Service Provider.

43)

**WARNING: RISK OF SERIOUS
PERSONAL INJURY OR
EQUIPMENT DAMAGE!**

Never strike the screen with a sharp or heavy object.

- 44) • The LCD screen of this product can be damaged by ultraviolet radiation from the sun. When selecting a location for the television, avoid locations where the screen may be exposed to direct sunlight, such as in front of a window.
- Never touch, press, or place anything on the LCD screen. These actions will damage the LCD screen. If you need to clean the LCD screen follow the instructions (in item 36) on page 4.

Service**WARNING:
RISK OF ELECTRIC SHOCK!**

Never attempt to service the TV yourself. Opening and removing the covers may expose you to dangerous voltage or other hazards. Failure to follow this WARNING may result in death or serious injury. Refer all servicing not specified in this manual to a Toshiba Authorized Service Provider.

- 45) If you have the TV serviced:
- Ask the service technician to use only replacement parts specified by the manufacturer.
 - Upon completion of service, ask the service technician to perform routine safety checks to determine that the TV is in safe operating condition.

Choosing a location for your LED TV**To Display your LCD TV on the included Pedestal Stand:**

Observe the following safety precautions:

- 1) Read and follow the pedestal assembly instructions included with the pedestal.
CAUTION: Before beginning pedestal assembly, carefully lay the front of the LCD Panel face down on a flat, cushioned surface such as a quilt or blanket. Leave the bottom of the unit protruding over the edge of the surface and assemble the pedestal as indicated below.
Note: *Extreme care should always be used when attaching the pedestal stand to avoid damage to the LCD panel.*
- 2) Place the TV on a sturdy, level surface that can support the weight of the TV.
- 3) Be sure to secure the TV to a wall, pillar, surface, or other immovable structure see item 26) page 4 for additional details.

To Display your LED TV using a Wall Bracket:

If you decide to wall mount your LED TV, always use a wall bracket Listed by an independent laboratory (such as UL, CSA, ETL) that is appropriate for the size and weight of the TV (see page 2):

- 1) **CAUTION:** Two people are required for installation.
- 2) Unplug and remove any cables and/or other component connectors from the rear of the TV.
- 3) Remove the screws of the VESA Mounting Pattern show in the table below.
CAUTION: Do not use the screws removed from the back cover to attach the wall mount bracket to the TV.
- 4) Always use the screws supplied or recommended by the wall mount manufacturer.
- 5) Follow the instructions provided with your wall bracket. Before proceeding, make sure the appropriate bracket(s) are attached to the wall and the back of the TV as described in the instructions provided with the wall bracket.
- 6) After attaching the appropriate bracket(s) to the wall and the back of the TV, remove the pedestal stand from the TV, as described below.
- 7) VESA Mounting Pattern

TV Size	Hole Pattern (HxV)	Screw Size
42L6200U	400x400 mm	M6
47L6200U	400x400 mm	M6
55L6200U	400x400 mm	M6
47L7200U	400x400 mm	M6
55L7200U	400x400 mm	M6

(unit in mm)

Removing the Pedestal Stand

- 1) Carefully lay the front of the unit face down on a flat, cushioned surface such as a quilt or blanket. Leave the stand protruding over the edge of the surface.

Note: Extreme care should always be used when removing the pedestal stand to avoid damage to the LCD panel.

- 2) Remove the screws shown in the below diagram. This will allow removal of the pedestal stand.
- 3) Once you have removed all of the screws holding the pedestal stand in place, remove the pedestal stand from the TV.

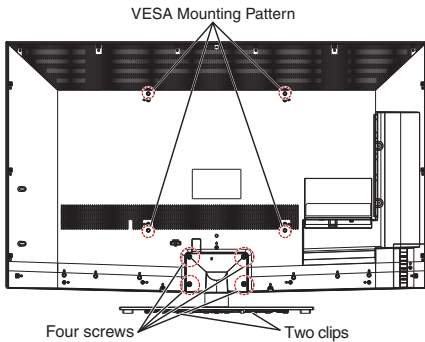

CAUTION: Always place the TV on the floor or a sturdy, level, stable surface that can support the weight of the unit. Secure the TV with the securement clip and a sturdy strap from the hooks on the rear of the TV pedestal to a wall stud, pillar, or other immovable structure. Make sure the strap is tight, secure, and parallel to the floor.

Safety Precautions for 3D glasses

About handling the 3D glasses

- Do not repair, modify, or disassemble the 3D glasses by yourself. Doing so may cause you to become indisposed while viewing 3D images.

CAUTION:

About the 3D glasses

- Carefully read instructions provided with your display and/or 3D glasses before 3D viewing.
- Do not use the 3D glasses if they are cracked, broken, or not working properly.
Continuing to use them in such a state may cause injury, eye strain, or indisposition.
- Do not drop, exert pressure on, or step on the 3D glasses. Doing so may damage the glass section which may result in injury. Exposing the 3D glasses to liquid or excessive heat may damage the function.
- Do not stand or walk while wearing 3D glasses.
You may lose your balance which could result in falls or other accidents.
- Do not wear the 3D glasses for any purpose other than viewing 3D programming.

3D glasses do not function as sunglasses.

- If your nose or temple turns red, or you feel any pain or discomfort, stop using the 3D glasses.

Such symptoms may occur when wearing 3D glasses for long periods of time.

Cautions on watching the 3D images

- Some viewers may experience a seizure or blackout when exposed to certain flashing images or lights contained in certain 3D television pictures or video games.

Anyone who has had a seizure, loss of awareness, or other symptom linked to an epileptic condition, or has a family history of epilepsy, should contact a health care professional before using the 3D function.

- Avoid using the 3D function when under the influence of alcohol.
- Some individuals may experience health-related complications when exposed to certain 3D images. Parents should monitor and/or supervise their children's use of this 3D technology. If you or your child should experience any problem, immediately stop using this 3D technology and consult a physician.
- If you are ill or feel ill, you should refrain from viewing 3D images, and consult your health care provider as may be appropriate.
- If you experience any of the following symptoms when viewing 3D video images, stop viewing and contact your health care provider:

Convulsions, Eye or muscle twitching, Loss of awareness, Altered vision, Involuntary movements, Disorientation, Eye Strain, Nausea/Vomiting, Dizziness, Headaches, Fatigue.

- If you feel eye fatigue or other discomfort from viewing 3D video images, stop viewing and take a rest until the condition improves.
- Viewing in 3D may cause dizziness and/or disorientation for some viewers.

Therefore, to avoid injury do not place your TV near open stairwells, balconies, or wires.

Also do not sit near objects that could be broken if accidentally hit.

- When viewing 3D images, always wear 3D glasses. Watching 3D images without specified 3D glasses may cause eye strain.
- Do not wear 3D glasses or watch 3D images from steep angles or while lying down.
The 3D effect is lost in these conditions and eye strain may result.
- It is recommended that the viewer's eyes and 3D glasses are level with the screen.
- If you have prescription eye glasses or contact lenses, wear the 3D glasses over them.
Watching 3D images without appropriate eyewear may cause eye strain.

- If 3D images often appear doubled or if you cannot see the images in 3D, stop viewing.

Continuous viewing may cause eye strain.

- Due to the possible impact on vision development, viewers of 3D video images should be age 6 or above.

Children and teenagers may be more susceptible to health issues associated with viewing in 3D and should be closely supervised to avoid prolonged viewing without rest.

- **Watching TV while sitting too close to the screen for an extended period of time may cause eye strain.**
- **For optimal 3D effect and to avoid eye fatigue it is important that you properly select your viewing position.**

The best viewing position is at the indicated viewing distance with your eyes at the same level as the center of the display as shown below. The center of the optimum viewing area varies from set to set. The usable viewing area is generally over the range shown in the table below (actual angle not depicted in drawing).

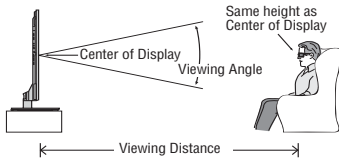

Model	Viewing angle	Viewing distance
42L6200U	Approx. 20 degrees	Over 62 inches
47L6200U	Approx. 20 degrees	Over 69 inches
55L6200U	Approx. 20 degrees	Over 81 inches
47L7200U	Approx. 26 degrees	Over 69 inches
55L7200U	Approx. 26 degrees	Over 81 inches

Important: If you see a double image, your eyes are either too high or too low in relation to the horizontal center of the screen. Adjust your position so that it is closer to the center to avoid eye fatigue and to enjoy optimum 3D effects.

FCC Caution

To assure continued compliance, follow the attached installation instructions. Any changes or modifications not expressly approved by Toshiba America Information Systems, Inc. could void the user's authority to operate this device. Service Center or an experienced radio/TV technician for help.

FCC Declaration of Conformity Compliance Statement (Part 15):

Toshiba television models 42L6200U, 47L6200U, 55L6200U, 47L7200U, and 55L7200U comply with Part 15 of the FCC Rules.

Operation is subject to the following two conditions:

- (1) This device may not cause harmful interference, and
- (2) This device must accept any interference received, including interference that may cause undesired operation.

The party responsible for compliance to these rules is:

Toshiba America Information Systems, Inc.
9740 Irvine Blvd., Irvine, CA 92618.

Ph: 800-631-3811

Note: This equipment has been tested and found to comply with the limits for a Class B digital device, pursuant to Part 15 of the FCC Rules. These limits are designed to provide reasonable protection against harmful interference in a residential installation. This equipment generates, uses, and can radiate radio frequency energy and, if not installed and used in accordance with the instructions, may cause harmful interference to radio communications. However, there is no guarantee that interference will not occur in a particular installation. If this equipment does cause harmful interference to radio or television reception, which can be determined by removing and applying power to the equipment, the user is encouraged to try to correct the interference by one of the following measures:

- Reorient or relocate the receiving antenna.
- Increase the separation between the equipment and receiver.
- Connect the equipment into an outlet on a circuit different from that to which the receiver is connected.
- Consult the dealer or an experienced radio/TV technician for help.

Caution: Changes or modifications to this equipment not expressly approved by Toshiba could void the user's authority to operate this equipment.

Wireless Radio

For product available in the USA/Canada market, only channel 1-11 can be operated. Selection of other channels is not possible. The device could automatically discontinue transmission in case of absence of information to transmit, or operational failure. Note that this is not intended to prohibit transmission of control or signaling information or the use of repetitive codes where required by the technology. If this device is going to be operated in 5.15-5.25GHz frequency range, then it is restricted to an indoor environment only.

Important: Any changes or modifications not expressly approved by the party responsible for compliance could void the user's authority to operate this equipment. This device and its antenna(s) must not be co-located or operating in conjunction with any other antenna or transmitter.

FCC Radiation Exposure Statement: This equipment complies with FCC radiation exposure limits set forth for an uncontrolled environment. This equipment should be installed and operated with minimum distance 20cm between the radiator & your body.

Canada - Industry Canada Statement

This device complies with RSS-210.

Operation is subject to the following two conditions:

(1) This device may not cause harmful interference, and
(2) This device must accept any interference received, including interference that may cause undesired operation of the device.

This device and its antenna(s) must not be co-located or operating in conjunction with any other antenna or transmitter.

Wireless Radio

For product available in the USA/Canada market, only channel 1-11 can be operated. Selection of other channels is not possible.

The device could automatically discontinue transmission in case of absence of information to transmit, or operational failure. Note that this is not intended to prohibit transmission of control or signaling information or the use of repetitive codes where required by the technology.

Important: Any changes or modifications not expressly approved by the party responsible for compliance could void the user's authority to operate this equipment.

IMPORTANT NOTE:

IC Radiation Exposure Statement: This equipment complies with IC RSS-102 radiation exposure limits set forth for an uncontrolled environment. This equipment should be installed and operated with minimum distance 20cm between the radiator & your body.

ENERGY STAR® User Information

ENERGY STAR User Information Statement: The factory default settings of this television meet ENERGY STAR® requirements. Changing Picture Settings may increase energy consumption, possibly beyond the limits required for ENERGY STAR qualification.

To ensure your television is operating at optimal energy efficiency, select [Home] mode during initial activation. To return to [Home] mode settings, select [Standard] picture mode. [Standard] mode is recommended for normal home use.



ENERGY STAR® qualified TV. Products that earn the ENERGY STAR prevent green house gas emissions by meeting strict guidelines set by the U.S. Environmental Protection Agency. ENERGY STAR and the ENERGY STAR mark are registered U.S. marks.

Important notes about your TV

The following symptoms are technical limitations of LCD Display technology and are not an indication of malfunction; therefore, Toshiba is not responsible for perceived issues resulting from these symptoms.

- 1) An afterimage (ghost) may appear on the screen if a fixed, non-moving image appears for a long period of time. The afterimage is not permanent and will disappear in a short period of time.
- 2) The LCD panel contained in this TV is manufactured using an extremely high level of precision technology; however, there may be an occasional pixel (dot of light) that does not operate properly (does not light, remains constantly lit, etc.). This is a structural property of LCD technology, is not a sign of malfunction, and is not covered under your warranty. Such pixels are not visible when the picture is viewed from a normal viewing distance.

Note: Interactive video games that involve shooting a "gun" type of joystick at an on-screen target may not work with this TV.

Trademark Information

- Cinema Series, ClearScan, ColorStream, Dynalight, GameTimer, Native Mode, Surflock, and Trivector are trademarks or registered trademarks of Toshiba America Information Systems, Inc. and/or Toshiba Corporation.
- Android is a trademark of Google Inc.



- Audyssey EQ® provides clear, accurate and natural sound right out of the box. This technology ensures you enjoy your audio experience as much as your video.



- Audyssey ABX™ technology uses sophisticated driver analysis and low frequency monitoring to extend the range and bass of small speakers. This enables the system to produce lower frequencies than would be possible with a traditional system of the same size.



- Audyssey Dynamic Volume® automatically adjusts volume to provide a consistent sound level between television programs, commercials, and between the loud and soft passages of movies.



- Audyssey Volume Extension™ doubles the volume capability in small speakers while blocking distortion, so your TV gets loud and still sounds great.



- Audyssey Premium Television™ is a suite of technologies that remove the acoustical problems caused by small speakers and drivers. Working together these technologies deliver a better translation of the audio content and make the television experience sound closer to the original.

- Manufactured under license from Audyssey Laboratories, Inc. U.S. and foreign patents pending. Audyssey EQ®, Audyssey ABX™, Audyssey Dynamic Volume®, Audyssey Volume Extension™, and Audyssey Premium Television™ are registered and licensed trademarks of Audyssey Laboratories, Inc.
- Blu-ray Disc™, Blu-ray™, and the logos are trademarks of the Blu-ray Disc Association
- CinemaNow is a registered trademark of Best Buy, Inc.
- ENERGY STAR and the ENERGY STAR mark are registered U.S. marks.



- Manufactured under license from Dolby Laboratories. Dolby and the double-D symbol are trademarks of Dolby Laboratories.



- www.espial.com

- HDMI, the HDMI Logo, and High-Definition Multimedia Interface are trademarks or registered trademarks of HDMI Licensing LLC in the United States and other countries.
- MPEG Layer-3 audio coding technology licensed from Fraunhofer IIS and Thomson.
- Netflix is a registered trademark of Netflix, Inc.



- Rovi is a trademark of Rovi Corporation and/or its subsidiaries. The Rovi Guide system is manufactured under license from Rovi Corporation and/or its subsidiaries.

- VUDU, Vudu Apps, and Vudu Movies are licensed and registered trademarks of VUDU, Inc
- YouTube is a registered trademark of Google, Inc.



- Designed with UEI Technology™. Under License from Universal Electronics inc. Portions © UEI 2000-2012.

- THIS PRODUCT IS LICENSED UNDER THE AVC PATENT PORTFOLIO LICENSE FOR THE PERSONAL AND NON-COMMERCIAL USE OF A CONSUMER TO (i) ENCODE VIDEO IN COMPLIANCE WITH THE AVC STANDARD ("AVC VIDEO") AND/OR (ii) DECODE AVC VIDEO THAT WAS ENCODED BY A CONSUMER ENGAGED IN A PERSONAL AND NON-COMMERCIAL ACTIVITY AND/OR WAS OBTAINED FROM A VIDEO PROVIDER LICENSED TO PROVIDE AVC VIDEO. NO LICENSE IS GRANTED OR SHALL BE IMPLIED FOR ANY OTHER USE. ADDITIONAL INFORMATION MAY BE OBTAINED FROM MPEG LA, LLC. SEE HTTP://WWW.MPEGLA.COM
- THIS PRODUCT IS LICENSED UNDER THE VC-1 PATENT PORTFOLIO LICENSE FOR THE PERSONAL AND NON-COMMERCIAL USE OF A CONSUMER TO (i) ENCODE VIDEO IN COMPLIANCE WITH THE VC-1 STANDARD ("VC-1 VIDEO") AND/OR (ii) DECODE VC-1 VIDEO THAT WAS ENCODED BY A CONSUMER ENGAGED IN A PERSONAL AND NON-COMMERCIAL ACTIVITY AND/OR WAS OBTAINED FROM A VIDEO PROVIDER LICENSED TO PROVIDE VC-1 VIDEO. NO LICENSE IS GRANTED OR SHALL BE IMPLIED FOR ANY OTHER USE. ADDITIONAL INFORMATION MAY BE OBTAINED FROM MPEG LA, LLC. SEE HTTP://WWW.MPEGLA.COM
- THIS PRODUCT IS LICENSED UNDER THE MPEG-4 VISUAL PATENT PORTFOLIO LICENSE FOR THE PERSONAL AND NON-COMMERCIAL USE OF A CONSUMER FOR (i) ENCODING VIDEO IN COMPLIANCE WITH THE MPEG-4 VISUAL STANDARD ("MPEG-4 VIDEO") AND/OR (ii) DECODING MPEG-4 VIDEO THAT WAS ENCODED BY A CONSUMER ENGAGED IN A PERSONAL AND NON-COMMERCIAL ACTIVITY AND/OR WAS OBTAINED FROM A VIDEO PROVIDER LICENSED BY MPEG LA TO PROVIDE MPEG-4 VIDEO. NO LICENSE IS GRANTED OR SHALL BE IMPLIED FOR ANY OTHER USE. ADDITIONAL INFORMATION INCLUDING THAT RELATING TO PROMOTIONAL, INTERNAL AND COMMERCIAL USES AND LICENSING MAY BE OBTAINED FROM MPEG LA, LLC. SEE HTTP://WWW.MPEGLA.COM

Copyright

This guide is copyrighted by Toshiba America Information Systems, Inc. with all rights reserved. Under the copyright laws, this guide cannot be reproduced in any form without the prior written permission of Toshiba. No patent liability is assumed, however, with respect to the use of the information contained herein.

©2012 by Toshiba America Information Systems, Inc. All rights reserved.

Notice

The information contained in this manual, including but not limited to any product specifications, is subject to change without notice.

TOSHIBA CORPORATION AND TOSHIBA AMERICA INFORMATION SYSTEMS, INC. (TOSHIBA) PROVIDES NO WARRANTY WITH REGARD TO THIS MANUAL OR ANY OTHER INFORMATION CONTAINED HEREIN AND HEREBY EXPRESSLY DISCLAIMS ANY IMPLIED WARRANTIES OF MERCHANTABILITY OR FITNESS FOR ANY PARTICULAR PURPOSE WITH REGARD TO ANY OF THE FOREGOING. TOSHIBA ASSUMES NO LIABILITY FOR ANY DAMAGES INCURRED DIRECTLY OR INDIRECTLY FROM ANY TECHNICAL OR TYPOGRAPHICAL ERRORS OR OMISSIONS CONTAINED HEREIN OR FOR DISCREPANCIES BETWEEN THE PRODUCT AND THE MANUAL. IN NO EVENT SHALL TOSHIBA BE LIABLE FOR ANY INCIDENTAL, CONSEQUENTIAL, SPECIAL, OR EXEMPLARY DAMAGES, WHETHER BASED ON TORT, CONTRACT OR OTHERWISE, ARISING OUT OF OR IN CONNECTION WITH THIS MANUAL OR ANY OTHER INFORMATION CONTAINED HEREIN OR THE USE THEREOF.

Contents

Chapter 1: Introduction.....	20
Features	21
Overview of installation, setup, and use.....	22
TV front and side panel controls and connections ..	23
Front panel.....	23
Left side	23
TV back panel controls and connections.....	24
Back panel controls.....	25
Back panel connections	25
Chapter 2: Connecting Your TV	27
Overview of cable types	27
Coaxial cable (F-type)	27
Standard A/V cables (red/white/yellow)	27
Component video cables (red/green/blue)	28
HDMI® cable (with HDMI Logo).....	28
Dual-wand IR blaster cable	29
Optical audio cable.....	29
Analog RGB (15-pin) computer cable	29
3.5mm Stereo to RCA Y-cable	29

LAN cable.....	30
About the connection illustrations	30
Connecting an antenna, satellite receiver, and cable TV box	30
Connecting DVD to ColorStream® or VCR to composite video.....	31
Connecting remote IR devices	33
Using the IR blaster OUT terminal	33
Connecting a digital audio system	35
Connecting an HDMI® or DVI device to the HDMI® input	36
Using the TV remote and HDMI® CEC Control to control other devices	38
Connecting an HDMI® audio system.....	39
Connecting a computer	39
Connecting a computer to the TV's PC IN terminal:.....	40
Connect a computer to the TV's HDMI® terminal.....	41
Connecting to a home network	42
Connecting the TV directly to a computer without an Internet connection	43
Connecting the TV to a home network without an Internet connection	43
Connecting the TV to a home network with an Internet connection - wired	44
Connecting the TV to a home network with an Internet connection - wireless.....	44
Chapter 3: Using the Remote Control.....	46
Controlling other devices	46
Installing batteries	46
Remote control effective range	48
Learning about the remote control.....	49
Chapter 4: Initial Setup and Menu	51

Initial setup	51
Performing the initial setup.....	52
IR Blaster Setup	55
Network Setup	58
MediaGuide Setup.....	59
Navigating the menu system.....	61
Main menu layout	62
Quick Menu.....	63
Chapter 5: Setting up your TV	64
How to navigate the menu	64
Changing initial settings.....	64
Individual settings.....	65
Storing channels in memory (optional).....	66
Skipping channels.....	68
Skipping video inputs	68
Labeling analog TV channels	69
Labeling video inputs	70
Configuring shared inputs.....	70
Setting the Auto Input feature	70
Chapter 6: Basic features.....	72
Viewing 3D images	72
Using 3D functions	74
Switching display mode or selecting 3D format	76
The 3D button operation	76
Switching to 3D mode	77
Selecting 3D format from the Quick menu in 3D mode	78
Switching to 2D mode	79
Selecting 2D format from the Quick menu in 2D mode	79
Switching to Native mode	80
Setting the auto start mode.....	81
Setting the 3D PIN code.....	81

Enter a new PIN code.....	81
Change or delete your PIN code.....	82
Forgotten PIN codes	82
Setting the 3D start message.....	82
Setting the 3D Lock	83
Setting the 3D Timer Lock	83
Setting the Enable 3D Timer	83
Displaying 3D Important Information.....	84
Adjusting 2D to 3D depth.....	84
Switching left and right images.....	85
Tuning Channels	85
Tuning to the next programmed channel	85
Tuning to a specific channel (programmed or unprogrammed).....	85
Using Channel Return	85
Using SurfLock™	85
Selecting the video input to view	86
Using closed captions	87
Analog CC mode	87
Digital CC settings.....	89
Setting the PIN code	90
Entering a new PIN code.....	91
Changing or deleting your PIN code	91
Forgotten PIN code	91
Using parental controls.....	91
Blocking TV programs and movies by rating (V-Chip)	91
Downloading an additional rating system	92
Displaying ratings	95
Unlocking programs	95
Locking specific channels	95
Locking video inputs.....	96
Setting a time limit for games.....	96
Locking the control panel.....	97
Using HDMI® CEC Control	97
Controlling HDMI® CEC playback devices	98

HDMI® CEC Control input source selection.....	100
Adjusting the amplifier's audio.....	100
Other HDMI® CEC Control functions	101
Using the HDMI® RGB Range feature	101
Viewing the HDMI® signal information	102
Using your computer with the TV	102
Adjusting the image	102
Setting the computer audio.....	103
Setting the timer to turn on the TV.....	104
Setting the sleep timer	105
Setting No Signal Power Down	106
Displaying TV status information	106
Viewing support information.....	107
Resetting to Factory Defaults	107
Power failure.....	108
Chapter 7: Picture and Sound Controls.....	109
Selecting the picture size	109
Native.....	110
4:3	111
Full	111
TheaterWide 1	112
TheaterWide 2.....	112
TheaterWide 3.....	112
Normal	113
Dot by Dot.....	113
Scrolling the picture.....	113
Using the Auto Aspect feature.....	114
Using the 4:3 Stretch	114
Adjusting the picture.....	115
Selecting the picture mode	115
Adjusting the picture quality	115
Using the advanced picture settings features.....	117
Edge Enhancer	117
Dynamic Contrast	117
DynaLight®	118

Static Gamma	118
ClearScan®	118
Cinema Mode	119
MPEG NR	119
DNR	119
Auto Brightness Sensor	120
Backlight Adjustment Pro	120
ColorMaster™	121
Base Color Adjustment	121
Color temperature	122
Resetting to the factory default	122
Setting the expert picture settings	122
Test Pattern	122
RGB Filter	123
White Balance	123
Locking the picture settings	124
Adjusting the audio	125
Muting the sound	125
Selecting stereo/SAP broadcasts	125
Adjusting the audio balance	125
Adjusting the range	126
Selecting the optical audio output format	126
Using the Dolby® Digital Dynamic Range Control feature	126
Audyssey Premium Television™	127
Using Audyssey EQ® for Wall Mounted or Table-top TVs	127
Using Audyssey Dynamic Volume ®	127
Audyssey ABX™	128
Using the surround sound feature	128
Chapter 8: Advanced features	129
Using your home network	129
When using a Wireless network connection: ..	130
Setting up the Network	131
Wireless Setup	131

Advanced Network Setup	136
DNS Setup	137
Network Connection Test	139
Using the software keyboard	139
Enter text using the keypad	139
Enter text using the full keyboard	139
Performing a Software Upgrade	140
Viewing the Software Licenses	141
Using the SmartTV features	142
eMANUAL	142
ePORTAL page	142
ePORTAL SearchAll	142
ePORTAL Apps	144
Netflix®	144
VUDU™	145
YouTube™	146
CinemaNow®	147
ePORTAL Internet	147
ePORTAL Messages	151
ePORTAL Events	151
ePORTAL Favorite Sites	152
Edit ePORTAL Favorites	152
ePORTAL Preferences	153
MediaGuide	153
ePORTAL MediaShare (Videos, Music, and Photos)	157
MediaShare (Media Player) specifications	157
Basic operation	158
Viewing movie files	160
Playing music files	162
Viewing photo files	164
Search	167
Network Device Setup	167
External Control Setup	167
Setting up the Media Renderer feature	168
Apps Control Profile	171

Toshiba A/V Remote App	171
Initial setup	172
Controlling devices	173
Mouse control	175
Touchpad control	176
Combo	176
Toshiba MediaGuide app	177
Toshiba Send & Play App	178
Launching the app	179
Text input	180
Chapter 9: Troubleshooting	181
General troubleshooting	181
Picture problems	182
Sound problems	184
Remote control problems	184
Channel tuning problems	184
Closed caption problems	185
Rating blocking (V-Chip) problems	185
HDMI® CEC Control operation	185
HDMI® problems	186
Network problems	186
Wireless network problems	188
MediaShare (Media Player) problems	188
Light Indicator	189
Power On/Standby light	189
If the problem persists after trying the solutions ..	190
Appendix A: Specifications	191
Television system	191
Channel coverage	191
Power source	192
Power consumption	192
Audio power	192
Speaker type	192
Video/audio terminals	193

Video/audio input.....	193
ColorStream® (component video) HD input...	193
HDMI® input.....	193
Digital audio output.....	193
PC input.....	193
Wireless connection.....	193
Ethernet.....	194
USB.....	194
Dimensions (include foot stand).....	194
Mass (weight).....	194
Operating conditions.....	194
Supplied accessories.....	195
Acceptable signal formats for PC IN, HDMI®, and 3D.....	195
PC IN signal formats.....	195
HDMI® signal formats.....	196
3D Signal formats*.....	198
Operating the TV with combination buttons.....	199
Index.....	201

Chapter 1

Introduction

Safety icons

This manual contains safety instructions that must be observed to avoid potential hazards that could result in personal injuries, damage to your equipment, or loss of data. These safety cautions have been classified according to the seriousness of the risk, and icons highlight these instructions as follows:

▲ DANGER

Indicates an imminently hazardous situation which, if not avoided, will result in death or serious injury.

▲ WARNING

Indicates a potentially hazardous situation which, if not avoided, could result in death or serious injury.

▲ CAUTION

Indicates a potentially hazardous situation which, if not avoided, may result in minor or moderate injury.

CAUTION

Indicates a potentially hazardous situation which, if not avoided, may result in property damage.

NOTE

Provides important information.

Features

- ❖ **Integrated digital tuning (8VSB ATSC and QAM)**—Eliminates the need for a separate digital converter set-top box (in most cases).
- ❖ **1920 x 1080 output resolution.**
- ❖ **Four HDMI®**—Digital, High-Definition Multimedia Interfaces with 1080p input support
- ❖ **HDMI® capabilities**
 - ARC (Audio Return Channel)**—Enables the audio signal of the TV to be sent to an AV amplifier via an HDMI® cable.
 - RGB Range**—Adjusts RGB full range signal automatically.
- ❖ **HDMI® CEC Control**—Allows control of external devices from the TV remote via HDMI® connection
- ❖ **ColorStream® HD**—High-resolution component video input.
- ❖ **Digital Audio Out**—Optical audio connection with Dolby® Digital optical output format, see [“Connecting a digital audio system” on page 34.](#)
- ❖ **PC IN (Analog RGB)**—Computer terminal, see [“Connecting a computer” on page 39.](#)
- ❖ **IR Blaster Out**— Controls infrared remote controlled devices from the TV.
- ❖ **Built-in WLAN**—Allows the television to access your home wireless network without an external Dual Band WLAN Adapter.
- ❖ **ColorMaster™**—Allows you to adjust the TV’s standard colors, see [“ColorMaster™” on page 121.](#)
- ❖ **ClearScan®** —Provides picture clarity for fast motion video using new Backlight Scanning technology.
- ❖ **AutoView®**—Allows you to automatically adjust picture settings based on ambient light conditions and input signal content, see [“ENERGY STAR® User Information” on page 8.](#)
- ❖ **Dynamic Volume (Audyssey Dynamic Volume®)**—Eliminates inconsistent TV volume when changing channels or viewing commercials, see [“Audyssey Premium Television™” on page 127.](#)
- ❖ **MediaShare (Media Player)**—Allows you to view photo files and play music or movie files, see [“ePORTAL MediaShare \(Videos, Music, and Photos\)” on page 157.](#)

- ❖ **3D capability**—Allows you to view and experience 3D content on the television while using special glasses.
- ❖ **ENERGY STAR® qualified**



Overview of installation, setup, and use

Follow these steps to set up your TV and begin using its many exciting features.

- 1 Carefully read the important safety, installation, care, and service information. Keep this manual for future reference.
- 2 To choose a location for the TV:
 - ❖ Read [“Important notes about your TV”](#) on page 8.
 - ❖ Place the TV on the floor or a sturdy, level, stable surface that can support the weight of the unit. Secure the TV to a wall, pillar, or other immovable structure, see [24](#)) on page 4.
 - ❖ Place the TV in a location where light does not reflect on the screen.
 - ❖ Place the TV far enough from walls and other objects to allow proper ventilation. Inadequate ventilation may cause overheating, which will damage the TV. THIS TYPE OF DAMAGE IS NOT COVERED UNDER THE TOSHIBA WARRANTY.
- 3 Do not plug in any power cords until after you have connected all cables and devices to your TV.
- 4 Before connecting cables or devices to the TV, learn the functions of the TV’s connections and controls, see [“Overview of cable types”](#) on page 27.
- 5 Connect your other electronic device(s) to the TV, see [“Connecting Your TV”](#) on page 27.
- 6 Install the batteries in the remote control, see [“Installing batteries”](#) on page 46
- 7 See [“Using the Remote Control”](#) on page 46 for an overview of the buttons on the remote control.
- 8 After connecting all cables and devices, plug in the power cords for your TV and other devices. Then press the POWER button on the TV control panel or remote control to turn on the TV. If the TV stops responding to the buttons on the remote control or TV control panel and you cannot turn the TV off or

TV front and side panel controls and connections

on, unplug the power cords for a few seconds and then plug them in and try again.

- 9 See “[Navigating the menu system](#)” on page 61 for a quick overview of navigating the TV’s menu system.
- 10 Program channels into the TV’s channel memory, see “[Auto Tuning](#)” on page 66.
- 11 For details on using the TV’s features, see chapters 6, 7, and 8.
- 12 For help, refer to “[Troubleshooting](#)” on page 181.
- 13 For technical specifications, see “[Specifications](#)” on page 191.

TV front and side panel controls and connections

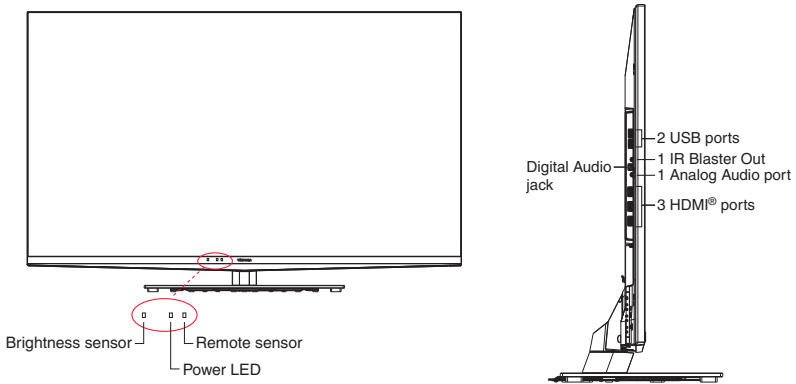

(Sample Illustration) L6200U/L7200U Series front and side panel controls and connections

Front panel

- 1 **Power On/Standby LED**—Power indicator light, (glows green when the TV power is On).
- 2 **Brightness Sensor**—This sensor detects the ambient light conditions to optimize the backlighting levels, see “[Auto Brightness Sensor](#)” on page 120.
- 3 **Remote Sensor**—Point the remote control toward this remote sensor, see “[Remote control effective range](#)” on page 48.

Left side

- 4 **2 USB Ports**—Used to access video, music, or photo files with USB device.

- 5 **IR Blaster OUT**—Used to connect and control infrared remote-controlled devices.
- 6 **Digital Audio Jack**—Optical audio output in Dolby® Digital or PCM (pulse-code modulation) format for connecting an external Dolby® Digital decoder, amplifier, A/V receiver, or home theater system with optical audio input.
- 7 **Analog Audio Port**—Analog audio outputs for connecting an audio amplifier.
- 8 **3 HDMI Ports**—High-Definition Multimedia Interface input receives digital audio and uncompressed digital video from an HDMI® device or uncompressed digital video from a DVI device. HDMI® connection is necessary to receive 1080p signals.

TV back panel controls and connections

For explanations of cable types and connections, see “[Connecting Your TV](#)” on page 27.

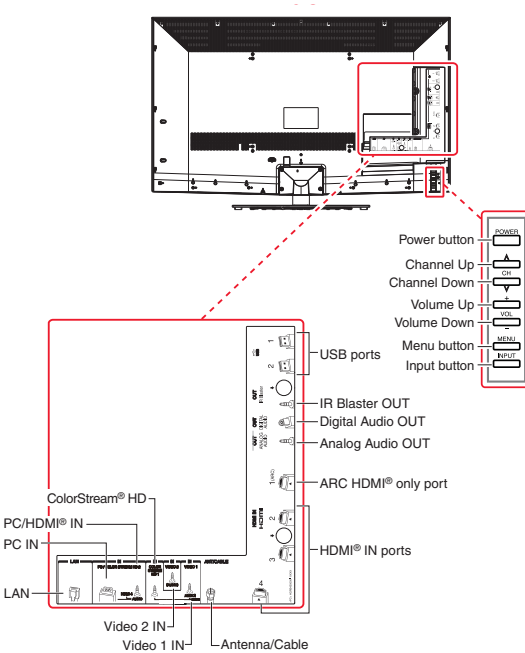

(Sample Illustration) L6200U/L7200U Series back panel controls and connections

Back panel controls

- 1 POWER**—Turns the TV **On** and **Off**.
- 2 VOL +/-** —Adjusts the volume level. When an onscreen menu appears, these keys function as (◀/▶) menu navigation buttons.
- 3 CH Up/Down arrow buttons**—Changes the channel. When an onscreen menu appears, these buttons function as (▲/▼) menu navigation buttons.
- 4 MENU**—Accesses the menu. When an onscreen menu appears, the **MENU** button on the TV's control panel functions as the **BACK** button.
- 5 INPUT**—Changes the source you are viewing. When an onscreen menu appears, the **INPUT** button on the TV's control panel functions as the **OK** button.

Back panel connections

- 6 LAN IN**—Connects the TV to your home network.
- 7 PC/ColorStream HD2 IN**—For use when connecting a personal computer.
- 8 PC/HDMI-4 (Audio) IN**—PC audio input terminals are shared with HDMI®-4 analog audio input terminals, and their use can be configured in the Configuring shared inputs menu, see “Configuring shared inputs” on page 70.
- 9 ColorStream® HD1 IN**—These include standard A/V connections, see “Connecting DVD to ColorStream® or VCR to composite video” on page 31.
- 10 Video 2 IN**—Video input.
- 11 Video 1 IN**—Video input.
- 12 ANT/CABLE**—Antenna input that supports analog (NTSC) and digital (ATSC) off-air antenna signals and analog and digital Cable TV (QAM) signals.
- 13 HDMI® IN**—High-Definition Multimedia Interface input receives digital audio and uncompressed digital video from an HDMI® device or uncompressed digital video from a DVI device. HDMI® connection is necessary to receive 1080p signals.
- 14 ARC HDMI® only port**—Audio Return Channel (ARC) enables the audio signal of the TV to be sent to an AV amplifier via the HDMI cable.

- 15 Analog Audio OUT**—Analog audio outputs for connecting an audio amplifier.
 - 16 Digital Audio OUT**—Optical audio output in Dolby® Digital or PCM (pulse-code modulation) format for connecting an external Dolby® Digital decoder, amplifier, A/V receiver, or home theater system with optical audio input.
 - 17 IR Blaster OUT**—Used to connect and control infrared remote controlled devices.
 - 18 2 USB ports**—To access video, music, or photo files with USB device.
-

NOTE

Component/Standard (composite) video cables carry only video information; separate audio cables are required.

Chapter 2

Connecting Your TV

Overview of cable types

Before purchasing cables, know the connector types your devices require. You can purchase cables from most stores that sell audio/video devices.

Coaxial cable (F-type)



(Sample Illustration) Coaxial cable

Coaxial (F-type) cable connects your antenna, cable TV service, and/or cable converter box to the ANT/CABLE input on your TV.

Standard A/V cables (red/white/yellow)

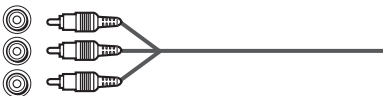

(Sample Illustration) Standard AV cables

Standard A/V cables (composite video) usually come in sets of three, and connects to video devices with analog audio and composite video output. These cables (and the related inputs on your TV) are typically color-coded according to use: yellow for

video, red for stereo right audio, and white for stereo left (or mono) audio.

Component video cables (red/green/blue)

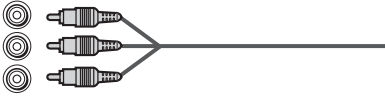

(Sample Illustration) Component video cables

Component video cables come in sets of three and are for use with video devices with component video output. (ColorStream[®] is Toshiba's brand of component video.) These cables are typically color-coded red, green, and blue. Separate audio cables are required for a complete connection.

NOTE

Component video cables provide better picture quality than composite video cables.

HDMI[®] cable (with HDMI Logo)



(Sample Illustration) HDMI[®] cable

HDMI[®] (High-Definition Multimedia Interface) cable connects to devices that have an HDMI[®] output. An HDMI[®] cable delivers digital audio and video in its native format. Separate audio cables are not required, see [“Connect a computer to the TV’s HDMI[®] terminal” on page 41.](#)

NOTE

HDMI[®] cables provide the best audio and picture quality.

Dual-wand IR blaster cable

Connect the dual-wand IR blaster cable to the IR blaster terminal to control infrared remote controlled devices from the TV.

Optical audio cable



(Sample Illustration) Optical audio cable

Optical audio cable connects receivers with Dolby® Digital or PCM (pulse-code modulation) optical audio input to the TV's **Digital Audio Out** terminal, see [“Connecting a digital audio system” on page 34.](#)

Analog RGB (15-pin) computer cable

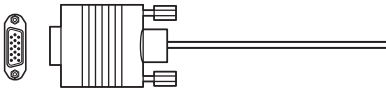

(Sample Illustration) Analog RGB (15-pin) computer cable

Analog RGB (15-pin) computer cable connects a computer to the TV's **PC IN** terminal, see [“Connecting a computer to the TV's PC IN terminal:” on page 40.](#)

NOTE Separate audio cables are required.

3.5mm Stereo to RCA Y-cable



(Sample Illustration) 3.5mm Stereo to RCA Y-cable

3.5mm Stereo to RCA Y-cable connects an audio signal from DVI device to TV.

LAN cable



(Sample Illustration) LAN cable

Standard LAN cable connects the TV to your home network, see [“Connecting the TV to a home network with an Internet connection - wired” on page 44.](#)

Crossover LAN cable connects the TV directly to a computer, see “Connecting the TV directly to a computer without an Internet connection” on page 43.

About the connection illustrations

You can connect different types and brands of devices to your TV in several different configurations. The connection illustrations in this manual are representative of typical device connections only. The input/output terminals on your devices may differ from those illustrated herein. For details on connecting and using your specific devices, refer to each device’s owner’s manual.

Connecting an antenna, satellite receiver, and cable TV box

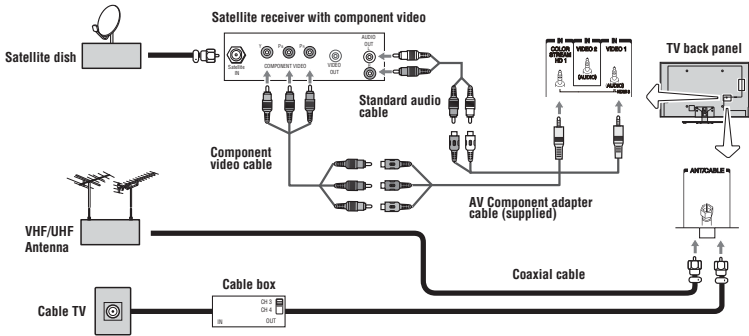

(Sample Illustration) L6200U/L7200U Series—Connecting to an antenna, satellite receiver, and cable TV box

Items needed:

- ❖ Coaxial cables
- ❖ Standard AV cables
- ❖ Component video cables (red/green/blue)

NOTE

When you use a cable box, you may not be able to use the remote control to program or access certain features on the TV.

To view the antenna or cable signal:

Select **ANT/CABLE** video input source on the TV.*

To view basic and premium cable channels:

Select the **ANT/CABLE** video input source on the TV.* Tune the TV to channel 3 or 4 (whichever channel the cable box output is set to). Use the cable box controls to change channels.

Connecting DVD to ColorStream® or VCR to composite video

To view the VCR or camcorder video:

Turn On the VCR or camcorder video. Select **VIDEO** input source on the TV.*

*To select the video input source, press the **INPUT** button on the remote control, see “Selecting the video input to view” on page 86.

NOTE

The unauthorized recording, use, distribution, or revision of television programs, videotapes, DVDs, and other materials is prohibited under the Copyright Laws of the United States and other countries, and may subject you to civil and criminal liability.

Connecting DVD to ColorStream® or VCR to composite video

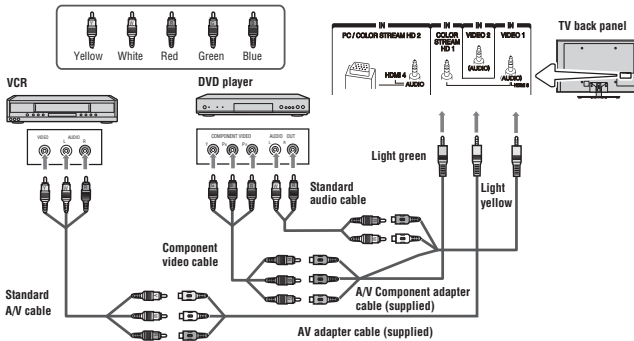

(Sample Illustration) L6200U/L7200U Series—Connecting a DVD with ColorStream® or a VCR with composite video

Items needed:

- ❖ Coaxial cables
- ❖ Standard AV cables
- ❖ Standard audio cables
- ❖ Composite or component video cables
 - ❖ You can connect the component video cables (plus audio cables) from the DVD player or satellite receiver to the **COLOR STREAM HD** terminal in the TV. The **COLOR STREAM HD** terminal can be used to display Progressive (480p, 720p) and Interlaced (480i, 1080i) scan systems. Note that 1080p is not supported. Check the User's Guide of the DVD player in order to determine the best output signal available.

-
- ❖ If your DVD player or satellite receiver does not have component video, connect a standard A/V cable to the **AUDIO/VIDEO** terminal. If your DVD player has HDMI® video, see [“Connecting an HDMI® or DVI device to the HDMI® input” on page 35.](#)
-

NOTE When you use ColorStream® HD or Video, please switch to the appropriate AV mode.

To view antenna or Cable channels:

Select the **ANT/CABLE** video input source on the TV.*

To view the DVD player:

Turn ON the DVD player. Select the **ColorStream® HD video** input source on the TV.*

To view satellite programs using the component video connections:

Turn ON the satellite receiver. Select the **ColorStream® HD video** input source on the TV.*

To view the VCR or view and record antenna channels:

Turn ON the VCR. Tune the VCR to the channel you want to watch. Select the **VIDEO** video input source on the TV.*

To record a TV program while watching a DVD:

Turn ON the VCR. Tune the VCR to the channel to record. Select the **ColorStream® HD video** input source on the TV* to view the DVD.

*To select the video input source, press the **INPUT** button on the remote control, see [“Selecting the video input to view” on page 86.](#)

NOTE The unauthorized recording, use, distribution, or revision of television programs, videotapes, DVDs, and other materials is prohibited under the Copyright Laws of the United States and other countries, and may subject you to civil and criminal liability.

Connecting remote IR devices

Using the IR blaster OUT terminal

You can use the TV's IR OUT terminal to remotely operate many infrared remote-controlled devices enclosed in an entertainment center or similar cabinet.

Items needed:

- ❖ Dual-wand IR blaster cable (see “Dual-wand IR blaster cable” on page 29)
- ❖ Other cables as required to connect the device(s) to the TV (see “Overview of cable types” on page 27)

See the remote IR blaster setup section.

To connect the IR blaster cable:

- 1 Locate the infrared sensor on the front of your device. This sensor is marked on some devices. If you are having issues locating the device's infrared sensor, see “If you cannot locate the device's infrared sensor:” on page 34.
- 2 Align one of the IR blaster cable's wands approximately 1 inch away from the infrared sensor on the front of the device and attach it using double-sided mounting tape. If you have a second device, attach the second wand in a similar manner.

NOTE

If you do not have a second device, coil the second wand with a rubber band and leave it behind the TV.

- 3 Plug the IR blaster cable's plug into the TV's IR Blaster Out terminal.

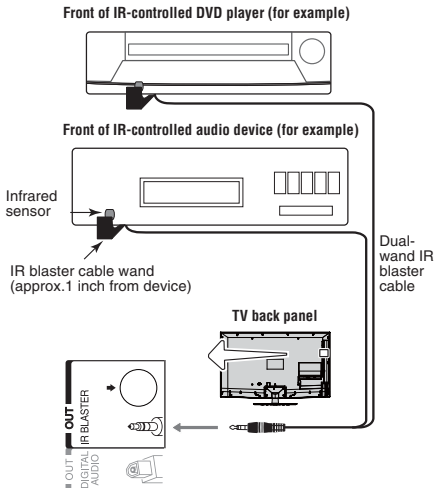

(Sample Illustration) L6200U/L7200U Series—Using the IR blaster OUT terminal

To control the device(s):

Point the TV remote control toward the front of the TV and press the button for the desired function. The signal passes from the remote control through the TV to the device via the IR Blaster cable. For more information, see “[IR Blaster Setup](#)” on page 55.

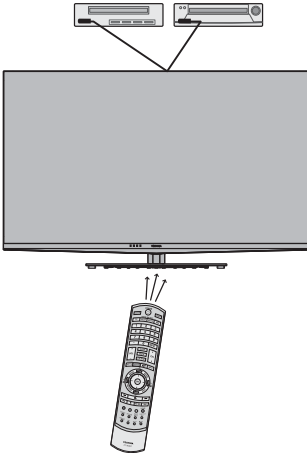

(Sample Illustration) Controlling the device(s) - remote control

NOTE The IR pass-through feature does not support all IR controlled devices. Satisfactory quality may not be attainable with certain devices.

If you cannot locate the device’s infrared sensor:

- 1** Turn off the device.
- 2** Starting at the device’s lower-left corner, place the end of the device’s remote control (with the infrared emitter) so it touches the front of the device. Press the **POWER** button. (Do not use the TV’s remote control for this step.)
- 3** If the device turns on, the sensor is located where the remote control touched the device.
- 4** If the device does not turn on, move the remote control slightly to the right and press the **POWER** button again.
- 5** Repeat the previous steps if necessary.

Connecting a digital audio system

The TV’s Digital Audio Out terminal outputs a Dolby® Digital or 2-channel down-mixed PCM (pulse-code modulation) signal for

Connecting an HDMI® or DVI device to the HDMI® input

use with an external Dolby Digital decoder or other external audio system with optical audio input.

You will need an Optical audio cable (Use an optical audio cable that has the larger “TosLink” connector and not the smaller “mini-optical” connector.)

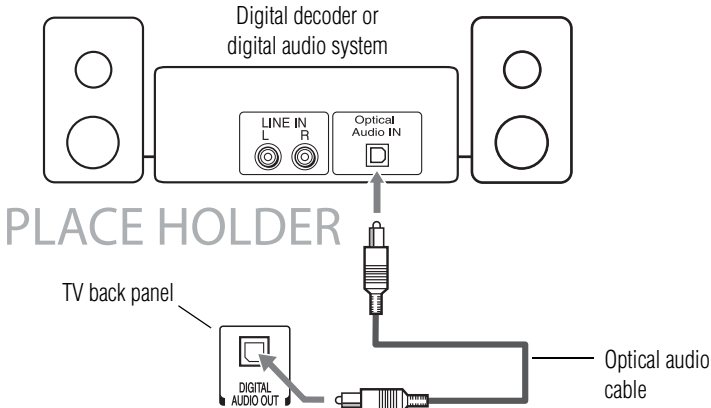

(Sample Illustration) L6200U/L7200U Series—Connecting a digital audio system

Before controlling the audio, see “[Selecting the optical audio output format](#)” on page 126.

NOTE

Some audio systems may not be compatible with Dolby Digital bitstream signals. Older audio systems that are not compatible with standard optical out signals may not work properly, creating a high noise level that may damage speakers or headphones. THIS DAMAGE IS NOT COVERED BY YOUR WARRANTY.

The DIGITAL AUDIO OUT terminal may not output some digital audio sources because of copy restrictions.

The Dolby Digital format is available in the following situations:

- ❖ When tuned to a digital RF channel
- ❖ When an HDMI input is used
- ❖ When DLNA Certified products are used

Connecting an HDMI® or DVI device to the HDMI® input

The HDMI® input on your TV receives digital audio and uncompressed digital video from an HDMI® source device, or

uncompressed digital video from a DVI (Digital Visual Interface) source device.

This input is designed to accept HDCP (High-Bandwidth Digital-Content Protection) program material in digital form from EIA/CEA-861-D-compliant[1] consumer electronic devices (such as a set-top box or DVD player with HDMI® or DVI output).

The HDMI® input can accept and display VGA, SVGA, XGA, WXGA, SXGA, 480i (60Hz), 480p (60Hz), 720p (60Hz), 1080i (60Hz), and 1080p (24Hz/60Hz) signal formats. For detailed signal specifications, see “HDMI® signal formats” on page 196.

The supported Audio formats are Linear PCM and Dolby® Digital, sampling rate 32/44.1/ 48 kHz.

NOTE To connect a PC to the HDMI® input, see “Connect a computer to the TV’s HDMI® terminal” on page 41.

To connect an HDMI® device, you will need one HDMI® cable (type A connector) per HDMI® device:

- ❖ For proper operation, it is recommended that you use an HDMI® cable with the HDMI® Logo (**HDMI**).
- ❖ To display an 1080ip/60Hz signal format, you will need a High Speed HDMI® cable. A conventional HDMI®/DVI cable may not work properly.
- ❖ HDMI® cables transfer both video and audio. Separate analog audio cables are not required (see illustration).

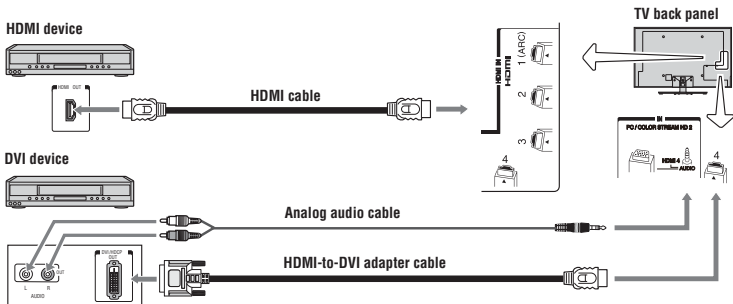

(Sample Illustration) L6200U/L7200U Series—Connecting an HDMI® or DVI device to the HDMI® Input

To view the HDMI® device video:

Select **HDMI 1**, **HDMI 2**, **HDMI 3** or **HDMI 4** video input source on the TV. (Press the **INPUT** button on the remote control. For

more information, see “Selecting the video input to view” on page 86.

To connect a DVI device, you will need:

- ❖ HDMI® to DVI adapter cable
For proper operation, the length of an HDMI® to DVI adapter cable should not exceed 9.8 ft (3m). The recommended length is 6.6 ft (2m).
- ❖ 3.5mm Stereo to RCA Y-cable
An HDMI® to DVI adapter cable transfers video only. Separate analog audio cables are required (see illustration).

NOTE

To ensure that the HDMI® or DVI device is reset properly:

- ❖ When turning on your electronic components, turn on the TV first, and then the HDMI® or DVI device.
- ❖ When turning off your electronic components, turn off the HDMI® or DVI device first, and then the TV.

NOTE

[1] EIA/CEA-861-D compliance covers the transmission of uncompressed digital video with high-bandwidth digital content protection, which is being standardized for reception of high-definition video signals. Because this is an evolving technology, it is possible that some devices may not operate properly with the TV.

Using the TV remote and HDMI® CEC Control to control other devices

To control the basic functions of connected audio/video devices using the TV’s remote control, connect an HDMI® CEC compatible audio receiver or playback device. The HDMI® CEC Control feature uses CEC technology as regulated by the HDMI® standard.

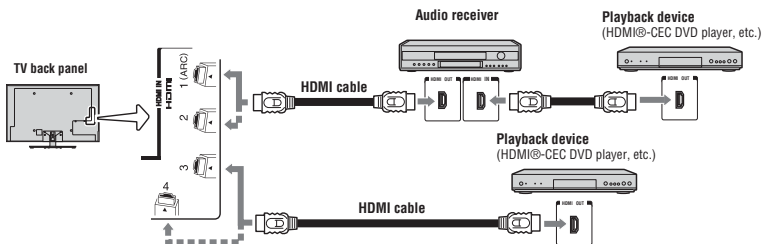

(Sample Illustration) L6200U/L7200U Series—Connecting an HDMI® CEC compatible audio receiver and playback device

To connect an audio receiver and playback devices, you will need HDMI® cables, see “HDMI® cable (with HDMI Logo)” on page 28.

- NOTE If several devices are connected, HDMI® CEC Control feature may not operate properly, see “HDMI® CEC Control input source selection” on page 100.
- For proper operation, it is recommended that you use HDMI® cables with the HDMI® Logo (**HDMI**).
-

Before controlling the devices:

- ❖ For an explanation of setup and operations, see “Other HDMI® CEC Control functions” on page 101.
 - ❖ Configure the connected devices. See each device’s operation manual.
-

- NOTE This feature is limited to models incorporating Toshiba’s HDMI® CEC Control feature. However, Toshiba is not liable for those operations. See the individual instruction manuals for compatibility information.
-

When using an external AV amplifier the picture and sound may not be properly synchronized. In this case, adjust the delay time of the sound on the AV amplifier.

- NOTE The control range of the delay time differs according to the device you use.
-

Connecting an HDMI® audio system

If your HDMI® amplifier supports ARC, audio from the TV can be sent to the amplifier via an existing HDMI® cable.

You will need an HDMI® cable.

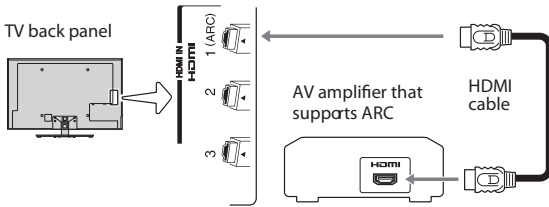

(Sample Illustration) L6200U/L7200U Series— Connecting to HDMI® ARC

HDMI®'s ARC (Audio Return Channel) feature

This feature enables the audio signal of the TV to be sent to an AV amplifier via the HDMI® cable. It will not be necessary to connect a cable from the audio output of the TV to the audio input of the AV amplifier to reproduce the audio received from the tuner of the TV through the AV amplifier.

Connecting a computer

With either the PC IN or HDMI® connection, you can view your computer's display on the TV and hear the sound from the TV's speakers.

Connecting a computer to the TV's PC IN terminal:

When connecting a computer to the PC IN terminal on the TV, use an analog RGB (15-pin) computer cable and a PC audio cable. For more information, see [“Overview of cable types”](#) on page 27.

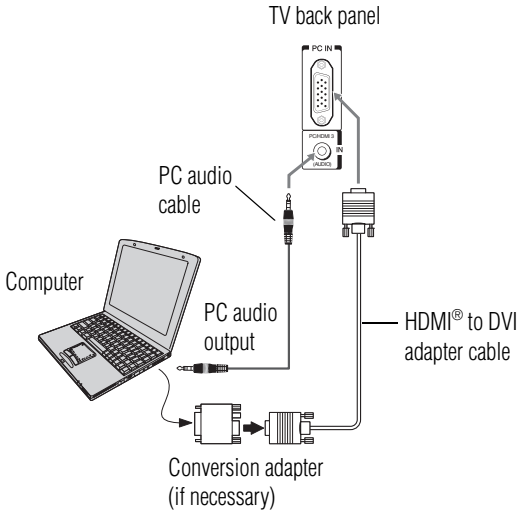

(Sample Illustration) L6200U/L7200U Series—Connecting to a computer through analog RGB cable

To use a computer, set the monitor output resolution on the computer before connecting it to the TV. The supported signal formats are VGA, SVGA, XGA, WXGA and SXGA. For detailed signal specifications, see [“Acceptable signal formats for PC IN, HDMI®, and 3D”](#) on page 195.

Other formats or non-standard signals will not be displayed correctly.

To display the optimum picture, use the computer setting feature, see [“Using your computer with the TV”](#) on page 102.

NOTE

- ❖ The PC audio input terminal on the TV is shared with the HDMI 4 and ColorStream® HD2 terminal. For configuration information, see “Setting the computer audio” on page 103.
- ❖ Some computer models cannot be connected to this TV.
- ❖ If the computer has a compatible mini D-sub15-pin terminal, an adapter is not required.
- ❖ Depending on the content's title and the computer's specifications, some scenes may be skipped or you may not be able to pause during multi-angle scenes.

Signal names for mini D-sub 15-pin connector:

<i>Pin No.:</i>	<i>Signal Name:</i>	<i>Pin No.:</i>	<i>Signal Name:</i>	<i>Pin No.:</i>	<i>Signal Name:</i>
1	R	6	Ground	11	NC
2	G	7	Ground	12	NC
3	B	8	Ground	13	H-sync
4	NC*	9	NC	14	V-sync
5	NC	10	Ground	15	NC

*NC=Not connected

Connect a computer to the TV's HDMI® terminal

When connecting a computer with a DVI port to the HDMI® terminal on the TV, use an HDMI® to DVI adapter cable and analog audio cables.

When connecting a computer with an HDMI® port, use an HDMI® cable (type A connector). Separate analog audio cables may not be necessary, depending on computer hardware and setup.

For more information, see “Overview of cable types” on page 27.

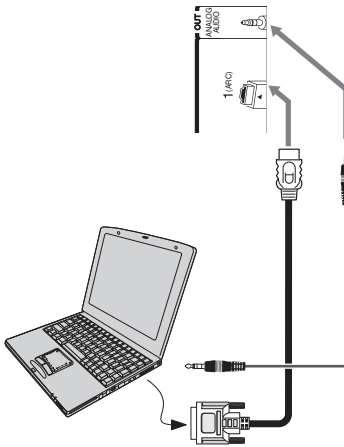

(Sample Illustration) L6200U/L7200U Series—Connecting to an HDMI® terminal

The supported signal formats are VGA, SVGA, XGA, WXGA, SXGA, 480i (60Hz), 480p (60Hz), 720p (60Hz), 1080i (60Hz), and 1080p (24Hz/60Hz). For signal specifications, see “Acceptable signal formats for PC IN, HDMI®, and 3D” on page 195.

NOTE

- ❖ The edges of the picture may be hidden.
- ❖ If receiving a 480i (HDMI), 480p (HDMI), 720p, 1080i, or 1080p signal program, Native mode scales the video to display the entire picture within the borders of the screen (i.e. no overscanning).

Connecting to a home network

The LAN port allows your Toshiba TV to connect to your home network.

You can use this home network to access photos, movies, and music files that are stored on a Connected Media Server and play them on your TV.

Connecting the TV directly to a computer without an Internet connection

You will need a Crossover LAN cable.

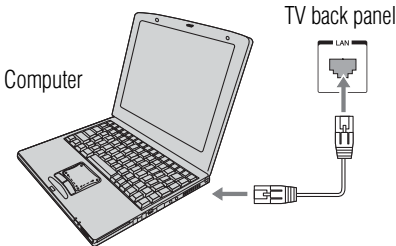

(Sample Illustration) L6200U/L7200U Series—Connecting a computer without Internet connection

Connecting the TV to a home network without an Internet connection

Items needed:

- ❖ Standard LAN cables
- ❖ Router with a hub

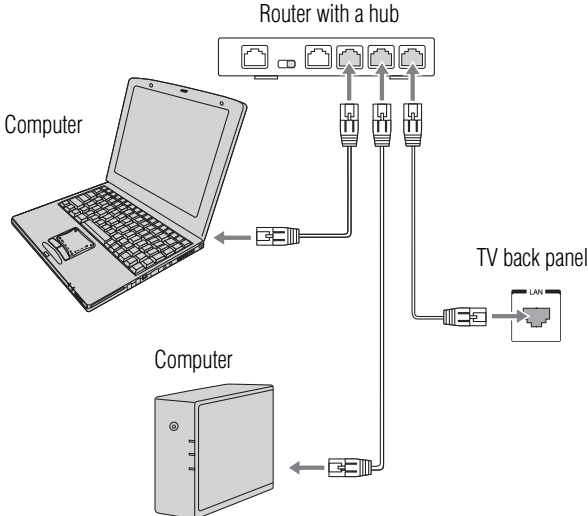

(Sample Illustration) L6200U/L7200U Series—Connecting a network without Internet connection

Connecting the TV to a home network with an Internet connection - wired

Items needed:

- ❖ Coaxial or telephone cable (depending on your modem type)
- ❖ Standard LAN cables
- ❖ Router with Hub
- ❖ Modem (DSL or cable)

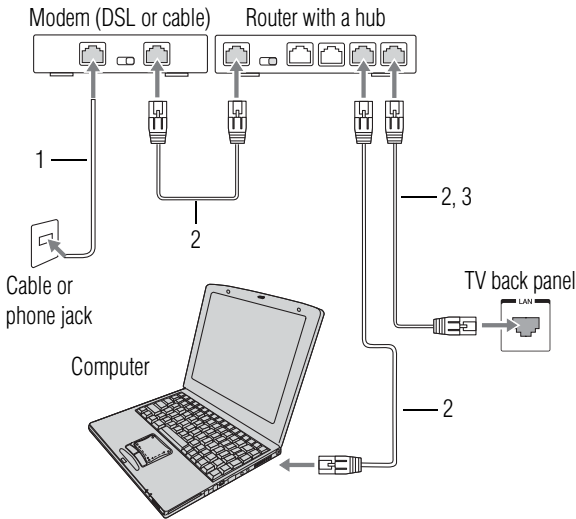

(Sample Illustration) L6200U/L7200U Series—Connecting with Internet connection - wired

Item:	Description:
1	Coaxial or telephone cable (depending on your modem type)
2	Standard LAN cable
3	Do NOT connect a phone jack directly to the TV's LAN port.

Connecting the TV to a home network with an Internet connection - wireless

Items needed:

- ❖ Coaxial or telephone cable (depending on your modem type)
- ❖ Standard LAN cables

- ❖ Wireless LAN access point or wireless router
- ❖ Modem (DSL or cable)

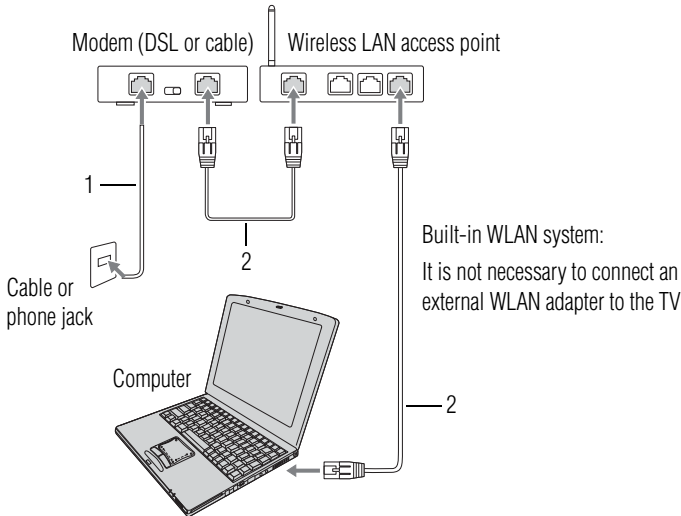

(Sample Illustration) L6200U/L7200U Series—Connecting with Internet connection - wireless

Item:	Description:
-------	--------------

1	Coaxial or telephone cable (depending on your modem type)
2	Standard LAN cable

The transmission speed over the wireless LAN and the distance over which wireless LAN can reach may vary depending on surrounding electromagnetic environment, obstacles, access point design and configuration, and client design and software/hardware configurations. The actual transmission speed will be lower than the theoretical maximum speed.

NOTE

The Built-in WLAN Adapter is based on the IEEE 802.11n specification and may not be fully compatible with, or support some features (e.g., security) of certain Wi-Fi equipment that are based on the draft version of IEEE 802.11n.

Chapter 3

Using the Remote Control

Controlling other devices

The TV's remote control can operate other devices as described in the IR Blaster section on page 55.

Installing batteries

To install batteries:

- 1 Pull up to open the cover.

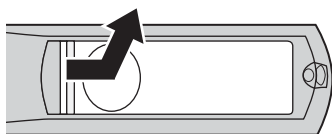

(Sample Illustration) Removing the battery cover

- 2 Install two AA size batteries.

NOTE Use carbon zinc batteries or alkaline batteries.

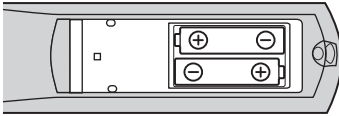

(Sample Illustration) installing the batteries

3 Slide on the cover.

CAUTION Do not expose batteries to excessive heat such as sunshine, fire, etc.

- NOTE
- ❖ Every time you change the batteries, you must reprogram the remote.
 - ❖ Dispose of batteries in a designated disposal area.
 - ❖ Always consider the environment when disposing of batteries. Always follow applicable laws and regulations.
 - ❖ If the remote does not operate correctly, or if the operating range is reduced, replace the batteries.
 - ❖ Always replace both batteries with new ones. Never mix battery types or use new and used batteries together.
 - ❖ Always remove batteries from the remote if they are dead or if the remote control is not to be used for an extended period of time. This prevents battery acid from leaking into the battery compartment
-

Remote control effective range

- 1 For optimum performance, aim the remote control directly at the TV and make sure there are no obstructions between the remote control and the TV.

42/47/55"

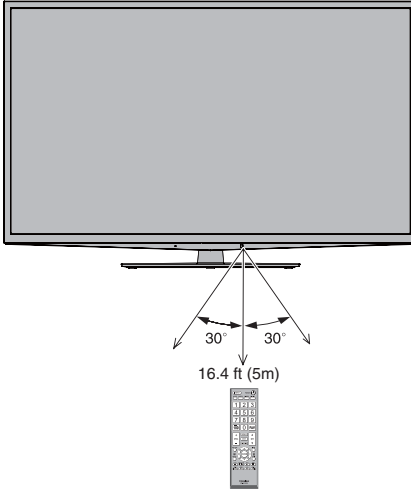

(Sample Illustration) Remote control effective range

Learning about the remote control

Only the buttons used to operate the TV are described in this section.

For the HDMI® CEC Control functions, see “Using HDMI® CEC Control” on page 97.

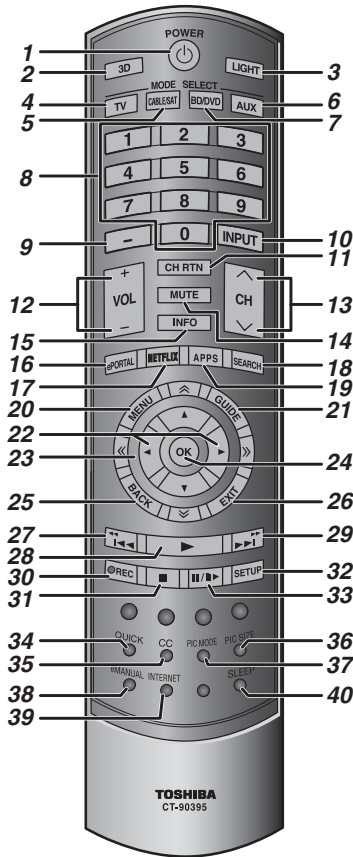

(Sample Illustration) Remote control overview

NOTE

The L6200U series remote has no **LIGHT** button. The **LIGHT** button is only available on the L7200U series remote.

NOTE

The error message "NOT AVAILABLE" may appear if you press a key for a function that is not available.

Item:	Description:	Function:	Item:	Description:	Function:
1	POWER button	Turns the TV On and Off. When the TV is on, the power LED indicator on the TV front glows green.	21	GUIDE button	Launches the MediaGuide application on-screen.
2	3D button	Accesses the 3D options.	22	(◀/▶) buttons	Selects on-screen menu options.
3	Light button (Model L7200U)	Illuminates the keypad for five seconds.	23	(▲/▼/◀/▶)	Selects or adjusts programming buttons menus when a menu is on-screen.
3	Sleep button (Model L6200U)	Accesses the sleep timer.	24	OK button	Selects the highlighted items on the screen.
4	TV button	Switches to the TV input assigned to each mode key: TV, CABLE/SAT, BD/DVD, or AUX.	25	BACK button	Returns to the previous screen.
5	Cable/Satellite button		26	EXIT button	Closes on-screen menus.
6	Auxillary button		27	REWIND button	Short press rewinds/fast forwards. Long press skips back/forward and plays playback.
7	BD/DVD button		28	PLAY button	
8	Channel Number buttons (0-9)	Directly tunes channels.	29	FAST FOWARD	
9	(-) button	Enters 2-part channel numbers.	30	REC button	Used for TV, Cable/Sat, BD/DVD, Aux devices
10	INPUT button	Selects the video input source.	31	STOP button	Stops playback
11	CH RTN button	Returns to the last viewed channel or source.	32	SETUP button	Used for TV, Cable/Sat, BD/DVD, Aux devices
12	VOL (+/-) buttons	Adjusts the volume level.	33	PAUSE button	Pauses playback
13	CH (▲/▼) buttons	Cycles through programmed channels.	34	QUICK button	Launches the Quick menu.
14	MUTE button	Reduces or turns off the sound.	35	CC button	Accesses the closed-caption feature.
15	INFO button	Displays TV status information as well as program details, when available.	36	PIC SIZE button	Cycles through the picture sizes.
16	ePORTAL button	Launches the ePortal page on-screen.	37	PIC MODE button	Selects the picture mode.
17	NETFLIX button	Launches the Netflix® application on-screen.	38	eMANUAL button	Launches the eMANUAL application on-screen. Internet connection required.
18	SEARCH button	Accesses the SearchAll function.	39	INTERNET button	Launches the web browser on-screen.
19	APPS button	Launches the Apps window on-screen.	40	SLEEP button (Model L7200U)	Accesses the sleep timer.
20	MENU button	Accesses the main TV menu system.			

Chapter 4

Initial Setup and Menu

Initial setup

When you first turn on or reset the TV, the Initial Setup window appears.

- NOTE
- ❖ You can stop Initial Setup by pressing the **EXIT** button. However, if you do not finish Initial Setup, the Initial Setup screen will appear every time you turn on your TV. To finish Initial Setup, see [“Changing initial settings” on page 64](#).
 - ❖ The **EXIT** button does not work until Menu Language/Country, Time Zone/Daylight Saving Time, and Store/Home Mode have been set.
-

Performing the initial setup

1 Menu Language/Country

Select a language and country. Press **OK**.

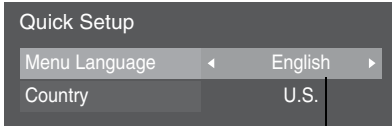

Language

(Sample Illustration) Selecting Menu Language/Country

2 Time Zone

Select a time zone.

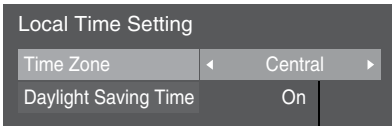

Time zone

(Sample Illustration) Selecting Time Zone

3 Daylight Saving Time

Select **On** or **Off**. Press **OK**.

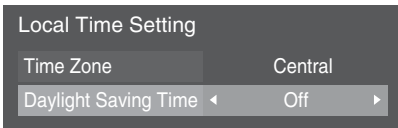

(Sample Illustration) Selecting Daylight Saving Time

4 Store/Home Mode

Select **Store** or **Home**. Press **OK**.

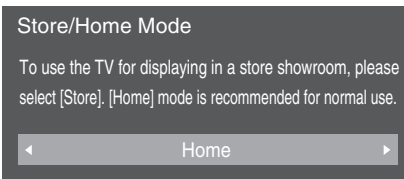

(Sample Illustration) Selecting a location

5 ANT/CABLE

To select **Antenna**, first select **Antenna**. Then select **Next**.

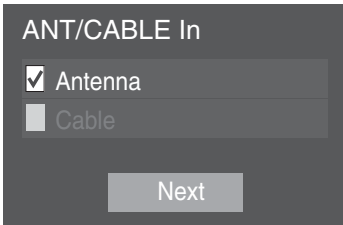

(Sample Illustration) Selecting Antenna

To select **Cable**, first select **Cable**. Then select **Next**.

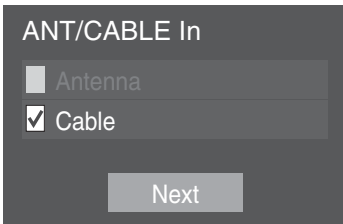

(Sample Illustration) Selecting Cable

NOTE If you do not want to scan channels, you do not need to make a selection for ANT/CABLE. Select **Next**, and then press **OK** to skip this step.

6 Start Scan

Select **Start Scan**. Press **OK**.

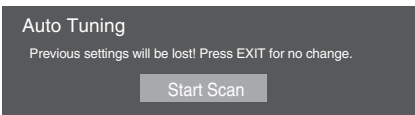

(Sample Illustration) Start Scan

NOTE If you want to stop scanning, pressing the **EXIT** button while scanning is in process.

While scanning is in progress, the Auto Tuning Progress Screen appears.



(Sample Illustration) Auto Tuning Progress Screen

After scanning is complete, the auto tuning results screen (such as the one below) will appear.

Press **OK** or **EXIT**.

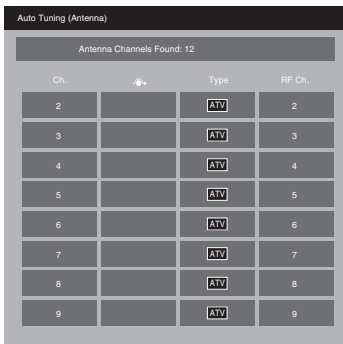

(Sample Illustration) Auto Tuning Results screen

NOTE

Although they may be displayed in the above list, encrypted channels cannot be viewed.

If some channels are not found after scanning:

- ❖ Check the antenna/cable connections, and scan again.
- ❖ Connect the TV to the antenna or cable box directly and scan again.
 - 1 Press the **MENU** button. Select **SETTINGS, SETUP, Quick Setup**, and then press **OK**.
A confirmation message appears.
 - 2 Press the (◀/▶ arrow) buttons to select **Yes**. Press **OK**.
 - 3 Repeat setup to Step 6.
 - ❖ If you selected **Antenna** previously, select **Cable**.
 - ❖ If you selected **Cable** previously, select **Antenna**.

- 4 Scan again.

IR Blaster Setup

During the Initial Setup, the IR Blaster screen will appear with the message, “IR Blaster setup will now begin. If you wish to skip, please select Skip.”

To start the IR Blaster setup, select **Next** on the screen, or to skip the setup, select **Skip**. If you wish to skip this setup, you can setup the IR Blaster at any time through the PREFERENCES menu.

NOTE The IR Blaster may not work with some devices, and it may not control certain features on your external devices.

- 1 The IR Blaster Setup screen will appear and you must choose what devices to setup.
- 2 Select the **Add** button on the screen to add devices.
- 3 The IR Blaster Setup Add devices screen will appear. The Device Type field will be highlighted.
- 4 Use the (◀/▶ arrow) buttons to select:
 - ❖ Cable Box
 - ❖ Satellite Box
 - ❖ VCR
 - ❖ Blu-ray™/DVD Player
 - ❖ Audio
 - ❖ CD Player
 - ❖ Video Accessory

The first column on the screen lists the subsequent fields including: Brand, Select Device, Model Name, TV Input, etc.

- 5 Use the (▲/▼ arrow) buttons to select the options in the second column that correspond to the IR device currently being setup. Some fields will have screens with selectable lists of items, while other fields may require using the keyboard to enter the information.
- 6 To select the Code Set, use the (◀/▶ arrow) buttons to select the codes set for the device.

NOTE If a model has more than one Code Set, a message will appear stating “This model has more than one Code Set. Please select and test your preferred Code Set.” You will need to choose a code set using the (◀/▶ arrow) buttons and perform the Test option to ensure the correct Code Set has been selected.

NOTE The Test option is available when the Device Type, Brand, Model Name/Code Set have all been setup.

- 7** To select the TV Input to which the IR device is connected, use the (◀/▶ arrow) buttons to select from the following options:
- ❖ (Only audio is selected as this device type)
 - ❖ Video 1
 - ❖ Video 2
 - ❖ ColorStream HD 1
 - ❖ Colorstream HD 2 (If selected)
 - ❖ HDMI 1
 - ❖ HDMI 2
 - ❖ HDMI 3
 - ❖ HDMI 4
 - ❖ PC (if selected).
-

NOTE PC or ColorStream HD2 inputs depend on the shared PC input.

- 8** To set up the Guide Control, use the (◀/▶ arrow) buttons to select:
- ❖ TV (this is the default)
 - ❖ Device
- 9** To set up the Volume control, use the (◀/▶ arrow) buttons to select:
- ❖ TV (this is the default)
 - ❖ Amplifier

If the Amplifier option is selected, the **Volume Up/Down** and **MUTE** buttons will control the amplifier through the IR blaster.

NOTE If Audio is selected as the device type, the volume option is active. However if another device (other than Audio) is selected, then this option is not available and grayed out.

- 10** After setting up all the options for the device, it is important to test the IR Blaster's control of the device by using the **Test** option.
- 11** Once you have selected all the appropriate information on the screen, use the (▲/▼ arrow) buttons to select the **Done** button. To cancel this screen and return to the previous screen, select the **Cancel** button.

To test the IR Blaster's control of the device:

- 1** Use the (▲/▼ arrow) buttons to select the **Test** option from the IR Blaster Setup screen.

The TV will then send the power on and power off command to the device through the IR Blaster with approximately a 5 second interval.
- 2** A message screen will appear asking you "Was your device powered on and off by the IR Blaster? If not, please check your device and IR blaster position." If the test failed, a "Test Failed" message will appear on the screen.

To setup the timing control for your device:

- 1** Use the (▲/▼ arrow) buttons to select **Timing Control**. A screen will appear allowing you to set up the Interval Time for the device.
- 2** Use the (◀/▶ arrow) buttons to select from the following options:
 - ❖ 0.125 sec
 - ❖ 0.25 sec (this is the default)
 - ❖ 0.375 sec
 - ❖ 0.5 sec
 - ❖ 0.625
 - ❖ 0.75
 - ❖ 0.875
 - ❖ 1 sec

3 Select the **Test** button.

A message screen will appear asking you “Was your device changed from one channel to another by the IR blaster? If not, please check your configuration.” If the test failed, a “Test Failed” message will appear on the screen.

4 Once you have selected all the appropriate information on the screen, use the (▲/▼ arrow) buttons to select the **Done** button. To cancel this screen and return to the previous screen, select the **Cancel** button.

NOTE

- ❖ When the **Done** button is selected, if the TV input has already been selected for another device an Alert Screen will appear.
 - ❖ When the **Done** button is selected, if the HDMI input has already been selected for another HDMI® CEC device an Alert Screen will appear.
 - ❖ When the **Done** button is selected, if the Device Type selected is the Cable Box, Satellite Box or Blu-ray™ DVD Player, the following message will be displayed: “Are you sure you want to apply this device to MediaGuide?” You must select the **Yes** or **No** option using the (◀/▶ arrow) buttons. After this selection, the IR Blaster Setup main screen will appear.
 - ❖ The HDMI® CEC control function has priority over the IR Blaster function when HDMI and HDMI® CEC devices are connected. If the IR Blaster is already setup, the IR Blaster function should be stopped when the same HDMI port is being used with at least one HDMI® CEC device.
-

Network Setup

During the Initial Setup, the Network Setup screen will appear with the message, “Network Setup will now begin. If you wish to skip, please select Skip.” To start the Network Setup, select Next on the screen or to skip the setup, select Skip. If you wish to skip this setup, you can setup the Network at any time through the **NETWORK** menu.

In order to setup your network, you must first select the type of network you wish to set up:

1 Use the (◀/▶ arrow) buttons to select Wired or Wireless network.

If you select Wired, proceed to the Network Connection Test (Step 3). If you selected Wireless network, please proceed to the following step.

-
- Using the (▲/▼ arrow) buttons, select the type of Wireless setup option: Easy Setup (WPS), Assisted Setup, or Manual Setup.

NOTE

- ❖ Easy Setup (WPS). If your Access Point (AP) supports WPS, this method can be used. WPS is a standard designed to simplify the connection of wireless LAN equipment and the setup of network security features.
- ❖ Assisted Setup (setup using the AP's notification information). The Network Name, Authentication, and Encryption are decided based on information from the AP. You need to manually set the Security Key for this method.
- ❖ Manual Setup (to input all settings manually).

-
- Once your wired or wireless network has been configured, perform a Network Connection Test.

A network connection test screen will appear while the test is being performed. If the test was successful, the successful connection screen will appear.

If the network connection test failed, the connection failure screen will appear.

For more information, see [“Setting up the Network” on page 131](#).

- Press the **OK** button on the screen to return to the Initial Setup menu.

NOTE

In order to secure your home network, it is strongly recommended that you use a wireless access point with encryption.

MediaGuide Setup

During the Initial Setup, the MediaGuide screen will appear with the message, “MediaGuide setup will now begin. If you wish to skip, please select Skip.” To start the MediaGuide Setup, select **Next** on the screen, or to skip the setup, select **Skip**. If you wish to skip this setup, you can setup the MediaGuide at any time through the setting menu of the MediaGuide application.

To setup your MediaGuide:

When you select **Next** (as described above) the Connect to the Network screen will appear.

- 1 Make sure the TV is connected to the network, and then select the **Yes** or **No** button using the (◀/▶ arrow) buttons. Then press the **OK** button.

The TV will now establish connection with the information services it uses. A confirmation screen will appear if the connection was established.

- 2 Press the **OK** button on the confirmation screen.

If the TV is unable to connect to these services from the network, an error message appears.

NOTE If the error message appears, you should check your network connections and try again.

For more information, see “[Setting up the Network](#)” on page 131.

The Online Account Setup will appear. Please follow the onscreen instructions to register the guide.

NOTE If you wish to select any other service subscription such as Netflix®, you may complete this on the website as well.

After completion of the network connection check, a new screen will appear describing the terms and conditions.

- 3 Use the arrow buttons to select the **I Agree** button on the screen.

The Zip/Postal Code screen will appear.

- 4 Use the number buttons to enter your zip code. Press the **Continue** button.

The Choose Provider screen will appear.

- 5 Use the (▲/▼ arrow) buttons to select your service provider from the list.

After completion of all of these steps, the MediaGuide will start up.

Support Information

- ❖ When the “Support Information” screen appears, press the **OK** button.

NOTE Refer to this information if there is a problem and you need to contact Customer Support. To find help, the following operation can be performed at any time. **MENU** button > **Menu** > **GET HELP** > **System Information** > **OK** button.

Navigating the menu system

- ❖ To open the menu system, press the **MENU** button on the remote control or TV control panel.



(Sample Illustration) Main menu

- ❖ When a menu is open, press the (▲/▼/◀/▶ arrow) buttons on the remote control to move in the corresponding direction.
- ❖ To select a highlighted item or save your menu settings, press the **OK** button. (A highlighted menu item appears in a different color in the menu.)
- ❖ All menus close automatically if no selection is made within approximately 60 seconds.
- ❖ To close a menu instantly, press the **EXIT** button.

Main menu layout

To open the main menus in the table below, press the **MENU** button on the remote control or TV control panel.

<i>1st Layer</i>	<i>2nd Layer</i>	<i>3rd Layer</i>	<i>Page</i>
GET HELP	Software Licenses		page 141
	Software Upgrade		page 140
	System Information		page 107
	eMANUAL		page 142
3D		3D Auto Start	page 81
		2D to 3D Depth	page 84
		3D PIN	page 81
		3D Safety Settings	page 83
		3D Important Information	page 72
SETTINGS	SOUND	SOUND Menu	page 125
	PICTURE	PICTURE Menu	page 115
	PREFERENCES	PREFERENCES Menu	page 64
	SETUP	SETUP Menu	page 64
NETWORK	Media Player Setup		page 157
	Network Setup		page 131
	Network Device Setup		page 136
	Smart Apps Setup		page 142
TIMERS	On Timer		page 104
	Sleep Timer		page 105
	Game Timer		page 96

Quick Menu

Quick menu helps you access some options more quickly.

Press the **QUICK** button to display the Quick menu and press the (▲/▼) buttons to select an option.

NOTE Quick menu items differ depending on the current mode.

<i>Quick Menu Item</i>	<i>Page</i>
Picture Mode	page 79
3D Settings	page 78
HDMI [®] CEC Player Control	page 99
Speakers	page 165
Wireless Information	page 135
Interval Time	page 165
Repeat	page 161
Device Information	page 160
SOUND	page 165
PICTURE	page 79

Chapter 5

Setting up your TV

How to navigate the menu

- ❖ Press the **MENU** button. Select **SETTINGS**, Main menu, Submenu, and then press the **OK** or **EXIT** button.

<i>Format:</i>	<i>Description:</i>
MENU	Press the MENU button.
SETTINGS	Press the (◀/▶ arrow) buttons to select SETTINGS.
Main menu	Press the (◀/▶ arrow) buttons to select a menu icon (SOUND, PICTURE, PREFERENCES, SETUP, GET HELP, 3D, SETTINGS, NETWORK, TIMERS)
Submenu	Press the (▲/▼ arrow) buttons to select a menu.
OK	Press the OK button.

Changing initial settings

From Quick Setup:

- 1 Press the **MENU** button.
- 2 Select **SETTINGS**, **SETUP**, **Quick Setup**, and then press the **OK** button.

A confirmation message appears.

- 3 Press the (◀/▶ arrow) buttons to select **Yes**.
- 4 Press the **OK** button.

To change settings, see “Initial setup” on page 51.

Individual settings

Menu Language

You can choose from three different menu language settings (English, Français, and Español). The TV displays menus and messages in your preferred language. You can also select the country in which you reside.

- 1 Press the **MENU** button.
- 2 Select **SETTINGS, SETUP**, and then **Menu Language**.
- 3 Press the (◀/▶ arrow) buttons to select your preferred language.
- 4 Press the (▼ arrow) button to select **Country**.
- 5 Press the (◀/▶ arrow) buttons to select the country.

Local Time

This setting allows you to specify the correct time zone for your region.

- 1 Press the **MENU** button.
- 2 Select **SETTINGS, SETUP, TV Settings**, and then press the **OK** button.
- 3 Press the (▲/▼ arrow) buttons to select **Local Time**.
- 4 Press the **OK** button.
- 5 Select an option:
 - ❖ **Time Zone**
 - ❖ **Daylight Saving Time**
- 6 Press the (◀/▶ arrow) buttons to select your time zone or select **On** to activate Daylight Saving Time.

Store/Home Mode

You can select **Store** or **Home** to designate the TV location. Select **Home** for normal home use.

- 1 Press the **MENU** button.
- 2 Select **SETTINGS, SETUP**, and then **Store/Home Mode**.

- 3 Press the (◀/▶ arrow) buttons to select **Home**.
- 4 Press the **OK** button.

ANT/CABLE In

This setting configures the antenna input source for the ANT/CABLE terminal.

- 1 Press the **MENU** button.
- 2 Select **SETTINGS, SETUP**, and then **ANT/CABLE In**.
- 3 Select **Antenna** or **Cable** and press **Next**.
- 4 Select **Cable** and press **Next**.

NOTE If you do not want to scan channels, you do not need to make a selection for ANT/CABLE. Select **Next** and press **OK** to skip this step.

- 5 Select **Start Scan**.
After scanning is complete, the auto tuning results screen will appear.
- 6 Press **OK** or **EXIT**.

Storing channels in memory (optional)

To make sure your TV stops only on the channels you want when you press the **CH Up/Down** arrow buttons on the remote control or the control panel, store those channels in the TV's memory.

Auto Tuning

NOTE You must set up the antenna/cable input source first. See "[Initial setup](#)" on page 51.

You can set up the TV to detect all active channels in your area and store them in its memory. Then you can manually store or skip individual channels from memory.

<i>Option:</i>	<i>Description:</i>
Cable	Note: If you select Cable, auto tuning deletes previously stored channels from memory. This setup requires some time, but you do not need to repeat the setup unless your cable TV service's lineup changes significantly.

<i>Option:</i>	<i>Description:</i>
Antenna	Auto tuning retains stored channels and stores newly found channels into memory. To skip an antenna source channel and remove it from memory, set the channel to be skipped. See "Skipping channels" on page 68.

NOTE To tune to channels not stored in memory, use buttons 0–9 and the DASH button on the remote control.

- 1** Press the **MENU** button.
- 2** Select **SETTINGS, SETUP, Auto Tuning**, and then press the **OK** button.
A confirmation screen appears.
- 3** Press the **OK** button to start Auto Tuning or press the **EXIT** button to abort.
The TV cycles through the channels and stores all active channels in memory.
- 4** To view the programmed channels, press the **CH Up/Down** arrow buttons.

Manual Tuning

After storing channels in memory, you can manually enter channels if the channel number is known.

- 1** Press the **MENU** button.
- 2** Select **SETTINGS, SETUP, Manual Tuning**, and then press the **OK** button.
- 3** Use buttons 0–9 on the remote control to enter the channel number (for example, 56).
- 4** Press the **OK** button.
- 5** Press the **OK** button again to begin Manual Tuning.

The channels found are listed at the bottom of the screen.

<i>Option:</i>	<i>Description:</i>
ATV	Analog channel
DTV	Digital channel

Skipping channels

To prevent a channel from being viewed, you can set it to be skipped.

- 1 Press the **MENU** button.
- 2 Select **SETTINGS**, **SETUP**, **TV Settings**, and then press the **OK** button.
- 3 Press the (**▲/▼** arrow) buttons to select **Channel Options**, and then press the **OK** button.

The list of channels appears.

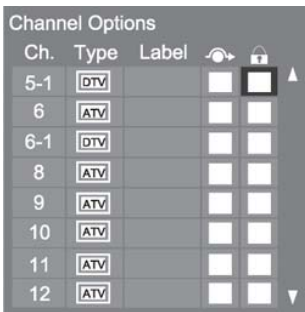

(Sample Image) Channel options

- 4 Move to the Skip column () and press the (**▲/▼** arrow) buttons to select a channel to skip.
- 5 Press the **OK** button.
The box is selected.
- 6 To clear the selection, press the **OK** button.

NOTE

You cannot tune skipped channels using the CH Up/Down arrow buttons. Use buttons 0–9 and the DASH button on the remote control.

Skipping video inputs

You can set video inputs to be skipped when selecting inputs in the Input selection window.

To turn on skip

- 1 Press the **MENU** button.

- 2 Select **SETTINGS, PREFERENCES, AV Connection**, and then press the **OK** button.
- 3 Press the (▲/▼ arrow) buttons to select **Input Labeling**.
- 4 Press the **OK** button.
- 5 Press the (▲/▼ arrow) buttons to select the item you wish to skip. Then press the **RED** button to turn on **Skip**.

To turn off skip

Press the **RED** button again to turn off **Skip**.

Labeling analog TV channels

- 1 Press the **MENU** button.
- 2 Select **SETTINGS, SETUP, TV Settings**, and then press the **OK** button.
- 3 Press the (▲/▼ arrow) buttons to select **Channel Options**, and then press the **OK** button.

The list of channels appears.

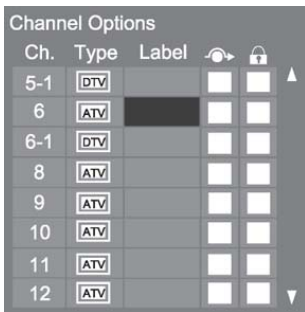

(Sample Image) Channel options

- 4 Press the (▲/▼ arrow) buttons to select a channel to label.
- 5 Press the **OK** button.
The Software Keyboard window appears.
- 6 Input a name using the Software Keyboard, see [“Using the software keyboard” on page 139](#).
- 7 Press the **BLUE** button.

Labeling video inputs

The input labels are shown in the input selector and banner displays. You can label video inputs according to the devices you have connected to the TV.

- 1 Press the **MENU** button.
- 2 Select **SETTINGS, PREFERENCES, AV Connection**, and then press the **OK** button.
- 3 Press the (**▲/▼** arrow) buttons to select **Input Labeling**, and then press the **OK** button.
- 4 Press the (**▲/▼** arrow) buttons to select the item you wish to label. Press the (**◀/▶** arrow) buttons to select **Receiver, Cable, DVD, Game, PC, Recorder, Satellite, VCR** or **Blu-ray™**.
- 5 Repeat Step 4 for other video inputs.

Configuring shared inputs

To set Shared AV Audio

- 1 Press the **MENU** button.
- 2 Select **SETTINGS, PREFERENCES, AV Connection**, and then press the **OK** button.
- 3 Press the (**▲/▼** arrow) buttons to select **Video 1/ColorStream HD1 Audio/HDMI 3 Audio**.
- 4 Press the (**◀/▶** arrow) buttons to select **ColorStream HD1, Video 1**, or **HDMI 3**.

To set Shared PC Audio

- 1 Press the **MENU** button.
- 2 Select **SETTINGS, PREFERENCES, AV Connection**, and then press the **OK** button.
- 3 Press the (**▲/▼** arrow) buttons to select **PC/HDMI 4 Audio**.
- 4 Press the (**◀/▶** arrow) buttons to select **PC** or **HDMI 4**.

Setting the Auto Input feature

You can change TV inputs using the **MODE SELECT** buttons on the remote control: **TV, CABLE/SAT, BD/ DVD**, or **AUX**. After setting an input for a specific **MODE SELECT** button, the TV automatically switches to the input.

Auto Input settings options for each **MODE SELECT** button:

<i>Option:</i>	<i>Description:</i>
TV	ANT/CABLE
CABLE/SAT	ANT/CABLE, Video 1 Video 2 ColorStream HD1, HDMI 1, HDMI 2, HDMI 3, HDMI 4, PC
BD/DVD	Video 1 Video 2 ColorStream HD1, HDMI 1, HDMI 2, HDMI 3, HDMI 4, PC
AUX	ANT/CABLE, Video 1 Video 2 ColorStream HD1, HDMI 1, HDMI 2, HDMI 3, HDMI 4, PC

NOTE The TV mode select button will be restricted to the ANT/CABLE input.

To set Auto Input

- 1 Press the **MENU** button.
- 2 Select **SETTINGS, PREFERENCES, Mode Select Key Setup**, and then press the **OK** button.
- 3 Press the (◀/▶ arrow) buttons to select **On** or **Off**.
- 4 Press the (▲/▼ arrow) buttons to select the mode you wish to set.
- 5 Press the (◀/▶ arrow) buttons to select an input source for that mode.
- 6 Repeat the procedure for other modes.

To turn off Auto Input

- ❖ Select **Off** in Step 3.

To reset Auto Input

- ❖ Select **Reset**, and then press the **OK** button.

Chapter 6

Basic features

Viewing 3D images

Before using the 3D function, note the following:

In addition to compatible 3D glasses, viewing 3D programming requires the following (not included):

- ❖ Compatible 3D playback device or 3D source.
- ❖ 3D capable HDMI® cable.

If you wish to obtain extra 3D glasses:

Toshiba provides 3D glasses for this television as an option.
To obtain them visit:

US: <http://ceaccessories.toshiba.com/>

Canada: <http://www.shoptoshiba.ca/>

NOTE

Use the type of 3D glasses that are compatible with to your TV.

CAUTION Health precautions:

- ❖ Due to the possible impact on vision development, viewers of 3D programming should be age 6 or above. Children may be more susceptible to health effects from viewing 3D images and should be closely supervised.
 - ❖ Some viewers may experience a seizure or blackout when exposed to certain flashing images or lights contained in certain 3D television pictures or video games. Anyone who has had a seizure, loss of awareness, or other symptom linked to an epileptic condition, or has a family history of epilepsy, should contact a health care provider before using the 3D function of this product.
-

CAUTION Handling the 3D glasses:

- ❖ When cleaning the 3D glasses, gently wipe with a dry, soft cloth. First, remove any dirt or dust from the 3D Glasses. Harsh rubbing or use of a dirty or coarse cloth will scratch the 3D Glasses. Do not use benzene, paint thinner, alcohol, water, or abrasive cleaners, which may damage the 3D glasses.
 - ❖ When not using the 3D glasses, store them away from high temperatures and humidity.
 - ❖ Do not store the 3D glasses in areas of extreme heat or cold, as deformation can occur. If deformation occurs, replace the 3D glasses.
 - ❖ The lenses of the 3D glasses are different from those of ordinary glasses, and are very thin. Be very careful in handling the 3D glasses as the lens can pop out easily.
 - ❖ Do not put excessive force on the lenses.
 - ❖ Do not scratch the surface of the lenses with sharp objects.
 - ❖ Do not drop or bend the 3D glasses.
 - ❖ Do not use benzene, paint thinner, alcohol, water, or abrasive cleaners, which may damage the 3D glasses.
 - ❖ The 3D glasses are not subject to repair. If the glasses are broken or scratched, purchase a new pair of 3D glasses.
 - ❖ The 3D glasses are not subject to repair, but can be replaced if a problem occurs due to an initial fault with the glasses
-

NOTE

Watching the TV:

- ❖ Proper 3D effects or 3D-to-2D conversion results may not be obtained depending on the received 3D content.
 - ❖ 3D effect and image quality may vary depending upon content quality and display device capability/ functionality/settings.
 - ❖ Wear the 3D glasses properly, otherwise you may not see the correct 3D images.
 - ❖ When not viewing 3D images, take off the 3D glasses; otherwise, it may be difficult to see the display on other products such as your computer, digital clock, or calculator, etc.
 - ❖ Use the 3D glasses at the proper viewing angle and distance, see “[Safety Precautions for 3D glasses](#)” on page 6.
-

NOTE

Use a high-speed HDMI® cable when you connect a device such as a 3D compatible Blu-ray Disc™ player or computer to the TV. When you use a standard HDMI® cable, 3D images may not display correctly.

Some functions cannot be shown in 3D mode.

Using 3D functions

Incoming video signals can either be in 2D or 3D format. A 2D signal can be viewed in either 2D or 3D, and 3D can be viewed in either 2D or 3D. If the TV can detect the fact that a signal is 3D, it can change to 3D mode automatically, see “[Setting the 3D start message](#)” on page 82. Otherwise you can change the viewing mode using the 3D button. Finally, the format of the 3D signal can be either Side by Side (SBS) or Top and Bottom (TAB). You may have to choose the correct format if the TV can not detect it automatically, see “[Selecting 3D format from the Quick menu in 3D mode](#)” on page 78.

You can also change 2D images to 3D images by pressing the 3D button when viewing in 2D.

NOTE



- ❖ In order to switch to 3D, the TV must be receiving a 3D signal.
- ❖ If appropriate mode and format are not selected, 3D image is not correctly displayed.
- ❖ If the appropriate 3D mode and format are not selected, the 3D image will not display correctly.
- ❖ There are individual differences in perception of 3D images.
- ❖ When viewing 3D images, wear the 3D glasses.
- ❖ The 2D to 3D conversion function is activated and controlled by you according to your personal preferences.
- ❖ The 2D to 3D conversion function is meant for enjoyment of 2D home video, and other 2D content you create, in 3D according to your personal preferences.
- ❖ It is not intended for unauthorized use of copyrighted works. To the extent that you need to obtain permission from a copyright holder to view copyrighted works, it is your responsibility to obtain such permission.
- ❖ The 2D to 3D conversion function is not intended for use with pre-recorded 2D copyrighted content owned by a third-party unless the copyright owner has given direct or indirect permission, or unless applicable law permits such use. To the extent you need to obtain permission from a copyright holder to view copyrighted works, it is your responsibility to obtain such permission.

Switching display mode or selecting 3D format

There are four TV viewing modes:

<i>Mode:</i>	<i>Description:</i>
3D	Displays 3D images.
2D	Displays 2D images by changing 3D images to 2D.
2D to 3D	Displays 3D images by changing 2D images to 3D.
Native	Displays a received signal format as it is.

3D signals can be sent in one of three formats:

<i>3D Format:</i>	<i>Description:</i>
 Side by Side (SBS)	Images for the left and right eyes are positioned side-by-side.
 Top and Bottom (TAB)	Images for the left and right eyes are positioned at the top and bottom of the screen
 Frame Packing (FP)*	Images for the left and right eyes are positioned at the top and bottom of the screen.

* This format cannot be selected manually.

- ❖ If the right and left images are the same in Native mode, select SBS.
- ❖ If the top and bottom images are the same in Native mode, select TAB.

The 3D button operation

Depending on the input mode, the 3D button function may be different when viewing Native mode.













<i>Input:</i>	<i>Function:</i>
Analog Inputs	Changes the viewing mode to 2D to 3D mode.
HDMI®	Displays the selection window.
Analog Broadcast	Changes the viewing mode to 2D to 3D mode.
Digital Broadcast	Displays the selection window.

<i>Input:</i>	<i>Function:</i>
HDMI with 3D Auto Detect Information	Changes the viewing mode to 3D mode
Internet	Changes the viewing mode to 2D to 3D mode.

NOTE When viewing 3D mode or 2D to 3D mode, pressing the 3D button changes the viewing mode to Native mode.

Switching to 3D mode











- ❖ Set 3D Auto Start to **3D**.
- ❖ Press the **3D** button and select **3D** while viewing 2D mode or Native mode.

<i>Input Signal/Switching Display Mode Trigger</i>				<i>Press 3D Button</i>	
Type	Additional Information	Format	Source Signal	Select 3D	Select 2D to 3D
3D Format Signal	With 3D Auto Detect Information	FP		* 	
		SBS		* 	
		TAB		* 	
2D Format Signal	Without 3D Auto Detect Information	SBS		* 	
		TAB			* 

* Correct 3D image.

Selecting 3D format from the Quick menu in 3D mode













- 1 Press the **QUICK** button. Select **3D Settings**, and then press the **OK** button.
- 2 Press the (▲/▼ arrow) buttons to select **3D Format Select**, and then press the **OK** button.
- 3 Press the (◀/▶ arrow) buttons to select **Side by Side** or **Top and Bottom**.

<i>Input Signal/Switching Display Mode Trigger</i>				<i>Quick menu/ 3D Format Select</i>	
Type	Additional Information	Format	Source Signal	SBS	TAB
3D Format Signal	With 3D Auto Detect Information	FP			
		SBS			
		TAB			
		SBS		* 	
	Without 3D Auto Detect Information	TAB			* 
		2D Format Signal			

* Correct 3D image.

Switching to 2D mode



















- 1 Set 3D Auto Start to **2D**.
- 2 Press the **3D** button while viewing 3D mode.

Input Signal/Switching Display Mode Trigger			Press 3D Button		
Type	Additional Information	Format	Source Signal	Select 3D	Select 2D to 3D
3D Format Signal	With 3D Auto Detect Information	FP		*	
		SBS		*	
		TAB		*	
	Without 3D Auto Detect Information	SBS			
		TAB			
		2D Format Signal		*	

* Correct 2D image.

Selecting 2D format from the Quick menu in 2D mode

- 1 Press the **QUICK** button. Select **3D Settings**, and then press the **OK** button.
- 2 Press the (**▲/▼** arrow) buttons to select **2D Format Select**, and then press the **OK** button.
- 3 Press the (**◀/▶** arrow) buttons to select **Side by Side** or **Top and Bottom**.

Input Signal/Switching Display Mode Trigger				Quick menu/ 3D Format Select		
Type	Additional Information	Format	Source Signal	SBS	TAB	Native
3D Format Signal	With 3D Auto Detect Information	FP				
		SBS		* 		
		TAB			* 	
	Without 3D Auto Detect Information	SBS		* 		
		TAB			* 	
		2D Format Signal				

* Correct 2D image.

NOTE Take off the 3D glasses in 2D mode

Switching to Native mode

Press the **3D** button while viewing 3D mode.

Press the **3D** button while viewing 2D to 3D mode.

NOTE When 3D format signal with 3D Auto Detect Information is received, it is not possible to switch to Native.

Quick menu in 2D mode

- 1 Press the **QUICK** button. Select **3D Settings**, and then press the **OK** button.
- 2 Press the (**▲/▼** arrow) buttons to select **2D Format Select**, then press the **OK** button.
- 3 Press the (**◀/▶** arrow) buttons to select **Native**.

To switch 2D to 3D mode

- ❖ Press the **3D** button and select **2D to 3D** while viewing 2D or Native mode.

NOTE

When using ATV, Video, ColorStream HD, Internet, or PC, the viewing mode can be changed to 2D to 3D mode by pressing 3D.

Setting the auto start mode

This controls what the TV does when it detects a 3D format signal with 3D Auto Detect Information.

- 1 Press the **MENU** button.
- 2 Use the (**▲/▼** arrow) buttons to select **3D**, and then press the **OK** button.
- 3 Press the (**▲/▼** arrow) buttons to select **3D Auto Start**.
- 4 Press the (**◀/▶** arrow) buttons to select **3D**, **2D**, or **Off**.

<i>Option:</i>	<i>Description:</i>
3D	Displays in 3D mode automatically when 3D format signal with 3D Auto Detect Information is received.
2D	Displays in 2D mode automatically when 3D format signal with 3D Auto Detect Information is received.
Off	Displays a screen that allows you to select 3D or 2D when 3D format signal with 3D Auto Detect Information is received.

Setting the 3D PIN code

A 3D PIN code is necessary for using 3D Safety Settings.

Enter a new PIN code

- 1 Press the **MENU** button.
- 2 Use the (**▲/▼** arrow) buttons to select **3D**, and then press the **OK** button.
- 3 Press the (**▲/▼** arrow) buttons to select **3D PIN**, and then press the **OK** button.
- 4 Press the number buttons to enter a 4-digit number, and then confirm the code.

NOTE the PIN code cannot be set to "0000."

Change or delete your PIN code

- 1 Press the **MENU** button.
 - 2 Use the (▲/▼ arrow) buttons to select **3D**, and then press the **OK** button.
 - 3 Press the (▲/▼ arrow) buttons to select **3D PIN**.
 - 4 Press the number buttons to enter your 4-digit PIN code.
 - 5 Select **Change PIN** or **Delete PIN**, and then press the **OK** button.
-

NOTE ❖ The PIN code cannot be set to "0000."
❖ If PIN is deleted, 3D Safety Settings are grayed out, and the settings are reset to the factory default.

Forgotten PIN codes

- 1 Press the **MENU** button.
- 2 Use the (▲/▼ arrow) buttons to select **3D**, and then press the **OK** button.
- 3 Press the (▲/▼ arrow) buttons to select **3D PIN**.
- 4 Press the **INFO** button 4 times within 5 seconds.
The code clears.
- 5 Enter a new PIN code.

Setting the 3D start message

When this feature is set to On, a message displays on the screen when a 3D signal is received.

- 1 Press the **MENU** button.
- 2 Use the (▲/▼ arrow) buttons to select **3D**, and then press the **OK** button.
- 3 Press the (▲/▼ arrow) buttons to select **3D Safety Settings**, and then press the **OK** button.
- 4 Enter your 4-digit 3D PIN code.
- 5 Press the (▲/▼ arrow) buttons to select **3D Start Message**.

- 6 Press the (◀/▶ arrow) buttons to select **On** or **Off**.

Setting the 3D Lock

When this feature is set to On, you must enter your 3D PIN code to change the display mode to 3D mode or 2D to 3D mode.

- 1 Press the **MENU** button.
- 2 Use the (▲/▼ arrow) buttons to select **3D**, and then press the **OK** button.
- 3 Press the (▲/▼ arrow) buttons to select **3D Safety Settings**, and then press the **OK** button.
- 4 Enter your 4-digit 3D PIN code.
- 5 Press the (▲/▼ arrow) buttons to select **3D Lock**.
- 6 Press the (◀/▶ arrow) buttons to select **On**.

Setting the 3D Timer Lock

When the 3D Timer Lock feature is set to On, the PIN input window and the 3D start message will not appear while the 3D Enable timer is active, even if you switch to 3D Mode. This prevents it from asking for the 3D Lock PIN, and will not display the 3D start message every you switch to 3D.

- 1 Press the **MENU** button.
- 2 Use the (▲/▼ arrow) buttons to select **3D**, and then press the **OK** button.
- 3 Press the (▲/▼ arrow) buttons to select **3D Safety Settings**, and then press the **OK** button.
- 4 Enter your 4-digit 3D PIN code.
- 5 Press the (▲/▼ arrow) buttons to select **3D Timer Lock**.
- 6 Press the (◀/▶ arrow) buttons to select **On**.

NOTE

The PIN input window appears when “continue” is selected in the reminder dialogue box for Enable 3D Timer even if 3D Timer Lock is activated.

Setting the Enable 3D Timer

This feature allows you to set a reminder to not watch a 3D video for an extended period of time. Once a set period of time has passed, a dialogue box appear asking if you wish to continue viewing.

- 1 Press the **MENU** button.
- 2 Use the (▲/▼ arrow) buttons to select **3D**, and then press the **OK** button.
- 3 Press the (▲/▼ arrow) buttons to select **3D Safety Settings**, and then press the **OK** button.
- 4 Enter your 4-digit 3D PIN code.
- 5 Press the (▲/▼ arrow) buttons to select **Enable 3D Timer**.
- 6 Press the (◀/▶ arrow) buttons to select **30, 60, 90, or 120** minutes.
- 7 To cancel the timer, select **Off**.

Displaying 3D Important Information

- 1 Press the **MENU** button.
- 2 Use the (▲/▼ arrow) buttons to select **3D**, and then press the **OK** button.
- 3 Press the (▲/▼ arrow) buttons to select **3D Important Info**, and then press the **OK** button.

Adjusting 2D to 3D depth

With this feature, you can adjust the level of 3D depth.

Within the Menu:

- 1 Press the **MENU** button.
- 2 Use the (▲/▼ arrow) buttons to select **3D**, and then press the **OK** button.
- 3 Press the (▲/▼ arrow) buttons to select **2D to 3D Depth**.
- 4 Press the (◀/▶ arrow) buttons to select either **1, 2, 3, 4, or 5**, and then press the **OK** button.

Within the Quick menu:

- 1 Press the **QUICK** button in 2D to 3D mode.
- 2 Press the (▲/▼ arrow) buttons to select **3D Settings**, and then press the **OK** button.
- 3 Press the (▲/▼ arrow) buttons to select **2D to 3D Depth**.
- 4 Press the (◀/▶ arrow) buttons to select either **1, 2, 3, 4, or 5**, and then press the **OK** button.

Switching left and right images

The left and right images of the glasses can be swapped. If 3D images look blurry, switch the left and right sides of the 3D image.

- 1 Press the **QUICK** button to open the Quick menu.
- 2 Press the (▲/▼ arrow) buttons to select **3D Settings**, and then press the **OK** button.
- 3 Press the (▲/▼ arrow) buttons to select **Left and Right Image**. Press the (◀/▶ arrow) buttons to select **Swapped**.

Tuning Channels

Tuning to the next programmed channel

Press the CH Up/Down arrow buttons on the remote control or TV control panel.

Tuning to a specific channel (programmed or unprogrammed)

<i>Channel:</i>	<i>Description:</i>
Analog	Use the 0–9 buttons on the remote control. (For example, to select channel 125, press 1, 2, 5.), and then press the OK button.
Digital	Use the 0–9 buttons on the remote control to enter the major channel number. Press the DASH button, (For example, to select digital channel 125- 1, press 1, 2, 5, -, 1.), and then press the OK button.

Using Channel Return

You can switch between two channels without entering a channel number each time. This feature also works for external inputs.

- 1 Select the first channel you want to view.
- 2 Select a second channel using the Channel Number buttons (and press the **DASH** button if needed).
- 3 Each time you press the **CH RTN** button, the TV switches between the last two channels that were tuned.

Using SurfLock™

The SurfLock™ feature temporarily programs one channel to the **CH RTN** button so that you can quickly return to it from any other channel. This feature also works for external inputs.

To temporarily program the **CH RTN** button with a particular channel:

- 1 Tune to the channel you wish to program to the **CH RTN** button.
- 2 Press and hold the **CH RTN** button for approximately 4 seconds until the message “Memorized” appears. The channel has been programmed to the **CH RTN** button.
- 3 You can then change channels repeatedly, and when you press the **CH RTN** button, the memorized channel is tuned to.

After pressing the **CH RTN** button and then changing channels again, the memory is cleared and the button functions as Channel Return.

Selecting the video input to view

To select the video input to view:

- 1 Press the **INPUT** button on the remote control or TV control panel.
- 2 Change the input:
 - ❖ Press 0–8.
 - ❖ Repeatedly press the (▲/▼ arrow) buttons, and then press the **OK** button.
 - ❖ Repeatedly press the **INPUT** button.

<i>Inputs</i>	
0	ANT/CABLE
1	Video 1
2	Video 2
3	ColorStream HD1
4	HDMI 1
5	HDM 2
6	HDM 3
7	HDM 4
8	PC

- NOTE
- ❖ You can label the video input sources according to the specific devices you have connected to the TV, see “Labeling video inputs” on page 70.
 - ❖ You can skip sources, see “Skipping video inputs” on page 68.
 - ❖ Inputs that are set to be skipped will be skipped when selecting by repeatedly pressing the **INPUT** button or the (▲/▼ arrow) buttons.
 - ❖ You can select inputs that are set to be skipped using the number buttons.
 - ❖ If one or more HDMI® CEC devices are connected to an HDMI® input, the icon appears in the input selector. In this case, the label, see “Labeling video inputs” on page 70 will not appear in the input selector.
-

To select an HDMI® CEC device:

- 1 Press the (▲/▼ arrow) buttons to select an HDMI® input.
- 2 Press the (▶ arrow) button. The list of HDMI® CEC devices for that input appears.
- 3 If the input has multiple HDMI® CEC devices, use the (▲/▼ arrow) buttons to select a device.
- 4 Press the **OK** button.

Using closed captions

To turn on the closed caption mode:

- 1 Press the **MENU** button. Select **SETTINGS, SETUP, TV Settings**, and then press the **OK** button.
 - 2 Press the (▲/▼ arrow) buttons to select **Closed Captions**, and then press the **OK** button.
 - 3 Press the (▲/▼ arrow) buttons to select **Closed Captions Display**.
 - 4 Press the (◀/▶ arrow) buttons to select **On** or **Off**.
-

- NOTE
- If Closed Captions Display is set to Off, Analog CC Mode and Digital CC Settings will be not available.
-

Analog CC mode

The closed caption mode has two options:

<i>Mode:</i>	<i>Description:</i>
Captions	Displays the dialogue, narration, and sound effects of TV programs and videos that are closed captioned (usually marked "CC" in program guides).
Text	Displays information not related to the current program, such as weather or stock data (when provided by individual stations).

To view captions or text:

- 1 Press the **MENU** button. Select **SETTINGS, SETUP, TV Settings**, and then press the **OK** button.
- 2 Press the (▲/▼ arrow) buttons to select **Closed Captions**, and then press the **OK** button.
- 3 Press the (▲/▼ arrow) buttons to select **Analog CC Mode**.

To view captions:

Press the (◀/▶ arrow) buttons to highlight **CC1, CC2, CC3, or CC4**.



(Sample Illustration) Captions

NOTE

If the program or video you have selected is not closed captioned, no captions will be displayed.

To view text:

Press the (◀/▶ arrow) buttons to highlight **T1**, **T2**, **T3**, or **T4**.

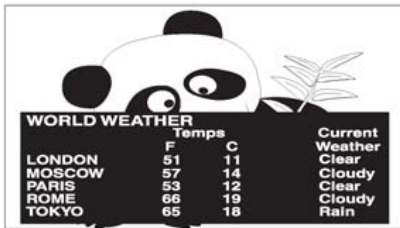

(Sample Illustration) Captions - text

NOTE

If text is not available in your area, a black rectangle may appear on the screen. You can remove this rectangle by setting Closed Captions Display to Off.

NOTE

A closed caption signal may not be displayed when a videotape is dubbed, signal reception is weak, or signal reception is non-standard.

Digital CC settings

You can customize the closed caption display characteristics.

NOTE

- ❖ These settings are available for digital channels only.
- ❖ You cannot set Caption Text and Background as the same color.

<i>Mode:</i>	<i>Description</i>
Caption size	Auto, Small, Standard, Large
Caption text type	Mono (with Serif), Prop. (with Serif), Mono (without Serif), Prop. (without Serif), Casual, Cursive, Small Capitals
Caption text edge	Auto, None, Raised, Depressed, Uniform, Left Drop Shadow, Right Drop Shadow
Caption text color	Auto, Black, White, Red, Green, Blue, Yellow, Magenta, Cyan
Text foreground opacity	Auto, Transparent, Translucent, Flashing, Solid
Background color	Auto, Black, White, Red, Green, Blue, Yellow, Magenta, Cyan

<i>Mode:</i>	<i>Description</i>
Text background opacity	Auto, Transparent, Translucent, Flashing, Solid
Caption text edge color	Auto, Black, White, Red, Green, Blue, Yellow, Magenta, Cyan

To customize the closed captions:

- 1 Press the **MENU** button. Select **SETTINGS, SETUP, TV Settings**, and then press the **OK** button.
- 2 Press the (**▲/▼** arrow) buttons to select **Closed Captions**, and then press the **OK** button.
- 3 Press the (**▲/▼** arrow) buttons to select **Digital CC Settings**, and then press the **OK** button.
- 4 Press the (**▲/▼** arrow) buttons to select a characteristic. Press the (**◀/▶** arrow) buttons to select the format for that characteristic.

Using the Closed Caption button

If you press the **CC** button when an analog channel is tuned or from an external input (480i signal from the video input):

- ❖ The CC bar will appear and will display the options, CC1-4, T1-4.

If you press the **CC** button when a digital channel is tuned:

- ❖ The CC bar will appear and will display the available caption options for that channel or service.

Setting the PIN code

A PIN code is necessary for some menus.

NOTE The Parental Control and Locks menu is grayed out if no PIN has been set.

Entering a new PIN code

- 1 Press the **MENU** button. Select **SETTINGS**, **PREFERENCES**, **Parental PIN**, and then press the **OK** button.
- 2 Use the number buttons to enter a 4-digit number, and then confirm the code.

NOTE The PIN code cannot be set to "0000".

Changing or deleting your PIN code

- 1 Press the **MENU** button. Select **SETTINGS**, **PREFERENCES**, **Parental PIN**, and then press the **OK** button.
- 2 Use the number buttons to enter your 4-digit PIN code.
- 3 Select **Change PIN** or **Delete PIN**, and then press the **OK** button.

NOTE

- ❖ The PIN code cannot be set to "0000".
- ❖ If you delete the PIN code, the settings of Parental Controls and Locks are reset.

Forgotten PIN code

- 1 Press the **MENU** button. Select **SETTINGS**, **PREFERENCES**, **Parental PIN**, and then press the **OK** button.
- 2 Press the **INFO** button 4 times within 5 seconds. The code is cleared.
- 3 Enter a new PIN code.

Using parental controls

Blocking TV programs and movies by rating (V-Chip)

Some TV programs and movies include signals that classify the content of the program (as unsuitable for younger viewers). The V-Chip feature in this TV detects the signals and blocks the programs according to the ratings you select.

NOTE The V-Chip feature in this TV supports the U.S. V-Chip system only.

- 1** Press the **MENU** button. Select **SETTINGS**, **PREFERENCES**, **Parental Control and Locks**, and then press the **OK** button.
- 2** Enter your 4-digit PIN code.
- 3** Press the (▲/▼ arrow) buttons to highlight **Enable Rating Blocking**.
- 4** Press the (◀/▶ arrow) buttons to select **On**.
- 5** Press the (▲/▼ arrow) buttons to select **Edit Rating Limits**, and then press the **OK** button.
The Edit Rating Limits screen appears.
- 6** Press the (▲/▼/◀/▶ arrow) buttons.
- 7** Press the **OK** button to select a level of blocking.

A box with an “X” indicates a rating that will be blocked. As you highlight a rating, the rating’s definition appears at the bottom of the screen.

NOTE This feature will not be available if no PIN code is set.

Downloading an additional rating system

An additional rating system may be available for use in selectively blocking TV programs and movies.

NOTE The currently tuned station must be receiving a digital signal before an additional rating system can be downloaded.

- 1** Press the **MENU** button. Select **SETTINGS**, **PREFERENCES**, **Parental Control and Locks**, and then press the **OK** button.
- 2** Enter your 4-digit PIN code. The Parental Control and Locks screen appears.
- 3** Press the (▲/▼ arrow) buttons to highlight **Enable Rating Blocking**.
- 4** Press the (◀/▶ arrow) buttons to select **On**.

- 5 Press the (▲/▼ arrow) buttons to select **Edit Rating Limits**, and then press the **OK** button.

The Edit Rating Limits screen appears.

- 6 Select **Alt RS**, and then press the **OK** button.

The Edit Alternate Ratings screen appears.

NOTE

- ❖ The Alt RS button is only available if an additional rating system is currently available.
- ❖ The download may take several minutes.
- ❖ The information displayed on the Alternate Ratings screen depends on the configuration of the additional rating system available at the time of download.

- 7 Press the (▲/▼/◀/▶ arrow) buttons.

- 8 Press the **OK** button to select the desired level of blocking. A box with an “X” indicates the rating that will be blocked.

NOTE

- ❖ You can only download the additional rating system once. You cannot download updates if they become available.
- ❖ The additional rating system is not designed, transmitted, or controlled by the TV or Toshiba, nor is the availability of an additional rating system determined or controlled by Toshiba. Similarly, the rating of programs in an additional rating system is not determined, transmitted, or controlled by the TV or Toshiba.
- ❖ The additional rating system is an evolving technology; therefore, availability, content, and format may vary.

Rating system

Independent rating system for broadcasters:

<i>Ratings:</i>	<i>Description and Content themes:</i>
TV-MA	Mature Audience Only (This program is specifically designed to be viewed by adults and therefore may be unsuitable for children under 17. L) Crude or indecent language S) Explicit sexual activity V) Graphic violence
TV-14	Parents Strongly Cautioned (This program contains some material that many parents would find unsuitable for children under 14 years of age.) D) Intensely suggestive dialogue L) Strong, coarse language S) Intense sexual situations V) Intense violence

<i>Ratings:</i>	<i>Description and Content themes:</i>
TV-PG	Parental Guidance Suggested (This program contains material parents may find unsuitable for younger children.) D) Some suggestive dialogue L) Infrequent coarse language S) Some sexual situations V) Moderate violence
TV-G	General Audience (Most parents would find this program suitable for all ages.)
TV-Y7, TV-Y7FV	Directed to Older Children (This program is designed for children age 7 and above. NOTE: Programs in which fantasy violence may be more intense or more combative than other programs in this category are designated TV-Y7FV.)
TV-Y	All Children (This program is designed to be appropriate for all children.)

Independent rating system for movies

<i>Ratings:</i>	<i>Description and Content themes:</i>
X	X-rated (For adults only)
NC-17	Not intended for anyone 17 and under
R	Restricted (Under 17 requires accompanying parent or adult)
PG-13	Parents Strongly Cautioned (Some material may be inappropriate for children under 13)
PG	Parents Strongly Cautioned (Some material may be inappropriate for children under 13)
G	General Audience (Appropriate for all ages)

Indication other than rating system

<i>Display:</i>	<i>Description:</i>
NONE	The program is rated None.
(No rating appears)	No rating information is provided.

NOTE

If you place an "X" in the box next to "Rated "None"", programs rated "None" or "Not Rated" will be blocked; Programs that do not provide any rating information will not be blocked.

Displaying ratings

To display the rating of the program you are watching, press the **INFO** button on the remote control.

Unlocking programs

If you try to tune to a program that exceeds the rating limits you have set, the TV will enter program lock mode and a warning message will appear on screen. Follow the instructions to temporarily unlock the program.

Locking specific channels

A channel that is configured as Locked cannot be viewed unless the PIN code is entered first, see “[Setting the PIN code](#)” on page 90.

- 1 Press the **MENU** button. Select **SETTINGS**, **SETUP**, **TV Settings**, and then press the **OK** button.
- 2 Press the (▲/▼ arrow) buttons to select **Channel Options**, and then press the **OK** button.

The list of channels appears.

Channel Options				
Ch.	Type	Label		
5-1	DTV		<input type="checkbox"/>	<input checked="" type="checkbox"/>
6	ATV		<input type="checkbox"/>	<input type="checkbox"/>
6-1	DTV		<input type="checkbox"/>	<input type="checkbox"/>
8	ATV		<input type="checkbox"/>	<input type="checkbox"/>
9	ATV		<input type="checkbox"/>	<input type="checkbox"/>
10	ATV		<input type="checkbox"/>	<input type="checkbox"/>
11	ATV		<input type="checkbox"/>	<input type="checkbox"/>
12	ATV		<input type="checkbox"/>	<input type="checkbox"/>

(Sample Illustration) Channel options

- 3 Press the (▶ arrow) button and then the (▲/▼ arrow) buttons to select a channel in the lock column, and then press the **OK** button.
- 4 You must enter your PIN code to lock channels.

NOTE If no PIN code has been set, a warning appears. See, “[Setting the PIN code](#)” on page 90.

- 5 The box is selected. To clear the selection, press the **OK** button.

Locking video inputs

You can lock video inputs and channels 3 and 4. You cannot view the input sources or channels until you unlock the inputs by entering the PIN code.

- 1 Press the **MENU** button. Select **SETTINGS**, **PREFERENCES**, **Parental Control and Locks**, and then press the **OK** button.
- 2 Enter your 4-digit PIN code.
- 3 Press the (**▲/▼** arrow) buttons to highlight **Input Lock**.
- 4 Press the (**◀/▶** arrow) buttons to select **Video**, **Video+**, or **Off**.

<i>Mode:</i>	<i>Description:</i>
Video	Locks Video 1, Video 2, ColorStream HD1, HDMI 1, HDMI 2, HDMI 3, HDMI 4, and PC.
Video+	Locks Video 1, Video 2, ColorStream HD1, HDMI 1, HDMI 2, HDMI 3, HDMI 4, PC, and channels 3 and 4. Select Video+ if you want to play video tapes via the ANT/CABLE input.
Off	Unlocks all video inputs and channels 3 and 4.

Setting a time limit for games

You can use the GameTimer[®] to set a time limit for playing a video game. When the time expires, the TV locks all external inputs.

- 1 Press the **MENU** button. Select **TIMERS**, **GameTimer**, and then press the **OK** button.
- 2 Enter your 4-digit PIN code.
- 3 Press the (**◀/▶** arrow) buttons to select **30**, **60**, **90**, or **120** minutes.
- 4 To cancel the timer, select **Off**.

To deactivate the Input Lock once the GameTimer[®] has activated it:

- ❖ Set the Input Lock to **Off**, see “Locking video inputs” on page 96.

- NOTE
- ❖ A message appears when 10 minutes, 3 minutes, and 1 minute are remaining.
 - ❖ If the TV loses power with time remaining, the TV will enter Input Lock mode when power is restored (as if the GameTimer had been activated). You must deactivate the Input Lock, see “Locking video inputs” on page 96.
-

Locking the control panel

You can lock the control panel to prevent your settings from being changed accidentally (by children, for example). When Panel Lock is set to **On**, none of the controls on the control panel operate except **POWER**.

- 1 Press the **MENU** button. Select **SETTINGS**, **PREFERENCES**, **Parental Control and Locks**, and then press the **OK** button.
 - 2 Enter your 4-digit PIN code.
 - 3 Press the (▲/▼ arrow) buttons to select **Panel Lock**.
 - 4 Press the (◀/▶ arrow) buttons to select **On**.
-

- NOTE
- When Panel Lock is set to On, “Panel Lock” appears on screen when the buttons on the TV control panel are pressed. If the **POWER** button is pressed, the TV turns off and you must use the remote control to turn it on.
-

To unlock the control panel:

- ❖ Select **Off** in Step 4 above.

Using HDMI® CEC Control

This feature uses CEC technology and allows you to control Toshiba HDMI® CEC compatible devices from the TV remote control via HDMI® connection.

When Enable HDMI® CEC Control in the HDMI® CEC Control Setup menu is set to **On**, the following HDMI® CEC Control functions are enabled.

To set HDMI® CEC Control Setup

- 1 Press the **MENU** button. Select **SETTINGS**, **PREFERENCES**, **HDMI® CEC Control Setup**, and then press the **OK** button.
- 2 Press the (**▲/▼** arrow) buttons to highlight **Enable HDMI CEC Control**.
- 3 Press the (**◀/▶** arrow) buttons to select **On**.







NOTE If you set Enable HDMI® CEC Control to Off, the other items under HDMI® CEC Control Setup will be grayed out.



- 4 Press the (**▲/▼** arrow) buttons to select an item. Press the (**▲/▶** arrow) buttons to select **On** or the desired mode:
 - ❖ TV Auto Power: **On/Off**
 - ❖ Auto Standby: **On/Off**
 - ❖ Amplifier Control: **On/Off**
 - ❖ Speaker Preference: **TV Speakers/Amplifier**

NOTE These functions depend on the connected devices.

Controlling HDMI® CEC playback devices

With your TV's remote control, you can control the connected HDMI® CEC playback device (DVD player, etc.) you are watching.

<i>Button:</i>	<i>Description:</i>
	Begins playback
	Stops playback
	Pauses the picture during play or record mode
	A short press fast-forwards, and a long press skips forward.
	A short press rewinds, and a long press skips backward.
	Fast forward
	Rewind/reverse

<i>Button:</i>	<i>Description:</i>
	Menu navigation, etc.
	Enters content with a menu
RED, GREEN, YELLOW, BLUE	Controls various operation
0–9 buttons	
Channel Up/Down	Changes to the next available channel up or down in the sequence

NOTE These functions depend on the connected devices.

HDMI® CEC Player Control menu functions

- 1 Press the **QUICK** button to open the Quick menu.
- 2 Select **HDMI® CEC Player Control**, and then press the **OK** button.
- 3 Press the () buttons to select the item you want to control, and then press the **OK** button.

<i>Item:</i>	<i>Description:</i>
Power	Turns the selected device On and Off
Root Menu	Accesses the selected device's top menu
Content Menu	Accesses the content list when the OK button is pressed
Setup Menu	Accesses the device's setup menu

- NOTE** These functions depend on the connected devices.
- The HDMI® CEC Player Control item is not available under the following conditions:
- ❖ A non-HDMI® input is selected
 - ❖ The Enable HDMI® CEC Control item is set to Off
 - ❖ The connected HDMI® CEC device is not a playback or recording device
-

HDMI® CEC Control input source selection

If an HDMI® CEC device with HDMI® switching capability (e.g. an amplifier) is connected to the HDMI® input, you can select another HDMI® CEC device that is connected to the master HDMI® device.

Use the **INPUT** button on the remote control or the control panel, see [“Learning about the remote control”](#) on page 49.

Adjusting the amplifier's audio

Using the TV's remote control, you can adjust or mute the sound volume of your amplifier.

- ❖ The **VOL (+ -)** buttons adjust the volume level.
 - ❖ The **MUTE** button turns off the sound.
- 1** Press the **MENU** button. Select **SETTINGS**, **PREFERENCES**, **HDMI® CEC Control Setup**, and then press the **OK** button.
 - 2** Press the (**▲/▼** arrow) buttons to highlight **Speaker Preference**.
 - 3** Press the (**◀/▶** arrow) buttons to select **Amplifier**.
-

- NOTE** Confirm that a connected HDMI® CEC device (such as DVD player, etc.) is selected for the Amplifier input source.
-

- NOTE**
- ❖ You can also use this function when the amplifier is connected to the TV's DIGITAL AUDIO OUT terminal (not HDMI® connection). Select a digital audio input mode on the amplifier.
 - ❖ These functions depend on the device connected.
-

Other HDMI® CEC Control functions

When Enable HDMI® CEC Control and all items in the HDMI® CEC Control Setup menu are set to On, the following functions will be enabled:

<i>Item:</i>	<i>Description:</i>
TV Auto Power	If a HDMI® CEC device is turned on, the TV turns on automatically.
Auto Standby	If the TV is turned off, it will send a message to turn off all of the HDMI® CEC devices connected to the TV.
Amplifier	If Amplifier Control is set to On, you can adjust the sound volume or turn off the sound using the remote control.
Speaker Preference	With this item, you can set your audio output preference to the TV speakers or the amplifier. When this item is set to Amplifier, the remote control can be used to adjust or mute the volume of the audio. This item will not be available and set to TV Speakers automatically unless a HDMI® CEC compatible audio receiver is connected.

NOTE

When you turn on the amplifier, change its input source, or adjust the sound volume, the sound will be output from the amplifier's speakers even if TV Speakers has been selected. Turn the TV off and on again to output the sound from the TV speakers.

Using the HDMI® RGB Range feature

<i>Item:</i>	<i>Description:</i>
RGB Range: Auto	Adjusts the RGB full range signal automatically. When Limited is selected, the RGB output signal is output in the range of 16 to 235. When Full is selected, the RGB output signal is output in the range of 0 to 255.

The RGB Range setting requires appropriate HDMI® source devices. If your HDMI® source device does not support this feature, the TV may not work properly when it is enabled.

NOTE If your HDMI® connection is capable of 1080p and/or your TV is capable of refresh rates greater than 60 Hz, you will need a High Speed HDMI® cable. Conventional HDMI®/DVI cables may not work properly with this mode.

Select the appropriate HDMI® input mode (**HDMI 1**, **HDMI 2**, **HDMI 3**, or **HDMI 4**):

- 1 Press the **MENU** button. Select **SETTINGS**, **PREFERENCES**, **AV Connection**, and then press the **OK** button.
- 2 Press the (▲/▼ arrow) buttons to select **HDMI RGB Range**, and then press the **OK** button.
- 3 Press the (◀/▶ arrow) buttons to select a setting.

Viewing the HDMI® signal information

- 1 Press the **MENU** button. Select **SETTINGS**, **PREFERENCES**, **HDMI Information Display**.
- 2 Press the (◀/▶ arrow) buttons to select **On**. Press the **INFO** button.

The normal banner and signal information banner appear.

-
- NOTE**
- ❖ The signal information banner will appear when this feature is set to On and you watch an HDMI® input.
 - ❖ If you press the INFO button when this feature is set to Off, only the normal banner will appear.
-

Using your computer with the TV

Adjusting the image

If the edges of the picture are hidden, readjust Horizontal Position and Vertical Position. If the picture is affected by interference, readjust Clock Phase and Sampling Clock.

- 1 Select **PC input mode**, see “[Selecting the video input to view](#)” on page 86.
- 2 Press the **MENU** button. Select **SETTINGS**, **PREFERENCES**, **Display Settings**, and then press the **OK** button.

- 3 Press the (▲/▼ arrow) buttons to select **PC Settings**, and then press the **OK** button.

NOTE If a computer is not connected or there is no PC input signal, this menu will not be available.

- 4 Press the (▲/▼ arrow) buttons to select an item.
- 5 Press the (◀/▶ arrow) buttons to make adjustments.

NOTE The screen is disrupted momentarily when adjusting the PC settings. This is not a sign of malfunction.

<i>Mode:</i>	<i>Description:</i>	<i>Adjustment Range</i>
Horizontal Position	Moves the picture left/right	Within ± 10 from center*
Vertical Position	Moves the picture up/down	Within ± 10 from center*
Clock Phase	Helps to reduce noise and sharpen the picture	Within ± 15 from center*
Sampling Clocks	Helps to reduce noise and minimize periodic vertical stripes on the screen	Within ± 5 from center*

* The default settings and/or adjustment ranges vary depending on the input signal format.

To reset the PC Settings:

Select **Reset**, and then press the **OK** button.

Setting the computer audio

You can output sound from your computer when connecting it to your TV, using the AUDIO IN terminal and PC audio cable.

- 1 Press the **MENU** button. Select **SETTINGS**, **PREFERENCES**, **AV Connection**, and then press the **OK** button.
- 2 Press the (▲/▼ arrow) buttons to select **PC/HDMI 4 Audio**.
- 3 Press the (◀/▶ arrow) buttons to select **PC**.

NOTE To select PC, set Shared PC Audio to PC.

Setting the timer to turn on the TV

You can set the on timer to turn on the TV to a preset channel or input at a preset time.

To activate the timer:

- 1 Press the **MENU** button. Select **TIMERS, On Timer**, and then press the **OK** button.
- 2 Press the (**▲/▼** arrow) buttons to select **Enable On Timer**.
- 3 Press the (**◀/▶** arrow) buttons to select **On**.

NOTE If the Enable On Timer is set to Off, other menus under On Timer cannot be changed.
It can take the TV approximately 60 seconds to turn on through the ON TIMER feature.

To set the timer:

- 1 Press the **MENU** button. Select **TIMERS, On Timer**, and then press the **OK** button.
- 2 Set these options to your preference:

<i>Item:</i>	<i>Description:</i>
Input	Video input source
Channel	Channel to view
Volume	Volume level
Time until Power On	Desired length of time until the TV turns on: minimum=00:10, maximum=12:00 Press the (◀/▶ arrow) buttons Use the number buttons

- 3 Select **Done**, and then press the **OK** button.

NOTE If you do not operate the TV for 1 hour after it is powered on by the On Timer feature, it turns off.

To cancel the timer:

- 1 Press the **MENU** button. Select **TIMERS, On Timer**, and then press the **OK** button.

- 2 Press the (▲/▼ arrow) buttons to select **Enable On Timer**.
- 3 Press the (◀/▶ arrow) buttons to select **Off**.

Setting the sleep timer

You can set the TV to turn off after a specific amount of time (maximum = 12 hours).

Using the remote control:

- 1 Press the **SLEEP** button.
- 2 Set the amount of time until the TV turns off.
 - ❖ Repeatedly press the **SLEEP** button to increase the time.
 - ❖ Press the (▲/▼ arrow) buttons to increase or decrease the time.

Using the onscreen menus:

- 1 Press the **MENU** button. Select **TIMERS**, **Sleep Timer**, and then press the **OK** button.
- 2 Select the amount of time until the TV turns off.
 - ❖ Use the number buttons.
 - ❖ Press the (▲/▼ arrow) buttons to increase or decrease the time.

NOTE If a power failure occurs, the sleep timer setting may be cleared.

To display the time remaining until the TV turns off, press the **SLEEP** button.

To cancel the sleep timer, press the **SLEEP** button repeatedly or press the (▲/▼ arrow) buttons until it is set to 0 minutes.

NOTE When the following features are set, the feature that is set for the nearest time will function.

- ❖ Sleep Timer
 - ❖ Auto shutdown after 1 hour of inactivity (after powering on by On Timer)
 - ❖ No signal auto power off (after 15 minutes of no signal)
-

Setting No Signal Power Down

When an input's setting in this feature is set to On, The TV will automatically turn itself off after 15 minutes if no signal is detected.

You can change each input's setting to Off: ANT/CABLE, Video 1, Video 2, ColorStream HD1, ColorStream HD2, HDMI 1, HDMI 2, HDMI 3, HDMI 4, or PC.

- 1 Press the **MENU** button. Select **SETTINGS**, **PREFERENCES**, **Power Management**, and then press the **OK** button.
 - 2 Press the (**▲/▼** arrow) buttons to select **No Signal Power Down**, and then press the **OK** button.
 - 3 Press the (**▲/▼** arrow) buttons to highlight the item you want to change.
 - 4 Press the (**◀/▶** arrow) buttons to select **On** or **Off**. Press the **EXIT** button.
-

NOTE

- ❖ Default setting for each input is On.
 - ❖ A warning message will appear 1 minute before turning off.
-

Displaying TV status information

To display TV status information, press the **INFO** button.

The following information will be displayed (if applicable):

- ❖ Current input (**ANT/CABLE**, **Video**, etc.)
- ❖ Either “**CABLE**” (for cable TV) or “**ANT**” (for over-the-air broadcasts), if **ANT/CABLE** is the current input
- ❖ Channel number (if in **ANT/CABLE** mode)
- ❖ Input label (if set)
- ❖ Digital signal strength indicator (bar graph in lower right corner of box; for ATSC signals only)
- ❖ Stereo, Mono, or SAP audio status (when in **HDMI**[®] input mode, **PCM**)
- ❖ Video resolution
- ❖ Aspect ratio of incoming video signal (4:3 or 16:9)
- ❖ V-Chip rating status (if available)
- ❖ GameTimer (if set)

- ❖ Channel Label (if set or received)
- ❖ Current display mode (Side by Side, Top and Bottom, or Frame Packing)
- ❖ Current display format (2D to 3D, or 3D to 2D)
- ❖ Input video format (3D appears when video format is 3D)

To close the screen, press the **INFO** button again.

The following additional information (only available for ANT/CABLE input) will display for off-air digital channels (if applicable):

- ❖ Title
- ❖ Duration
- ❖ Detailed description

To display the next program's information for digital channels, press the **INFO** button again. Pressing the **INFO** button a third time will remove the entire banner.



(Sample Illustration) Banner

Viewing support information

- 1 Press the **MENU** button. Select **GET HELP, System Information**.
- 2 Press the **OK** button to display support information containing Web/Customer service numbers for US, Canada, and Mexico.

Resetting to Factory Defaults

You can reset all settings and channels.

- 1 Press the **MENU** button. Select **SETTINGS, SETUP, Reset TV**, and then press the **OK** button.
- 2 Enter your PIN code (if a PIN code has been set).
- 3 A confirmation screen appears. Select **Yes**, and then press the **OK** button.

The TV will turn off automatically.

To cancel the reset:

- ❖ Press the (◀/▶ arrow) buttons to select **No**, and then press the **OK** button.

Power failure

If power is lost while you are watching the TV, the Last Mode Memory feature automatically turns on the TV when power is restored.

Chapter 7

Picture and Sound Controls

Selecting the picture size

You can view many program formats in several picture sizes—Native, 4:3, Full, TheaterWide 1, TheaterWide 2, TheaterWide 3, Normal, and Dot by Dot.

NOTE The picture size illustrations are examples only. The format of the image (in any of the picture sizes) depends on the format of the signal you are currently watching. Select the picture size that displays the current program in the way that looks best to you.

You can save separate picture size preferences for each input on your TV.

To select the picture size:

- 1 Press the **PIC SIZE** button.
- 2 While the Picture Size screen is open, repeatedly press the **PIC SIZE** button.

- NOTE
- ❖ Using these functions to change the picture size (i.e., changing the height/width ratio) for any purpose other than your private viewing may be prohibited under the Copyright Laws of the United States and other countries, and may subject you to civil and criminal liability.
 - ❖ There will be restrictions on the Picture Size settings for 2D to 3D mode, 3D mode, and 2D mode.
 - ❖ Some picture sizes may not be available depending on the format of the signal being received.
 - ❖ If you select a TheaterWide® picture size, the top and bottom edges of the picture (including subtitles or captions) may be hidden. To view these edges, adjust the Picture Position or try viewing the program in 4:3 or Full, see [“Scrolling the picture” on page 113](#).

Native

These settings are for viewing in 480i (HDMI®), 480p (HDMI®), 720p, 1080i, and 1080p signal programs).

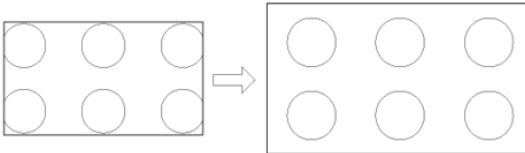

(Sample Illustration) Picture size - Native

- ❖ If receiving a 1080i, 1080p, 720p, 480i (HDMI®), or 480p (HDMI®) signal program, the video is scaled to display the entire picture within the borders of the screen (i.e. no overscanning).
- ❖ This is especially useful for external HD sources such as DVHS movies, Video Games, or computer graphics.
- ❖ None of the picture is hidden.

- NOTE
- ❖ This mode is supported only for HDMI® (1080i, 1080p, 720p, 480i, and 480p), ColorStream® (1080i and 720p), and ANT/CABLE (digital) inputs (1080i, 1080p, and 720p).
 - ❖ Depending on the input signal, the picture's border may be hidden, displayed in black, or noisy.

4:3

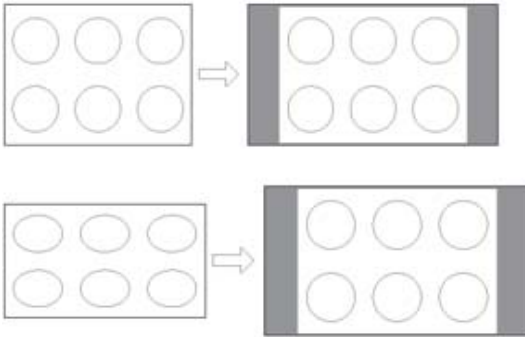

(Sample Illustration) Picture size - 4:3

Some program formats will display with sidebars and/or bars at the top and bottom.

Full

This setting is for viewing in the 16:9 (480i, 480p) source programs only.

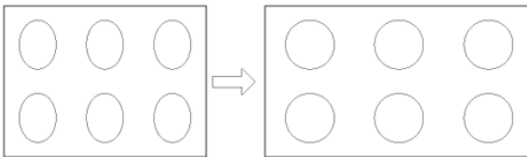

(Sample Illustration) Picture size - Full 16:9

If receiving a squeezed 4:3 format program, the picture is stretched horizontally to fill the width of the screen but not stretched vertically.

This setting is for viewing in the 1080i, 1080p, and 720p program source.

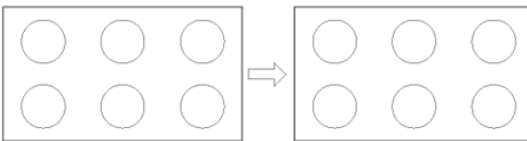

(Sample Illustration) Picture size - Full

The edges of the picture may be hidden.

TheaterWide 1

This setting is for viewing in 4:3 format programs.

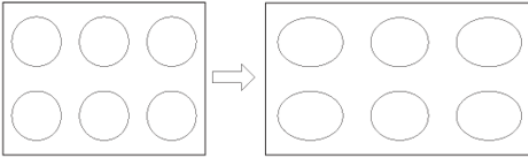

(Sample Illustration) Picture size - TheaterWide 1

The center of the picture remains close to its original proportions, but the left and right edges are stretched horizontally to fill the screen.

TheaterWide 2

This setting is for viewing letter box programs.

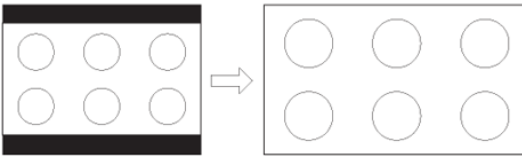

(Sample Illustration) Picture size - TheaterWide 2, letter box

The picture's top and bottom edges may be hidden*.

TheaterWide 3

This setting is for viewing letter box programs with subtitles.

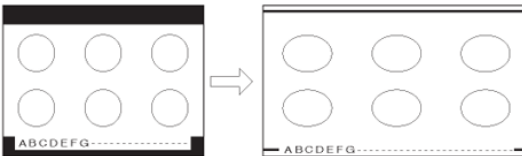

(Sample Illustration) Picture size - TheaterWide 3, letter box with subtitles

The picture's top and bottom edges are hidden*.

Normal

This setting is for viewing SVGA, XGA, WXGA, and SXGA sources.

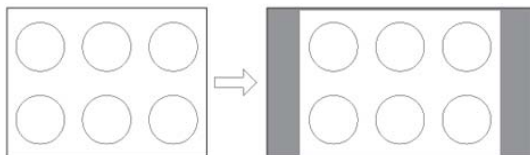

(Sample Illustration) Picture size - Normal

This size is a non-stretched display. Some input signal formats will display with sidebars and/or bars at the top and bottom.

Dot by Dot

This setting is for viewing SVGA, XGA, WXGA, and SXGA sources.

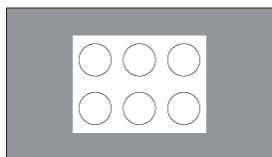

(Sample Illustration) Picture size - Dot by Dot

“Dot by Dot” is a non-scaling display. Depending on the input signal format, the picture appears with sidebars and/or bars at the top and bottom, for example, SVGA input source).

* To view the hidden areas (such as subtitles or captions), see “Scrolling the picture” on page 113.

Scrolling the picture

If the edges of the picture are hidden, you can adjust the image’s position.

NOTE

- ❖ You can adjust the picture position when the picture size is set to TheaterWide 2 or TheaterWide 3.
- ❖ When viewing ePORTAL, MediaShare (Media Player), or Internet content this feature is not available.

- 1 Press the **MENU** button. Select **SETTINGS**, **PREFERENCES**, **Display Settings**, and then press the **OK** button.

- 2 Press the (▲/▼ arrow) buttons to select **Picture Position**, and then press the **OK** button.
- 3 Press the (▲/▼ arrow) buttons to select **Vertical Position**.
- 4 Press the (◀/▶ arrow) buttons to make the appropriate adjustments.

The adjustment range is from **-5** to **+10**.

Using the Auto Aspect feature

When this feature is set to On, the TV will automatically select the picture size when one of the following input sources is received:

- ❖ 480i, 480p, 720p, 1080i digital signal from the ANT/CABLE input
- ❖ 480i signal from the ColorStream HD or Video input
- ❖ 480i, 480p, 720p, 1080i, 1080p, or VGA (60/72/75 Hz) signal from the HDMI[®] 1/2/3/4 input

NOTE The auto aspect ratio feature is not applicable to the PC input.

- 1 Press the **MENU** button. Select **SETTINGS**, **PREFERENCES**, **Display Settings**, and then press the **OK** button.
- 2 Press the (▲/▼ arrow) buttons to select **Auto Aspect**.
- 3 Press the (◀/▶ arrow) buttons to select **On**. Press the **EXIT** button.

Using the 4:3 Stretch

When 4:3 Stretch is activated, the TV displays 4:3 programs as a full-screen picture.

NOTE This feature is available when Auto Aspect is set to On.

- 1 Press the **MENU** button. Select **SETTINGS**, **PREFERENCES**, **Display Settings**, and then press the **OK** button.
- 2 Press the (▲/▼ arrow) buttons to select **4:3 Stretch**.
- 3 Press the (◀/▶ arrow) buttons to select **On**. Press the **EXIT** button.

Adjusting the picture

Selecting the picture mode

You can select your desired picture settings from the modes described below.

<i>Mode:</i>	<i>Description:</i>
AutoView®	Automatically adjusts picture settings based on ambient light conditions and input signal content
Dynamic	Bright and dynamic picture
Standard	Standard picture settings
Movie	Lower contrast for a darkened room
Game	Designed for playing a video game requiring split-second timing between the screen display and input from the controller
PC	Designed for the viewing of computer tables and documents

NOTE PC mode is available for HDMI® and PC inputs only (not displayed for other input sources).

- 1 Press the **MENU** button. Select **SETTINGS, PICTURE, Picture Mode**.
- 2 Press the (◀/▶ arrow) buttons to select a mode. Press the **EXIT** button.

NOTE The picture mode you select affects the current input only. You can select a different picture mode for each input.

Adjusting the picture quality

The adjustments you make to picture quality under a picture mode are saved to that picture mode.

<i>Selection</i>	<i>Pressing (◀)</i>	<i>Pressing (▶)</i>
Backlight*	Darker	Lighter
Contrast	Lower	Higher

<i>Selection</i>	<i>Pressing (◀)</i>	<i>Pressing (▶)</i>
Brightness	Darker	Lighter
Color	Paler	Deeper
Tint	Reddish	Greenish
Sharpness	Softer	Sharper

* **Backlight:** Adjusts the brightness of the entire screen. When in video mode and no signal is input, this selection is set to 0. (Settings are stored in memory.)

NOTE Some settings cannot be adjusted in the following cases:

- ❖ AutoView is selected
- ❖ TheaterLock is set to On

To adjust the picture quality:

- 1** Press the **MENU** button. Select **SETTINGS, PICTURE**, the setting you would like to adjust (Backlight, Contrast, Brightness, Color, Tint, or Sharpness).
- 2** Press the (◀/▶ arrow) buttons to adjust the setting. Press the **EXIT** button.

NOTE

- ❖ Any picture settings that you adjust affect the current input only. You can adjust the picture quality separately for each input.
- ❖ Depending on a Sharpness value, the Edge Enhancer effect may be reduced.

To reset to the factory defaults:

- 1** Select the picture mode you want to reset.
- 2** Press the **MENU** button. Select **SETTINGS, PICTURE, Reset**, and then press the **OK** button.
A confirmation screen appears.
- 3** Press the (◀/▶ arrow) buttons to select **Yes**, and then press the **OK** button.

Using the advanced picture settings features

NOTE Some of the Advanced Picture Settings features will not be available for adjustment when the Picture Mode is set to AutoView.

Edge Enhancer

The Edge Enhancer feature lets you adjust the levels for your desired picture settings and achieve a sharper picture.

To set Edge Enhancer:

- 1 Press the **MENU** button. Select **SETTINGS, PICTURE, Advanced Picture Settings**, and then press the **OK** button.
- 2 Press the (▲/▼ arrow) buttons to select **Edge Enhancer**, and then press the **OK** button.
- 3 Press the (◀/▶ arrow) buttons to select **On**.
- 4 Press the (▲/▼ arrow) buttons to highlight **Level**. Press the (◀/▶ arrow) buttons to select either **1, 2, 3, 4, or 5**. Press the **EXIT** button.

NOTE

- ❖ When the Picture Mode is set to AutoView, the level range is from -2 to +2.
- ❖ If the Picture Mode is set to Game or PC, Edge Enhancer is not available.
- ❖ This feature may not work properly depending on the content.
- ❖ Noise may appear on the image depending on the device connected to the TV (e.g. a device with a specific enhancer function).

Dynamic Contrast

Dynamic Contrast detects changes in picture quality that affect the appearance of your contrast settings and then automatically adjusts the video.

- 1 Press the **MENU** button. Select **SETTINGS, PICTURE, Advanced Picture Settings**, and then press the **OK** button.
- 2 Press the (▲/▼ arrow) buttons to select **Dynamic Contrast**.
- 3 Press the (◀/▶ arrow) buttons to adjust the level. The adjustment range is from 0 to 10. Press the **EXIT** button.

NOTE When the Picture Mode is set to AutoView, the level range is from -5 to +5.

DynaLight®

The DynaLight® feature automatically strengthens the black coloring of dark areas in the video according to the level of darkness.

- 1 Press the **MENU** button. Select **SETTINGS, PICTURE, Advanced Picture Settings**, and then press the **OK** button.
- 2 Press the (**▲/▼** arrow) buttons to select **DynaLight**.
- 3 Press the (**◀/▶** arrow) buttons to select **Off/Low/Middle/High**. Press the **EXIT** button.

Static Gamma

The static gamma feature lets you adjust the levels of black in the picture.

To adjust the static gamma settings:

- 1 Press the **MENU** button. Select **SETTINGS, PICTURE, Advanced Picture Settings**, and then press the **OK** button.
- 2 Press the (**▲/▼** arrow) buttons to select **Static Gamma**.
- 3 Press the (**◀/▶** arrow) buttons to adjust the level. The adjustment range is within ± 15 from center. Press the **EXIT** button.

ClearScan®

This feature helps to eliminate video shaking.

- 1 Press the **MENU** button. Select **SETTINGS, PICTURE, Advanced Picture Settings**, and then press the **OK** button.
- 2 Press the (**▲/▼** arrow) buttons to select **ClearScan**.
- 3 Press the (**◀/▶** arrow) buttons to select **Cinema, Smooth, Standard**, or **Off**. Press the **EXIT** button.

NOTE ClearScan® is for the L7200U model and Cinema Mode is for the L6200U model.

If the picture mode is set to Game or PC mode, this feature is automatically not available.

Cinema Mode

This feature provides smoother motion and a crisper image.

- 1 Press the **MENU** button. Select **SETTINGS, PICTURE, Advanced Picture Settings**, and then press the **OK** button.
- 2 Press the (**▲/▼** arrow) buttons to select **Cinema Mode**.
- 3 Press the (**◀/▶** arrow) buttons to select **On** or **Off**. Press the **EXIT** button.

NOTE

If the Picture Mode is set to Game or PC mode, this feature is automatically set and is not available.

MPEG NR

The MPEG noise reduction feature allows you to reduce visible interference caused by MPEG compression.

- 1 Press the **MENU** button. Select **SETTINGS, PICTURE, Advanced Picture Settings**, and then press the **OK** button.
- 2 Press the (**▲/▼** arrow) buttons to select **Noise Reduction**, and then press the **OK** button.
- 3 Press the (**▲/▼** arrow) buttons to highlight **MPEG NR**.
- 4 Press the (**◀/▶** arrow) buttons to select either **Low, Middle, High**, or **Off**. Press the **EXIT** button.

NOTE

If the Picture Mode is set to Game or PC, this feature is not available.

DNR

DNR allows you to soften the screen representation of a weak signal to reduce the noise effect.

- 1 Press the **MENU** button. Select **SETTINGS, PICTURE, Advanced Picture Settings**, and then press the **OK** button.
- 2 Press the (**▲/▼** arrow) buttons to select **Noise Reduction**, and then press the **OK** button.
- 3 Press the (**▲/▼** arrow) buttons to select **DNR**.
- 4 Press the (**◀/▶** arrow) buttons to select **Low, Middle, High, Auto**, or **Off**. Press the **EXIT** button.

-
- NOTE** The differences may not always be noticeable. For the best results, use lower settings, as picture quality may be greatly reduced if the setting is too high.
- If the picture mode is set to Game or PC, this feature is not available.
-

Auto Brightness Sensor

When the Auto Brightness function of Auto Brightness Sensor is set to On, the TV optimizes the backlighting levels to suit ambient light conditions.

- 1 Press the **MENU** button. Select **SETTINGS, PICTURE, Advanced Picture Settings**, and then press the **OK** button.
- 2 Press the (▲/▼ arrow) buttons to select **Auto Brightness Sensor Settings**, and then press the **OK** button.
- 3 Press the (▲/▼ arrow) buttons to select **Auto Brightness Sensor**.
- 4 Press the (◀/▶ arrow) buttons to select **On** or **Off**. Press the **EXIT** button.

-
- NOTE** When the Picture Mode is set to AutoView, this feature is automatically set to On.
-

Backlight Adjustment Pro

This feature adjusts the backlight so that it can change to match the ambient light conditions.

- 1 Press the **MENU** button. Select **SETTINGS, PICTURE, Advanced Picture Settings**, and then press the **OK** button.
- 2 Press the (▲/▼ arrow) buttons to select **Auto Brightness Sensor Settings**, and then press the **OK** button.
- 3 Press the (▲/▼ arrow) buttons to select **Backlight Adjustment Pro**, and then press the **OK** button.
The Backlight Control Level screen appears.
- 4 Press the **OK** button to display the adjustment window.
- 5 Press the (◀/▶ arrow) buttons to select the point.

- 6 Press the (▲/▼ arrow) buttons to adjust the level.
The adjustment range is from 0 to 100.

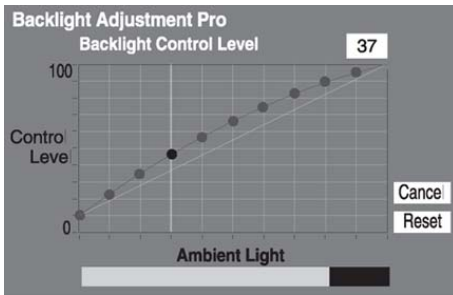

(Sample Illustration) Backlight adjustment window

- 7 Press the **OK** button to fix the adjustment.
- ❖ To cancel the adjustment when selecting a point, select **Cancel** on the screen.
 - ❖ To reset the adjustments of all points to the factory defaults, select **Reset** on the screen, and then press the **OK** button.

NOTE If the Auto Brightness Sensor is set to Off, this feature will not be available.

ColorMaster™

The ColorMaster™ feature allows you to adjust standard colors.

- 1 Press the **MENU** button. Select **SETTINGS, PICTURE, Advanced Picture Settings**, and then press the **OK** button.
- 2 Press the (▲/▼ arrow) buttons to select **ColorMaster**, press the (◀/▶ arrow) buttons to select **On**. Press the **EXIT** button.

Base Color Adjustment

When ColorMaster™ is set to On, the list of base colors appears. You can select a base color to adjust.

- 1 Press the **MENU** button. Select **SETTINGS, PICTURE, Advanced Picture Settings**, and then press the **OK** button.
- 2 Press the (▲/▼ arrow) buttons to select **Base Color Adjustment**, and then press the **OK** button.

The Base Color Adjustment screen appears.

- 3 Press the (▲/▼ arrow) buttons to select a color. Press the (▶ arrow) button.
- 4 Press the (◀/▶ arrow) buttons to select **Hue, Saturation, or Brightness**.
- 5 Press the (▲/▼ arrow) buttons to adjust the setting.
- 6 Repeat Steps 3 through 5 to adjust other colors. To reset the adjustments to the factory defaults, select **Reset** on the screen, and then press the **OK** button.

Color temperature

- 1 Press the **MENU** button. Select **SETTINGS, PICTURE, Advanced Picture Settings**, and then press the **OK** button.
- 2 Press the (▲/▼ arrow) buttons to select **Color Temperature**.
- 3 Press the (◀/▶ arrow) buttons to adjust the level. The adjustment range is 0 (warm) to 10 (cool). Press the **EXIT** button.

NOTE When the Picture Mode is set to AutoView, the adjustment range is -5 to +5.

Resetting to the factory default

- 1 Press the **MENU** button. Select **SETTINGS, PICTURE, Advanced Picture Settings**, and then press the **OK** button.
- 2 Press the (▲/▼ arrow) buttons to select **Reset**, and then press the **OK** button.
A confirmation screen appears.
- 3 Select **Yes**, and then press the **OK** button.

Setting the expert picture settings

Test Pattern

When the test pattern is on screen, you can navigate the Picture submenus without removing the image. When you move to a non-Picture menu, or close the menus, regular video will be restored.

- 1 Press the **MENU** button. Select **SETTINGS, PICTURE, Expert Picture Settings**, and then press the **OK** button.
- 2 Select **Test Pattern**.

- 3 Press the (◀/▶ arrow) buttons to select **On**.
- 4 Adjust picture settings.

NOTE When the TV is in 3D mode, this feature is not available.

RGB Filter

This feature individually enables or disables the red, green, and blue components of the picture to allow for more accurate adjustment of each color.

- 1 Press the **MENU** button. Select **SETTINGS, PICTURE, Expert Picture Settings**, and then press the **OK** button.
- 2 Press the (▲/▼ arrow) buttons to select **RGB Filter**, and then press the **OK** button.
- 3 Press the (▲/▼ arrow) buttons to select **Red, Green, or Blue** to adjust.
- 4 Press the (◀/▶ arrow) buttons to select **On**.
- 5 Press the (▼ arrow) button to select **Color** or **Tint**, press the (◀/▶ arrow) buttons to adjust. Press the **EXIT** button.

NOTE It is not possible to turn off all three colors simultaneously.

White Balance

Window Display

This feature displays the Window Pattern to adjust the white balance with a measuring device.

- 1 Press the **MENU** button. Select **SETTINGS, PICTURE, Expert Picture Settings**, and then press the **OK** button.
- 2 Press the (▲/▼ arrow) buttons to select **White Balance**, and then press the **OK** button.
- 3 Press the (▲/▼ arrow) buttons to select **Window Display**.
- 4 Press the (◀/▶ arrow) buttons to select **On**.
- 5 Adjust the picture settings.

Setting Type

You can adjust the white balance setting.

- 1 Press the **MENU** button. Select **SETTINGS, PICTURE, Expert Picture Settings**, and then press the **OK** button.
- 2 Press the (**▲/▼** arrow) buttons to select **White Balance**, and then press the **OK** button.
- 3 Press the (**▲/▼** arrow) buttons to select **2P White Balance**, and then press the **OK** button.
- 4 Press the (**▲/▼** arrow) buttons to select **Red-Offset, Green-Offset, Blue-Offset, Red-Gain, Green-Gain, or Blue-Gain**.
- 5 Press the (**◀/▶** arrow) buttons to adjust.

Copy to All Inputs

This feature copies White Balance on the current input to all other inputs. Individual settings that are not allowed for a specific input will not be copied.

- 1 Press the **MENU** button. Select **SETTINGS, PICTURE, Expert Picture Settings**, and then press the **OK** button.
- 2 Press the (**▲/▼** arrow) buttons to select **White Balance**, and then press the **OK** button.
- 3 Press the (**▲/▼** arrow) buttons to select **Copy to All Inputs**, and then press the **OK** button.
A confirmation screen appears.
- 4 Select **Yes**, and then press the **OK** button.

Locking the picture settings

The TheaterLock™ feature lets you lock items in the PICTURE menu that affect the picture's display. These items cannot be modified when TheaterLock is set to On.

- 1 Press the **MENU** button. Select **SETTINGS, PICTURE, TheaterLock**.
- 2 Press the (**◀/▶** arrow) buttons to select **On**. Press the **EXIT** button.

Adjusting the audio

Muting the sound

Press the **MUTE** button to partially reduce (1/2 Mute) or turn off (Mute) the sound. Each time you press the **MUTE** button, the mute mode changes in the following order: 1/2 Mute, Mute, Volume, 1/2 Mute, etc.

If the closed caption mode is set to **Off** when you select **MUTE** mode, the closed caption feature becomes active if the TV program is closed captioned. To mute the audio without activating the closed captioning, press the **VOL (-)** button to set the volume to 0.

NOTE If you modify items in the **SOUND** menu while Mute is active, Mute is cancelled.

Selecting stereo/SAP broadcasts

The MTS (multi-channel TV sound) feature is only available for analog signals on the ANT/CABLE input. When the TV receives a stereo or SAP (second audio program) broadcast, the icon **STEREO** or **SAP** appears on screen when the **INFO** button is pressed.

To listen in stereo sound:

- 1 Press the **MENU** button. Select **SETTINGS, SOUND**, and then **MTS**.
- 2 Press the (◀/▶ arrow) buttons to select **Stereo**, and then press the **EXIT** button.

NOTE

- ❖ You can typically leave the TV in Stereo mode because it outputs the type of sound being broadcast (stereo or monaural).
- ❖ If the sound is noisy, select Mono.
- ❖ If there is no sound in SAP mode, select Stereo.

Adjusting the audio balance

You can adjust the audio balance.

- 1 Press the **MENU** button. Select **SETTINGS, SOUND**, and then **Balance**.
- 2 Press the (◀/▶ arrow) buttons to adjust the balance, and then press the **EXIT** button.

Adjusting the range

You can adjust bass and treble.

- 1 Press the **MENU** button. Select **SETTINGS**, **SOUND**, and then **Bass** or **Treble**.
- 2 Press the (◀/▶ arrow) buttons to adjust the range, and then press the **EXIT** button.

Selecting the optical audio output format

You can select the optical audio output format when you connect a Dolby® Digital decoder or other digital audio systems to the TV's DIGITAL AUDIO OUT terminal.

- 1 Tune to a digital source on the **ANT/CABLE** input.
- 2 Press the **MENU** button. Select **SETTINGS**, **PREFERENCES**, **AV Connection**, and then press the **OK** button.
- 3 Press the (▲/▼ arrow) buttons to select **Digital Audio Output**.
- 4 Press the (◀/▶ arrow) buttons to select **Auto** or **PCM**. Press the **EXIT** button.

Using the Dolby® Digital Dynamic Range Control feature

You can further compress Dolby® Digital and Dolby® Digital Plus dynamic range so you can switch from digital to analog broadcasts at the same dynamic range.

- 1 Press the **MENU** button. Select **SETTINGS**, **SOUND**, and then **Dynamic Range Control**.
- 2 Press the (◀/▶ arrow) buttons to select **On**.

NOTE

This feature is available when Dolby® Digital or Dolby® Digital Plus is input to the TV in the following situations:

- ❖ When tuned to a digital RF channel
- ❖ When an HDMI® input is used

This feature is automatically set to Off when Dynamic Volume (Audyssey Dynamic Volume®) is set to Low or High.

This feature will also affect Digital Audio Output when the optical audio output format is set to PCM.

Audyssey Premium Television™

These televisions use a suite of technologies for better sound including:

- ❖ Audyssey EQ®—provides clear, accurate and natural sound right out of the box. This technology ensures you enjoy your audio experience as much as your video.
- ❖ Audyssey ABX™—technology uses sophisticated driver analysis and low frequency monitoring to extend the range and bass of small speakers. This enables the system to produce lower frequencies than would be possible with a traditional system of the same size.
- ❖ Audyssey Dynamic Volume®—automatically adjusts volume to provide a consistent sound level between television programs, commercials, and between the loud and soft passages of movies.
- ❖ Audyssey Volume Extension®—doubles the volume capability in small speakers while blocking distortion so your TV gets loud and still sound great.
- ❖ Day/Night Modes—automatically keep the volume of the TV at the perfect level for day or night.
- ❖ Wall/Table Modes—automatically keep the volume at the perfect level for television mounted on a wall or located on a table-top.

Using Audyssey EQ® for Wall Mounted or Table-top TVs

This feature automatically keep the volume at the perfect level for television mounted on a wall or located on a table-top.

- 1 Press the **MENU** button. Select **SETTINGS, SOUND, Audyssey Premium Television, TV Mounting**.
- 2 Press the (◀/▶ arrow) buttons to select **Wall** or **Table**.

Using Audyssey Dynamic Volume®

This feature provides a consistent sound volume between television programs, commercials, and between the loud and soft passages of movies.

- 1 Press the **MENU** button. Select **SETTINGS, SOUND, Audyssey Premium Television, Dynamic Volume**.
- 2 Press the (◀/▶ arrow) buttons to select **Night, Day**, or **Off**.

NOTE

- ❖ If Dynamic Range Control is set to On, this feature is automatically set to Off.
- ❖ This feature does not affect the audio signal output from the DIGITAL AUDIO OUT terminal.

Audyssey ABX™

Audyssey ABX™ technology uses sophisticated driver analysis and low frequency monitoring to extend the range and bass of small speakers.

To turn on Audyssey ABX™:

- 1 Press the **MENU** button. Select **SETTINGS, SOUND, Audyssey Premium Television, Audyssey ABX**.
- 2 Press the (◀/▶ arrow) buttons to select **Off/Low/High**.

Audyssey EQ® and Audyssey Volume Extension® are default settings that are set to On.

Using the surround sound feature

Surround settings help to create a thrilling surround sound experience with deep, rich bass from stereo sound sources. Your TV's audio will sound fuller, richer, and wider.

- ❖ Press the **MENU** button. Select **SETTINGS, SOUND, Surround**, and then select **On** or **Off**.

Chapter 8

Advanced features

Using your home network

- ❖ This TV can share videos, music, and photos across your home network and other connected products through the MediaShare feature. In order to do this, you will have to configure the network settings on your TV, see [“ePORTAL MediaShare \(Videos, Music, and Photos\)”](#) on page 157.
- ❖ If you want to use your home network with an Internet connection, you will have to configure the network settings on your TV. If necessary, change the network settings, see [“Setting up the Network”](#) on page 131.

If you use Internet services, see the following note before use.

Third party Internet services are not provided by Toshiba, may change or be discontinued at any time, and may be subject to third party restrictions. Toshiba makes no warranties, representations, or assurances about the content, availability, or functionality of third party content or services. Third party internet services may require the creation of a separate account through a computer with internet access, and payment of one-time and/or recurring charges.

Certain features currently not available in Canada/Mexico.

When using a Wireless network connection:

Wireless LAN and your Health:

Wireless LAN products, like other radio devices, emit radio frequency electromagnetic energy. However, the level of energy emitted by Wireless LAN devices is much less than the electromagnetic energy emitted by wireless devices like mobile phones.

Because Wireless LAN products operate within the guidelines found in radio frequency safety standards and recommendations, Toshiba believes Wireless LAN is safe for use by consumers. These standards and recommendations reflect the consensus of the scientific community and result from deliberations of panels and committees of scientists who continually review and interpret the extensive research literature.

In some situations or environments, the use of Wireless LAN may be restricted by the proprietor of the building or responsible representatives of the organization. Such restrictions may apply in environments where the risk of interference to other devices or services is perceived or identified as harmful.

If you are uncertain of the policy that applies to the use of wireless devices in a specific organization or environment, you are encouraged to ask for authorization to use the Wireless LAN device prior to turning on the equipment.

Using the TV in a wireless LAN environment:

- ❖ It is recommended to use IEEE 802.11a or IEEE 802.11n on 5 GHz for audio and SD video streaming.
- ❖ It is recommended to use IEEE 802.11n on 5 GHz for HD video streaming.
- ❖ It is recommended that the encoding rate of video content be 20 Mbps or less.
- ❖ It is not recommended to use 2.4 GHz for audio and video streaming.
- ❖ Content playback may be interrupted by surrounding interference.

Setting up the Network

You can select the Network Type.

- 1 Press the **MENU** button. Select **NETWORK > Network Setup**, and then press the **OK** button.
- 2 Press the (**▲/▼** arrow) buttons to highlight **Network Type**.
- 3 Press the (**◀/▶** arrow) buttons to select **Wired** or **Wireless**.
- 4 If you select **Wired**, see “[Advanced Network Setup](#)” on page 136. If you select **Wireless**, see the next section.

Wireless Setup

NOTE Continued AP (Access Point) connection is not guaranteed. Connection may be lost while watching TV.

There are three methods for wireless setup:

- ❖ **Easy Setup (WPS)**
If AP supports WPS, this can be used.
 - ❖ WPS is a standard designed to simplify the connection of wireless LAN equipment and the setup of network security features.
- ❖ **Assisted Setup (setup using the AP's notification information)**
Network Name, Authentication, and Encryption are decided based on information from the AP. You need to manually set the Security Key.
- ❖ **Manual Setup**
Requires manually entering all settings.

NOTE In order to secure your home network, it is strongly recommended that you use a wireless access point with encryption.

Easy Setup using PBC (Push button configuration)

- 1 Press the **MENU** button. Select **NETWORK > Network Setup**, and then press the **OK** button.
- 2 Press the (**▲/▼** arrow) buttons to select **Wireless Setup**, and then press the **OK** button.
- 3 Press the (**▲/▼** arrow) buttons to select **Easy Setup**, and then press the **OK** button.

- 4 Press the (◀/▶ arrow) buttons to select **PBC**.
- 5 Press the (▼ arrow) button to select **Start Scan**, and then press the **OK** button.
- 6 Following the onscreen instructions, push the appropriate button on your AP.
- 7 When a screen reporting that “the setup has succeeded” appears, press the **OK** button.

To cancel searching for the AP:

- ❖ Press the **BACK** button while searching for the AP. A message appears. Press the (◀/▶ arrow) buttons to select **Yes**, and then press the **OK** button.

Easy Setup using PIN (Personal Identification Number)

- 1 Press the **MENU** button. Select **NETWORK > Network Setup**, and then press the **OK** button.
- 2 Press the (▲/▼ arrow) buttons to select **Wireless Setup**, and then press the **OK** button.
- 3 Press the (▲/▼ arrow) buttons to select **Easy Setup**, and then press the **OK** button.
- 4 Press the (◀/▶ arrow) buttons to select **PIN**.
- 5 Press the (▼ arrow) button to select **Start Scan**, and then press the **OK** button.

The Scan screen appears.

- 6 Enter the PIN displayed on this screen into your computer or AP.
- 7 Press the (▲/▼ arrow) buttons to select the desired AP, and then press the **OK** button.

NOTE Check the MAC address on the label or in the manual of the AP and select an AP.

- 8 When a screen reporting that “the setup succeeded” appears, press the **OK** button.

To cancel searching for the AP:

- ❖ Press the **BACK** button while searching for the AP. A message appears. Press the (◀/▶ arrow) buttons to select **Yes**, and then press the **OK** button.

Assisted Setup

- 1 Press the **MENU** button. Select **NETWORK > Network Setup**, and then press the **OK** button.
- 2 Press the (**▲/▼** arrow) buttons to select **Wireless Setup**, and then press the **OK** button.
- 3 Press the (**▲/▼** arrow) buttons to select **Assisted Setup**, and then press the **OK** button.
- 4 Press the (**▲/▼** arrow) buttons to select the desired AP, and then press the **OK** button.

NOTE Check the MAC address on the label or in the manual of the AP and select an AP.

- 5 Select **Security Key**, and then press the **OK** button.
The Software Keyboard appears.
- 6 Input the Security Key using the Software Keyboard. For more information, see [“Using the software keyboard” on page 139](#).
- 7 To save your settings, press the **BLUE** button.

NOTE The Security Key must adhere to the following conditions:

- ❖ TKIP/AES: 8-63 ASCII or 64 Hex characters
- ❖ WEP: 5 or 13 ASCII or 10 or 26 Hex characters

- 8 Select **Done**, and then press the **OK** button.

NOTE Settings are not saved if the **BACK** button is pressed before Done is selected.

Manual Setup

- 1 Press the **MENU** button. Select **NETWORK > Network Setup**, and then press the **OK** button.
- 2 Press the (**▲/▼** arrow) buttons to select **Wireless Setup**, and then press the **OK** button.
- 3 Press the (**▲/▼** arrow) buttons to select **Manual Setup**, and then press the **OK** button.

- 4 Press the (▲/▼ arrow) buttons to select **Network Name**, and then press the **OK** button.
The Software Keyboard window appears.
 - 5 Input the Network Name using the Software Keyboard. For more information, see [“Using the software keyboard” on page 139](#).
 - 6 To save your settings, press the **BLUE** button.
 - 7 Press the (▲/▼ arrow) buttons to highlight **Authentication**. Press the (◀/▶ arrow) buttons to select **Open/Shared**, **WPA-PSK**, or **WPA2-PSK**.
 - 8 Press the (▲/▼ arrow) buttons to highlight **Encryption**. Press the (◀/▶ arrow) buttons to select **None**, **WEP**, **TKIP**, or **AES**.
-

NOTE

Certain encryption types are only compatible with specific authentication types.

- ❖ When Authentication is Open/Shared, only WEP or None are compatible.
- ❖ When Authentication is WPA-PSK or WPA2-PSK, only TKIP or AES are compatible.

When incompatible Authentication/Encryption pairings are attempted, a warning message will be displayed, and no connection attempt will be made until the incompatibility is resolved.

- 9 Press the (▲/▼ arrow) buttons to select **Security Key**, and then press the **OK** button.
The Software Keyboard window appears.
 - 10 Input the Security Key using the Software Keyboard. For more information, see [“Using the software keyboard” on page 139](#).
 - 11 To save your settings, press the **BLUE** button.
-

NOTE

This item is grayed out when Encryption is set to None.

- 12 Select **Done**, and then press the **OK** button.
When Encryption is set to **None**, a message appears.
- 13 Press the (◀/▶ arrow) buttons to select **Yes**, and then press the **OK** button.

NOTE Settings are not saved if the **BACK** button is pressed before Done is selected.

Wireless Information

The settings configured in Wireless Setup can be confirmed.

- 1 Press the **QUICK** button. Select **Wireless Information**, and then press the **OK** button.
- 2 Press the **RED** button to check the availability of surrounding APs.

A Wireless Information screen appears when a connection is successfully made.

<i>Item:</i>	<i>Description:</i>
Status	The message, "Connected" appears when the TV is connected to the AP The message, "Disconnected" appears when the TV is disconnected from the AP
Signal	Connection signal strength with the AP (STRONG/MEDIUM/WEAK)
Speed	The link speed with the AP
Mode	Working mode (11a, 11b, 11g, 11n)
Channel	The channel in use (1-165)
Network name	SSID set
Authentication	Authentication set
Encryption	Encryption set
Security key	Security Key set
AP MAC address	The AP's MAC address appears when the TV is connected to the AP
TV MAC address	The TV's MAC address
DHCP	The message, "Enabled" appears when you use DHCP. The message, "Disabled" appears when you do not use DHCP.
IP address	The TV's IP address
Subnet Mask	Value of the Subnet Mask
Default Gateway	Default GATEWAY's address

<i>Item:</i>	<i>Description:</i>
DNS	DNS's address

NOTE Even if an AP for IEEE 802.11n is used when Encryption is set to WEP or TKIP, the Speed value might be low. We recommend that the Encryption setting are changed to AES (Under manual setup).

Advanced Network Setup

- NOTE**
- ❖ When the DHCP function of the router connected to this TV is On, you can set Auto Setup to On or Off. (Usually set it to On.)
 - ❖ When the DHCP function of the router is Off, set Auto Setup to Off, and manually set the IP Address or DNS Address.
-

IP Address Setup

NOTE The settings in Auto Setup are linked to those selected in the DNS Setup menu. If Auto Setup is set to On, then Auto Setup in the DNS Setup menu will also be set to On.

Auto Setup:

- 1 Press the **MENU** button. Select **NETWORK > Network Setup**, and then press the **OK** button.
 - 2 Press the (▲/▼ arrow) buttons to select **Advanced Network Setup**, and then press the **OK** button.
 - 3 Press the (▲/▼ arrow) buttons to select **IP Address Setup**, and then press the **OK** button.
 - 4 Select **Auto Setup**. Press the (◀/▶ arrow) buttons to select **On**.
-

NOTE Other items are grayed out when Auto Setup is set to On.

Manual Setup:

- 1 Press the **MENU** button. Select **NETWORK > Network Setup**, and then press the **OK** button.

- 2 Press the (▲/▼ arrow) buttons to select **Advanced Network Setup**, and then press the **OK** button.
- 3 Press the (▲/▼ arrow) buttons to select **IP Address Setup**, and then press the **OK** button.
- 4 Select **Auto Setup**. Press the (◀/▶ arrow) buttons to select **Off**.
- 5 Press the (▲/▼ arrow) buttons to highlight **IP Address**. Then press the **OK** button.
- 6 Press the (◀/▶ arrow) buttons to select the **IP Address** field and use the 0-9 buttons to enter in a digit. Use the (▶ arrow) button to select the subsequent fields. To save the setting, press the **OK** button.

NOTE IP address field numbers must be between 0 and 255. If you input an incompatible number and press the **OK** button. The field number will be reset to the previous value.

- 7 Press the (▲/▼ arrow) buttons to highlight **Subnet Mask**, and edit in the same way as IP Address.
- 8 Press the (▲/▼ arrow) buttons to highlight **Default Gateway**, and edit in the same way as IP Address.

NOTE If you manually set the IP address, you must not use the same IP address for any other device. The IP address you use should be a private address. If you do not know the correct values to use, contact your network administrator or internet service provider.

DNS Setup

-
- NOTE**
- ❖ When the DHCP function of the router connected to this TV is Off, set Auto Setup to Off, and manually set the DNS address(es). Your Internet Service Provider should have provided these to you.
 - ❖ The settings in Auto Setup are linked to those selected in the IP Address Setup menu. If Auto Setup is set to On, then Auto Setup in the IP Address Setup menu will also be set to On.
-

Auto setup:

- 1 Press the **MENU** button. Select **NETWORK > Network Setup**, and then press the **OK** button.

- 2 Press the (▲/▼ arrow) buttons to select **Advanced Network Setup**, and then press the **OK** button.
- 3 Press the (▲/▼ arrow) buttons to select **DNS Setup**, and then press the **OK** button.
- 4 Select **Auto Setup**. Press the (◀/▶ arrow) buttons to select **On**.

NOTE Other items are grayed out when Auto Setup is set to On.

Manual setup:

- 1 Press the **MENU** button. Select **NETWORK > Network Setup**, and then press the **OK** button.
- 2 Press the (▲/▼ arrow) buttons to select **Advanced Network Setup**, and then press the **OK** button.
- 3 Press the (▲/▼ arrow) buttons to select **DNS Setup**, and then press the **OK** button.
- 4 Select **Auto Setup**. Press the (◀/▶ arrow) buttons to select **Off**.
- 5 Press the (▲/▼ arrow) buttons to highlight **Primary DNS Address**.
- 6 Press the (◀/▶ arrow) buttons to highlight the field you want to change, and then use the number buttons to input the Primary DNS Address. To save the setting, press the **OK** button.

NOTE DNS address field numbers must be between 0 and 255. If you input an incompatible number and press the OK button, the field number will be reset to the previous value.

- 7 Press the (▲/▼ arrow) buttons to highlight **Secondary DNS Address**, and edit in the same way as Primary DNS Address.

MAC Address

You can view the fixed MAC address for the TV.

- 1 Press the **MENU** button. Select **NETWORK > Network Setup**, and then press the **OK** button.
- 2 Press the (▲/▼ arrow) buttons to select **Advanced Network Setup**, and then press the **OK** button.

- 3 Press the (▲/▼ arrow) buttons to select **MAC Address**, and then press the **OK** button.

Network Connection Test

This function checks Internet connectivity.

- 1 Press the **MENU** button. Select **NETWORK > Network Setup**, and then press the **OK** button.
- 2 Press the (▲/▼ arrow) buttons to select **Network Connection Test**, and then press the **OK** button.

A message appears to indicate whether the connection was successful or not.

NOTE Favorable Network Connection Test results do not guarantee an Internet Connection. Depending on the situation, some Internet features may not be available.

To cancel Network Connection Test, press the **EXIT** button while searching for the Internet connection.

Using the software keyboard

You can enter text using the Software Keyboard. Two modes are available: full keyboard and keypad. Keypad is the default mode.

The Software Keyboard window will appear when you press the **OK** button on a field that accepts character input.

NOTE When using the SmartTV features, software keyboard availability depends on the Internet service being accessed.

Enter text using the keypad

- 1 Highlight the desired character on the onscreen software keyboard.
- 2 Repeat Step 1 and 2 until you have entered all desired text.
- 3 Press the **BLUE** button to save your settings and return to the previous screen.





Enter text using the full keyboard

- 1 Highlight the desired character on the onscreen software keyboard.
- 2 Press the **OK** button.

- 3 Repeat Step 1 and 2 until you have entered all desired text.
- 4 Press the **BLUE** button to save your settings and return to the previous screen.

NOTE If the **BACK** button is pressed, changes are not saved and the software keyboard window is closed.

Input operation on the remote control:

<i>Item:</i>	<i>Description:</i>
	Inputs the selected character
0-9	Inputs numbers directly in keyboard mode. In keypad, these keys are used to select a character for entry.
	Moves the character highlight
	Moves the cursor
	Moves the cursor to the head of a character string
	Moves the cursor to the end of a character string
RED	Deletes one character to the left of the cursor
GREEN	Selects full keyboard or keypad mode
YELLOW	Chooses an accented version of the current letter, if applicable
BLUE	Saves changes and closes the Software Keyboard window
BACK	Closes the Software Keyboard window without saving changes

Performing a Software Upgrade

TOSHIBA may offer upgrades for the TV's software in the future. The TV's software is upgraded via the Network.

NOTE An Internet connection is required.

Before downloading software:

- 1 Configure your TV to connect to the Internet.

- NOTE
- ❖ You will not be able to use the TV set while performing the upgrade.
 - ❖ Do not turn off the TV during the upgrade.
 - ❖ By upgrading, the factory default values may be changed.
-

- 2 Press the **MENU** button. Select **GET HELP, Software Upgrade**, and then press the **OK** button.

The Network Upgrade screen appears.

- 3 Press the **OK** button.
-

- NOTE
- If the network is not available, a warning message appears.
-

- 4 After a successful download, the TV software upgrade will start automatically.

Viewing the Software Licenses

The Licenses for the software used in this TV are available for viewing.

- ❖ Press the **MENU** button. Select **GET HELP, Software Licenses**, and then press the **OK** button.

A screen appears displaying all the licensing information required for the television's software.

Using the SmartTV features

NOTE

- ❖ You need to connect to the Internet before using this feature, see [“Setting up the Network” on page 131](#).
- ❖ Certain services may not be currently available in your area.
- ❖ User registration or login may be required to use some services.
- ❖ Third party internet services are not provided by Toshiba, may change or be discontinued at any time and may be subject to Internet service provider restrictions. Toshiba makes no warranties, representations, or assurances about the content, availability or functionality of third-party content or services. Use of third party Internet services may require the creation of a separate account through a computer with Internet access and/or payment of one-time and/or recurring charges and membership. Not all third party services may be available on or compatible with this product. In order to experience the full suggested capabilities of this product, fully-compatible devices may be required.

NOTE

- ❖ If the display of the date and time is wrong, turn off the TV, and turn it on again.
 - ❖ The menu items for features like the Apps may change in the upgrade process.
-

eMANUAL

The eMANUAL provides on-screen, context-sensitive, instructions that describe the TV features.

ePORTAL page

The ePORTAL is the “home page” that allows you to control the various elements of your Smart TV system. This includes traditional features such as Apps, Internet (web browser), and MediaShare (Media Player), as well as other unique Toshiba features such as SearchAll, MediaGuide, Events, and Messages.

ePORTAL SearchAll

The SearchAll function scours the Internet and your connected devices for content. This search finds content from:

- ❖ TV programming and Video On Demand (VOD)

- ❖ MediaShare (Media Player): Connected Media Servers and USB devices
- ❖ The Internet

Performing a Search

You can perform a search using the **SEARCH** button on the remote control or the SearchAll bar on the ePORTAL page.

- 1 From the remote control, press the **SEARCH** button while watching television programs.
Or
- 2 From the ePORTAL, select the SearchAll bar at the top of the screen and press **OK**.
- 3 Type a keyword into the Search Bar using the onscreen keyboard or the wireless QWERTY keyboard. A maximum of 50 characters can be entered for a search.
- 4 After entry is complete, select the **SEARCH** button on the screen and press **OK**.
- 5 The search results page will display a list of content containing the keyword. The Search may take up to 60 seconds to complete.
- 6 Highlight a search result and press the **OK** button to view the content.
- 7 To view more search results, select **MORE ..>** and press **OK**. The **MORE ..>** button will jump to each category's search results.
 - ❖ When you select **MORE ..>** in the MediaShare (MediaPlayer), you will need to enter the keyword again in the search.

NOTE

- ❖ Depending on the status of the target device (media server), the Media Player Search and Search All features may not function correctly, such as if the server is busy or does not support a search function.
 - ❖ Additional options are dependent on the current source and/or content.
 - ❖ The search keywords that you enter are stored in memory. The maximum number that can be stored at one time is 30. After 30 words is reached, the oldest words will be deleted as new words are added.
-

ePORTAL Apps

The ePORTAL Apps can be used to display bonus content through content service providers such as:

- ❖ Netflix®
- ❖ VUDU Apps™
- ❖ VUDU Movies™
- ❖ YouTube®
- ❖ CinemaNow®
- ❖ MediaGuide
- ❖ eMANUAL

NOTE

Certain services may not be available in your area.

Select an App from the ePORTAL

To select an App from the ePORTAL:

- 1 Open the ePORTAL page.
- 2 Click on the Apps icon.
- 3 A new page opens displaying the available Apps.
- 4 Select the desired App and press OK.

Netflix®

Watching movies with Netflix®

- 1 Press the **NETFLIX** button or press the **APPS** button on the remote control and select the **Netflix** icon.
- 2 Follow the onscreen instructions.

After having activated Netflix® player and prepared an Instant Queue, movies and TV episodes in your Instant Queue will appear on the TV screen. Select the desired content using the remote control.

-
- NOTE**
- ❖ The resolution of video content streamed from Netflix® varies depending on the communication speed and bit-rate.
 - ❖ Future upgrades can change the screens and messages displayed in the Netflix® feature.
 - ❖ Netflix® is supported in the U.S. and Canada, and may not be available in other countries or regions.
-

To close Netflix®, press the **EXIT** button.

To confirm the Netflix ESN (Electronic Serial Number):

- 1** Press the **MENU** button. Select **NETWORK > Smart Apps Setup > Netflix Setup**, and then press the **OK** button.
- 2** Press the (▲/▼ arrow) buttons to select **ESN**, and then press the **OK** button.

The Netflix ESN screen appears.

To deactivate your device:

- 1** Press the **MENU** button. Select **NETWORK > Smart Apps Setup > Netflix Setup**, and then press the **OK** button.
- 2** Press the (▲/▼ arrow) buttons to select **Deactivation**, and then press the **OK** button.
- 3** Press the (◀/▶ arrow) buttons to select **Yes**, and then press the **OK** button.

VUDU™

VUDU™ is an on-demand service that offers high definition movies on the Web.

- 1** Press the **APPS** button on the remote control, or select the Apps icon on the ePORTAL.
- 2** Press the (◀/▶ arrow) buttons to select **VUDU**, and then press the **OK** button.

-
- NOTE** Use of VUDU™ requires a working broadband Internet connection (1 to 2 Mbps for SD video, 2.25 to 4.5 Mbps for HD video, and 4.5 to 9 Mbps for HDX video).
-

To close VUDU, press the **EXIT** button.

To deactivate your device:

- 1 Press the **MENU** button. Select **NETWORK > Smart Apps Setup > VUDU Deactivation**, and then press the **OK** button.
 - 2 Press the (◀/▶ arrow) buttons to select **Yes**, and then press the **OK** button.
-

NOTE If the VUDU™ icons are not shown in the ePORTAL, you may need to update the TV firmware. You can access VUDU™ through the web browser.

YouTube™

YouTube is a video-sharing service managed by YouTube™, LLC.

This TV allows you to view YouTube™ video content.

- 1 Press the **APPS** button on the remote control or select the Apps icon on the ePORTAL.
- 2 Press the (◀/▶ arrow) buttons to select **YouTube**, and then press the **OK** button.
- 3 Press the (▲/▼/◀/▶ arrow) buttons to select the file you wish to view, and then press the **OK** button.

To close YouTube™, press the **EXIT** button.

NOTE If the YouTube™ icon is not shown in the ePORTAL, you may need to update the TV firmware. You can also access YouTube™ through the web browser.

NOTE

- ❖ YouTube™ content has been independently managed by YouTube™, LLC.
- ❖ Not all YouTube™ content that can be accessed by computer may be viewed with this TV.
- ❖ This TV may not be able to do some operations that computer can do.
- ❖ Depending on network environment and the use situation, content may be difficult to view.
- ❖ Though the same volume value, the actual volume might be greatly different depending on content.
- ❖ This TV might take time during start-up and the playback of content.
- ❖ Content that the user may feel is improper or offensive may be included in the content of YouTube™.
- ❖ We do not assume any responsibility for content that YouTube™ offers.
- ❖ If you have any questions about YouTube™ content, contact YouTube™, LLC.
- ❖ The content of service and the screen that can be used may be changed without notice.
- ❖ You will need to use a computer to post videos to YouTube™.
- ❖ Not all content can be viewed normally when you access Web sites other than YouTube™ Leanback through this TV.

CinemaNow®

CinemaNow® is an on-demand service that offers high definition movies on the Web.

- 1 Press the **APPS** button on the remote control or select the Apps icon on the ePORTAL.
- 2 Press the (◀/▶ arrow) buttons to select **CinemaNow**, and then press the **OK** button.

To close CinemaNow®, press the **EXIT** button.

ePORTAL Internet

Web Browser

The web browser on this TV lets you explore everything the web has to offer. Along with access to popular places, you'll be able to

search for and browse your favorite sites, and find all the content you want, with simple, intuitive navigation.

The web browser on this device:

- ❖ does not support platform-dependent technologies such as ActiveX.
- ❖ only supports preinstalled plug-ins.
- ❖ may not support media formats other than the following: JPEG / PNG / GIF.
- ❖ uses a single built-in font. Some text may not be displayed as intended.
- ❖ does not support downloading of files or fonts.
- ❖ is a TV browser. It may work differently than PC browsers.
- ❖ does not support parental control or locks, and it is the responsibility of the user to monitor browser usage by minors.

In addition, some web pages may exceed the memory allotment of the web browser. The web browser will close when this happens.

NOTE

Some pages may not be displayed correctly or may display differently on different devices.

Using the web browser

- 1 Connect to the network.
- 2 Press the **ePORTAL** button on the remote control to access the ePORTAL page.

The web browser page is displayed.

NOTE

Pressing the **INTERNET** button on the remote control will also launch the web browser.

- 3 Use the (▲/▼/◀/▶ arrow) buttons to scroll to the **Internet** icon and press **OK**.
- 4 Use the (▲/▼/◀/▶ arrow) buttons to scroll to the **URL Address Bar** and press **OK**.
- 5 Enter the desired URL address by using the (▲/▼/◀/▶ arrow) buttons or by using the Wireless QWERTY keyboard. Press the **BLUE** button on the remote control or QWERTY keyboard when finished.

-
- 6 You can now browse websites on your TV using the (▲/▼/◀/▶ arrow) buttons on the remote control or by using the Wireless QWERTY keyboard.
-

NOTE Select Mouse Emulation by pressing the **GREEN** button on the remote control to navigate with a driverless wireless mouse (wireless mouse is not included).

Browsing favorite websites

- 1 Connect to the network.
 - 2 Press the **ePORTAL** button on the remote control to access the ePORTAL page.
-

NOTE Pressing the **INTERNET** button on the remote control will also launch the web browser.

- 3 Use the (▲/▼/◀/▶ arrow) buttons to scroll to the **Internet** icon and press **OK**.
 - 4 Use the (▲/▼/◀/▶ arrow) buttons to scroll to **Favorites STAR** and press **OK**.
-

NOTE By adding frequently visited websites to Favorites, you can browse them easily.
You can view the addresses of the websites you visited previously.

- 5 Select the item or folders to move to the desired URL address and press **OK**.
-

NOTE You can press the **GREEN** button on the remote for thumbnail view of all your favorites.

- 6 You can now browse websites on your TV using the (▲/▼/◀/▶ arrow) buttons on the remote control or via using the Wireless QWERTY keyboard.
-

NOTE Select **Mouse Emulation** by pressing the **GREEN** button on the remote control to navigate with a driverless wireless mouse (wireless mouse is not included).

Adding Favorites Websites

- 1 Connect to the network.
 - 2 Press the **ePORTAL** button on the remote control to access the ePORTAL page.
-

NOTE Pressing the **INTERNET** button on the remote control will also launch the web browser.

- 3 Press the Navigation buttons to scroll to the **Internet** icon and press **OK**.
 - 4 Follow “Using the web browser” on page 148 to display your desired website.
 - 5 Press the Navigation buttons to scroll to **Favorites STAR** on the Browser Menu Bar and press **OK**.
-

NOTE By adding frequently visited websites to Favorites, you can browse them easily.
You can view the addresses of the websites you visited previously.

- 6 Press **OK** on the remote control to save the desired website to your favorites.
-

NOTE The desired website is highlighted and displayed on the top row with the + add icon.
The + add icon will change to a page icon after the website has been saved to favorites.

- 7 Press the **BACK** button on the remote to return to browsing your website.

Launch the Internet and access a specific web page

- 1 Press the **INTERNET** button on the remote or select the Internet icon on the ePORTAL page.
- 2 Use the onscreen keyboard or the wireless QWERTY keyboard to type the URL address into the address bar.
- 3 Launching the web page is dependent on which input mode you are using:
 - ❖ If using the remote control, select the **OK** button on the address bar to view the page.

- ❖ If using the onscreen keyboard, press the **BLUE** button to view the page.
- ❖ If using the USB/QWERTY keyboard, press the **ENTER** button to view the page.

ePORTAL Messages

You can create personal messages on your TV using the Messages feature.

Launch the Messages feature

- 1 Select the Messages icon on the ePORTAL page.
- 2 Press the **GREEN** button on the remote to open a new message window.
- 3 Use the onscreen keyboard or the wireless QWERTY keyboard to type your message into the message field.
- 4 Press the **OK** button to save your message.

ePORTAL Events

You can set events on your TV through the Events Calendar feature.

Create an event

- 1 Select the Events icon on the ePORTAL page.
- 2 A calendar is displayed. Move to the Previous Month or Next Month by using the left and right jump buttons (<< >>) on the remote.
- 3 Highlight the desired date using the cursor keys, and press **OK**. A new Event window is displayed.
- 4 Use the onscreen keyboard or the wireless QWERTY keyboard to type in the event information.
- 5 If a recurring event, you can use the **Repeat** option to set the frequency of occurrence by using the Jump buttons (<< >>) on the remote.
- 6 Press the **GREEN** button to save the new event.

Delete an event

- 1 Move to the Previous Month or Next Month by using the left and right jump buttons on the remote. Highlight the desired date using the cursor keys.
- 2 Press the **RED** button to delete the event(s) for that date.

Edit an event

- 1 Select the Event in the Event list. Press **OK**.
- 2 The Edit Event window is displayed. You can change the date, event information, and repeat options.

ePORTAL Favorite Sites

You can access your favorite (“bookmarked”) Internet sites from the ePORTAL.

Access your Internet favorites via the ePORTAL

- 1 Select the Favorite Sites icon on the ePORTAL page.
The bookmarked sites are displayed on the page along with the website name and URL address.
- 2 Select the bookmarked site and press the **OK** button.
The web browser will launch and display the selected site.

Edit ePORTAL Favorites

You can show, hide, and change the position of your favorite apps located on the bottom row of the ePORTAL page.

- 1 Select the gear icon at the top right of the ePORTAL page to access the Preferences window, and select the Edit Favorites menu.
- 2 Select the **Show/Hide** menu option. In the new window, move the focus to the desired app and press **OK** to add a check (show) or remove a check (hide). Highlight **Save** and press **OK** to store your changes.
- 3 To change the order of the apps in the Favorites section, select the **Move** option from the **Edit Favorites** menu.
- 4 From the Move window, highlight the app you wish to move and press the **OK** button. The icon will switch to Move mode. Use the left/right cursor keys to move to the desired position.
- 5 Press **OK** again to confirm the new position. Highlight **Save** and press **OK** to save your changes.

ePORTAL Preferences

Use ePORTAL Preferences to customize the look and feel of the ePORTAL.

From Preferences, you can:

- ❖ Adjust the background by selecting different colors
- ❖ Edit favorite Apps by moving and selecting which favorites to show or hide
- ❖ Adjust your Event Notification flag setting

To access the Preferences window, select the gear icon in the top right corner of the ePORTAL.

MediaGuide

Using MediaGuide

The MediaGuide is an integrated service that provides access to both television programming and Internet content based on the Rovi™ system.

Before beginning your MediaGuide installation, please make sure your initial setup for channel tuning, IR blaster, and network settings is completed. For instructions on the initial setup please see [“Initial Setup and Menu” on page 51](#). For the initial installation of the MediaGuide, please follow the onscreen instructions.

NOTE

The Rovi Corporation and/or its subsidiaries and related affiliates are not in any way liable for the accuracy or availability of the program schedule information or other data in the Rovi Guide system and cannot guarantee service availability in your area. In no event shall Rovi Corporation and/or its related affiliates be liable for any damages in connection with the accuracy or availability of the program schedule information or other data in the Rovi Guide system.

MediaGuide setup

When you access MediaGuide for the first time from the **GUIDE** button on the remote control, a step-by-step installation wizard will appear. Follow the onscreen instructions in order to complete the setup and view your local TV listings.

NOTE If you see an error message saying that the MediaGuide was not able to connect to the network, you should check your network connections before trying again.

The step-by-step installation wizard will appear again after performing any of the following tasks:

- ❖ Changing the ANT/CABLE In setting
- ❖ Changing the Country setting
- ❖ Changing the Device Type or Input under the IR Blaster Setup menu
- ❖ Reset MediaGuide

Operating the MediaGuide

- 1 Press **GUIDE** on the remote control or select the **MediaGuide** from the ePORTAL from the Apps screen.
- 2 The MediaGuide screen will be displayed with the defaulted setting; the first menu is set to **ALL**, the secondary menu is set to **TV Listings**, and the current channel is highlighted.
- 3 To navigate within the MediaGuide, press the (▲/▼/◀/▶ arrow) buttons to select content and move within a menu and then press the **OK** button to select an item option.
 - ❖ Selecting a channel or TV listing will turn to live TV for the particular show.
 - ❖ If the show is not being aired at the time it has been selected, you will be directed to the Overview screen within the Overview screen to see upcoming shows. Select the **Watch** option to view it.



(Sample Image) MediaGuide Top-Level menu

-
- 4 In the subsequent menus, use the (◀/▶ arrow) buttons to navigate between menu levels.

The sub-menus include My Profile; Movies, Settings, TV, Search, and TV Listings.

NOTE

- ❖ Third party Internet services are not provided by Toshiba, may change or be discontinued at any time and may be subject to Internet service provider restrictions. Toshiba makes no warranties, representations, or assurances about the content, availability or functionality of third-party content or services. Use of third party Internet services may require the creation of a separate account through a computer with Internet access and/or payment of one-time and/or recurring charges and membership. Not all third party services may be available on or compatible with this product. In order to experience the full suggested capabilities of this product, fully-compatible devices may be required.
 - ❖ Service Information may not be displayed or there may be little service information displayed depending on the area or the kind of broadcast.
 - ❖ The MediaGuide can only be used when your TV is connected to the Internet.
 - ❖ Starting and operation of this service may take several minutes.
 - ❖ Software updates may be needed in order to use this service.
 - ❖ During use of the MediaGuide, usage information will be notified to the Rovi server to ensure continued efficient operation of the guide.
 - ❖ Rovi Corporation and/or its subsidiaries and related affiliates are not in any way liable for the accuracy or availability of the program schedule information or other data in the Rovi Guide system and cannot guarantee service availability in your area. In no event shall Rovi Corporation and /or its related affiliates be liable for any damages in connection with the accuracy or availability of the program schedule information or other data in the Rovi Guide system.
 - ❖ In order to experience the full suggested capabilities of this product, fully-compatible devices may be required. This feature is not available in Mexico, and certain features may not be available in all countries.
-

Selecting a listing

If you can select and open a TV program, movie, or celebrity, an Overview screen will appear with general information about the selected item. It also contains options such as watch, bookmark, or see a trailer. The detail screen has several on-screen buttons such as Overview and Summary. To open these options:

- 1 Press the (▲/▼/◀/▶ arrow) buttons to highlight the option.
- 2 Press the **OK** button to select the option.

Viewing a detail screen

The detail screen contains menu options that display additional information such as biographies and reviews. The TV Listing/Movie Detail menus can contain information such as History, Episodes - For TV series only, Overview, Summary, Review, Cast & Crew, and others.

Celebrity detail menus contain different items such as History, Overview, Biography, and Credits.

NOTE

The actual menus displayed on the detail screen vary depending on the service that you have configured for the MediaGuide and what types of information about the selected item are available to be displayed. There may be instances where data cannot be acquired from the server due to network problems. Obtaining accurate MediaGuide data depends on the timing of the updates by the guide data provider and your Internet connection.

Searching in MediaGuide

You can use the Search menu, within the MediaGuide to find movies or program by name. You can search from the primary menu, or from within the TV or Movie menus.

To search using a keyword:

- 1 Select the Search option from one of the menus.
- 2 Type in a keyword using the search keypad.
- 3 Press the **OK** button to select the button.
- 4 When the title you want is in the suggestion list, press the right button to move to the list and then the Up or down button to highlight it.
- 5 Press the **OK** button on the search option screen for search results to select the item.

- 6 Press the **OK** button to open the detail screen for that item.

To search all of the connected media devices across your network as well as the TV programming, use the SearchAll feature in the ePORTAL, see “ePORTAL SearchAll” on page 142.

Reset MediaGuide

To reset the MediaGuide, please follow these steps:

- 1 Press the **MENU** button on the remote control.
- 2 Select **Network>Smart Apps Setup>Reset MediaGuide**.
- 3 Press the **OK** button.
A confirmation message will be displayed.
- 4 Select **Yes** to proceed. It may take a few moments to complete the reset.

You can also reset the MediaGuide from the MediaGuide from the setting menu

NOTE If the MediaGuide cannot launch or is not functioning correctly, reset the MediaGuide using the instructions above.

ePORTAL MediaShare (Videos, Music, and Photos)

Use the Videos, Music, and Photos icons on the ePORTAL to quickly access video, music, and image files located on storage media or your home network.

There are two ways to play content.

The TV can control and play content on a MediaShare (Media Player). The Media Server is a device with server functions that stores media content for playback on a MediaShare (Media Player).

NOTE

- ❖ Do not insert/remove a USB device while in use.
- ❖ The **MENU** button is not available while using the MediaShare (Media Player) feature.

MediaShare (Media Player) specifications

Devices:

- ❖ USB device: USB Mass Storage Class devices (MSC)

-
- ❖ Connected Media Server:
Your computer (for example)
-

- NOTE
- ❖ Connectivity is not guaranteed for all devices.
 - ❖ Some functionality may be lost with a USB HUB connection.
-

Supported file system:

- ❖ FAT16 and FAT32
-

- NOTE
- You must obtain any required permission from copyright owners to download or use copyrighted content. Toshiba cannot and does not grant such permission.
-

Basic operation

Using MediaShare (Media Player) with a USB device

When Auto Start is enabled, you will be asked if you want to start the MediaShare (Media Player) when a USB device is inserted. If Auto Start is disabled (or if you want to connect to a media server on the network), you must manually start the MediaShare (Media Player) from the ePORTAL.

To change the Auto Start setting

- 1 Press the **MENU** button. Select **NETWORK**, **Media Player**, **Setup**, and then press the **OK** button.
- 2 Press the (▲/▼ arrow) buttons to highlight **USB Auto Start**.
- 3 Press the (◀/▶ arrow) buttons to select **On** or **Off**.

Auto Start

- 1 Insert a USB device into the USB terminal.
A prompt appears.
- 2 Press the (◀/▶ arrow) buttons to select **Yes**, and then press the **OK** button.
- 3 Press the (▲/▼ arrow) buttons to select **Video**, **Music**, or **Photos**, and then press the **OK** button.
- 4 To change the device, press the (▲/▼/◀/▶ arrow) buttons to select the devices on the screen, and then press the **OK** button.
- 5 Press the (▲/▼ arrow) buttons to select the device.

NOTE If Auto Start is set to Off, you can start the MediaShare (Media Player) manually.

Manual Start

- 1 Insert a USB device into the USB terminal.
- 2 Press the **ePORTAL** button. Select the **Video**, **Music**, or **Photos** icon, and then press the **OK** button.
A screen showing photo thumbnails or a list of files (videos or music) appears.
- 3 To change the device, press the (**▲/▼/◀/▶** arrow) buttons to select the **Device Name** button on the screen, and then press the **OK** button.
A screen showing photo thumbnails or a list of files (movies and music) appears.
- 4 Press the (**▲/▼** arrow) buttons to select the device.

To select a file in the list of contents

- 1 Press the (**▲/▼/◀/▶** arrow) buttons to select a file or folder.
- 2 Press the **OK** button to move to the next layer, or press the **BACK** button to return to the previous layer.

To close the MediaShare (Media Player)

- ❖ Press the **EXIT** button.
The TV will return to the last-viewed channel or video input.

Using MediaShare (Media Player) with a Media Server

You need to configure a home network before using this feature, see “Setting up the Network” on page 131.

- 1 Press the **ePORTAL** button.
- 2 Select the **Video**, **Music**, or **Photos** icon, and then press the **OK** button.
A screen showing photo thumbnails or a list of files (movies and music) appears.
- 3 To change the device press the (**▲/▼/◀/▶** arrow) buttons to select the device name on the screen, and then press the **OK** button.
- 4 Press the (**▲/▼** arrow) buttons to select the device.

5

To select a file in the list of contents

- 1 Press the (▲/▼/◀/▶ arrow) buttons to select a file or folder.
- 2 Press the **OK** button to move to the next layer, or press the **BACK** button to return to the previous layer.

To close the MediaShare (Media Player)

- ❖ Press the **EXIT** button.

The TV will return to the last-viewed channel or video input.

To display the device information

- 1 Press the **QUICK** button to open the Quick menu in list mode or Multi View mode.
- 2 Press the (▲/▼ arrow) buttons to select **Device Information**.

Viewing movie files**Basic Playback**

- 1 Select a file, see [“To select a file in the list of contents” on page 159](#).
- 2 Press the **OK** button or **PLAY** button to begin playback.

NOTE Depending on the file size, it may take some time to start playback.

- 3 Press the **STOP** button to stop playback.
- 4 If playback finishes before **STOP** is pressed, the screen returns to the list.

NOTE When the repeat mode is set to All, the next file will start playing automatically.

To pause playback

- ❖ Press the **PAUSE** button during playback. You can move to the desired replay position by pressing the (◀/▶ arrow) buttons during **PAUSE**.
- ❖ To resume normal playback, press the **PLAY** button.



NOTE The PAUSE button or operations during Pause may not be functional depending on content or media server.

To locate a specific file

- ❖ Press the **Skip Reverse** or **Skip Forward** button repeatedly to access the desired file.
- ❖ (

NOTE These features may not be operable depending on the content or media server.

To set the repeat mode

- 1 Press the **QUICK** button.
The current repeat setting appears.
- 2 Press the (/  arrow) buttons to select **Off**, **All**, or **1**.
- 3 Press the **BACK** button. The setting is effective until the TV is turned off.

<i>Mode:</i>	<i>Description:</i>
Off	The content is played back only once
All	All content in the same folder are repeatedly played back
1	The same content is repeatedly played back

To display the file status information

- 1 Press the **INFO** button during playback. The information will be displayed at the bottom of the screen.
- 2 Press the **INFO** button again to hide the information.

NOTE The information may not correctly display depending on the content or media server.

File specifications:

USB use:

- ❖ **File format:** MPEG2 PS, MPEG2 TS
- ❖ **Video:** MPEG2, H.264
- ❖ **Audio:** MPEG1-Layer2/MPEG1-Layer3/Dolby® Digital (AC3)/LPCM, ACC
- ❖ **Maximum number of files:** 1000 per folder

Content on Connected Media Server:

- ❖ **File format:** MPEG2 PS, MPEG2 TS, MP4*, WMV*
 - ❖ **Video:** MPEG2(PS), H.264*
 - ❖ **Audio:** LPCM/MPEG1-Layer1/MPEG1-Layer2/MPEG2-Layer2/Dolby Digital (AC3)/AAC
 - ❖ **Maximum number of files:** 1000 per folder
 - ❖ **Maximum video resolution:** 1920 x 1080
-

NOTE

It may not be possible to use certain playback or display some files. In some cases certain files and servers may not support playback features, such as pause.

Playing music files

Basic Playback:

- 1 Select a file, see [“To select a file in the list of contents” on page 159](#). Press the **OK** or **PLAY** button to begin playback.
-

NOTE

Depending on the file size, it may take some time to start playback.

- 2 Press the **STOP** button to stop playback.

If playback finishes before the **STOP** button is pressed, the screen returns to the list.

To pause playback:

- 1 Press the **PAUSE** button during playback.
- 2 To resume normal playback, press the **PLAY** button.



NOTE The **PAUSE** button or operations during Pause may not be functional depending on content or media server. Certain processes may take some time to complete.

To locate a specific file:

- ❖ Press the **Skip Reverse** or **Skip Forward** button repeatedly to access the desired file.
- ❖ (

NOTE These features may not be operable depending on the content or media server.

To set the repeat mode:

- 1 Press the **QUICK** button.
The current repeat setting appears.
- 2 Press the (/ arrow) buttons to select **Off**, **All**, or **1**.
- 3 Press the **BACK** button. The setting is effective until the TV is turned off.

<i>Mode:</i>	<i>Description:</i>
Off	The content is played back only once
All	All content in the same folder are repeatedly played back
1	The same content is repeatedly played back

To display the file status information:

- 1 Press the **INFO** button during playback.
The information appears at the bottom of the screen.
 - 2 Press the **INFO** button again to hide the information.
-

NOTE The information may not correctly display depending on the content or media server.

File specifications:

USB use:

- ❖ **File format:** MP3, MP4 (AAC), LPCM
- ❖ **Sampling frequency:** 32 kHz, 44.1 kHz, 48 kHz
- ❖ **Bit rate:** From 32 to 320 kbps
- ❖ **Maximum number of files:** 1000 per folder

Content on Connected Media Server:

- ❖ **File format:** MP3, LPCM
- ❖ **Sampling frequency:** 32 kHz, 44.1 kHz, 48 kHz
- ❖ **Bit rate:** From 32 to 320 kbps
- ❖ **Maximum number of files:** 1000 per folder

NOTE

It may not be possible to use certain playback or display some files. In some cases certain files and servers may not support playback features, such as fast-forward.

Viewing photo files**Multi View mode**

This view mode allows you to search for photos in a grid format.

These pictures are displayed using thumbnail data in each image file.

- 1** Press the (▲/▼/◀/▶ arrow) buttons to move the highlight by one window.

If all of the photos will not fit in one screen, when pressing the (▲ arrow) button at the top left thumbnail, the screen will scroll up one by one. Similarly, when pressing the (▼ arrow) button at the bottom right thumbnail, the screen will scroll down one by one.

- 2** When you select a folder, press the **OK** button to move to the next layer. Press the **BACK** button to move back to the previous layer.
- 3** Press the **OK** button to view the selected photo in Single View mode.

-
- NOTE
- ❖ Displaying thumbnail data may take time.
 - ❖ In order to use the ▲/▼ arrow to scroll the screen, there must be enough content to take up two screens.
-

Single View mode

In this view mode, only files located in the selected directory are displayed. When moving from Multi View mode to Single View mode, the currently selected photo appears.

- 1 On Multi view mode, press the (▲/▼/◀/▶ arrow) buttons to select a file, and then press the **OK** button.
 - 2 Press the (◀/▶ arrow) buttons to view the next or previous file.
-

- NOTE
- Single view mode is changed to Multi View mode when the **BACK** button is pressed.
-

Slideshow mode

This view allows you to watch a slideshow of the photos. In this mode, only files located in the selected directory appear.

- 1 To switch to Slideshow mode, press the **OK** button while in Single View mode. To return to Single View mode, press the **OK** button again.
- 2 Press the (◀/▶ arrow) buttons to view the next or previous file.

Mode settings

- 1 Press the **QUICK** button to open the Quick menu while in Single View mode or Slideshow mode.
- 2 Press the (▲/▼ arrow) buttons to select the item (**Interval Time** or **Repeat**).
- 3 Press the (◀/▶ arrow) buttons to adjust the setting.
- 4 Press the **BACK** button to return to Single View mode or Slideshow mode.

<i>Mode:</i>	<i>Description:</i>
Interval Time	Sets a time interval at which to view photos
Repeat	Displays photos in the same directory repeatedly (On/Off)

Rotate the image

While viewing the image in Single View mode or Slideshow mode, press the (▲/▼ arrow) buttons to rotate the image 90 degrees.

Return to the thumbnail

Press the **BACK** button while in Single View mode or Slide Show mode.

Display file status information

- 1 Press the **INFO** button. The information appears at the bottom of the screen.
- 2 Press the **INFO** button again to hide the information.

NOTE The information may not correctly display depending on the content or media server. Certain processes may take some time to complete.

File specifications:

USB use:

- ❖ **Data compatibility:** JPEG Exif ver 2.2
- ❖ **File format:** JPEG
- ❖ **Maximum viewable resolution:** 8192 x 16384
- ❖ **Maximum number of files:** 2000 per folder

Content on Connected Media Server:

- ❖ **Data compatibility:** JPEG EXIF Ver.1.x or later, JFIF 1.02a
- ❖ **File format:** JPEG
- ❖ **Maximum photo resolution:** 4096 x 4096
- ❖ **Maximum photo size:** 9MB
- ❖ **Maximum number of files:** 2000 per folder

NOTE If a photo resolution is larger than 1024 x 768, the photo will be resized by the server before being displayed.

Search

To search for content,

- 1 Select the search.

- 2 Enter in keywords and the search will search for:
 - ❖ Videos; Title name
 - ❖ Music; Title name/Artist name/ Album name
 - ❖ Photos; Title name
 - ❖ USB; Videos/Music/Photos; File name

NOTE Folders are not subject to the search function.

- 3 The retrieval result is displayed.
- 4 Select one of the search results.
- 5 The selected content will play.

NOTE The search retrieval stops when content is being played.

Network Device Setup

In order to set the access the External Control Setup, Media Renderer Setup, or Device Name Setup, you must use the Network Device Setup menu.

External Control Setup

- 1 Press the **MENU** button. Select **NETWORK, Network Device Setup** and press the **OK** button.
- 2 Select **External Control Setup**, and press the **OK** button.
- 3 Use the (◀/▶) arrow) buttons to select and set **Enable Control** to **On** or **Off**.

To access the Home Control Profile:

- 1 Press the **MENU** button. Select **NETWORK, Network Device Setup** and press the **OK** button to select.
- 2 Use the (◀/▶) arrow) buttons to select **Home Control Profile** and press the **OK** button.

The Home Control Profile window will appear.

- 3 Use the (▲/▼/◀/▶) arrow) buttons to navigate to the **User Name** or **Password** field. The keypad will appear so that you can enter in the user name and password. You can use the remote control keypad, the software keypad, or the USB/QWERTY keyboard to enter in the user name and password.

- ❖ To use the remote control keypad, use the remote control up/down buttons to enter the name and password, and press the **BLUE** button.
 - ❖ To use the software keyboard, press the **GREEN** button. Use the number and letter buttons to enter in the user name and password, and press the **BLUE** button to submit.
 - ❖ To use the USB/QWERTY keyboard, use the number and letter buttons to enter in the user name and password, and press the **ENTER** button to submit.
-

NOTE

Only the 0-9 and capital/lowercase A-Z characters may be used for the user name and password.

Setting up the Media Renderer feature

The TV can be configured as a Media Renderer. When operating as a Media Renderer, the TV displays content provided by a Media Server. The selection of the media is done by the Media Controller. The TV can play photo, movie, or audio files when operating as a Media Renderer.

Installation

You can configure the Media Renderer settings individually, or use Installation mode to be prompted for each setting in order.

- 1 Press the **MENU** button. Select **NETWORK, Network Device Setup**, and then press the **OK** button.
- 2 Press the (**▲/▼** arrow) buttons to select **Media Renderer Setup**, and then press the **OK** button.
- 3 Press the (**▲/▼** arrow) buttons to select **Installation**, and then press the **OK** button.
- 4 Press the (**▲/▼** arrow) buttons to select **On**, and then press the **OK** button. If you want to change the device name as a Media Renderer, highlight the **Device Name** field and press the **OK** button. The Software Keyboard screen appears.
- 5 Input the device name by using the Software Keyboard. To save your setting, press the **BLUE** button.
- 6 Select **Done**. Press the **OK** button.
- 7 If you want to limit access from unexpected Media Controllers, press the (**◀/▶** arrow) buttons to select **On**. Press the **OK** button.

- 8 If you want to proceed with registration of Media Controllers, press the (◀/▶ arrow) buttons to select **Yes**. Press the **OK** button.
- 9 Press the (▲/▼ arrow) buttons to select the MAC address of the Media Controller you want to accept. Press the **OK** button. The box is selected. To clear the selection, press the **OK** button.
- 10 Press the right arrow button to select **Done**. Press the **OK** button.
- 11 Press the (▲/▼ arrow) buttons to adjust to the desired volume. Press the **OK** button.
- 12 If you want to wake up the TV by using the Media Controller, press the (◀/▶ arrow) buttons to select **Yes**. Press the **OK** button.

Device Name setup

The device name as a Media Renderer can be changed.

- 1 Press the **MENU** button. Select **NETWORK**, **Network Device Setup**, and then press the **OK** button.
- 2 Press the (▲/▼ arrow) buttons to select **Device Name Setup**, and then press the **OK** button.
- 3 Select the **Device Name** field. Press the **OK** button. The Software Keyboard screen appears.
- 4 Input the device name by using the Software Keyboard. To save your setting, press the **BLUE** button.
- 5 Select **Done**. Press the **OK** button.

NOTE The maximum number of characters allowed for the device name is 15. Only 0-9, A - Z can be used in the device name.

Media Controller setup

You can limit which Media Controller can control this TV. If Access Control is enabled, only those Media Controllers with a check will be allowed to control the TV.

- 1 Press the **MENU** button. Select **NETWORK**, **Network Device Setup**, and then press the **OK** button.
- 2 Press the (▲/▼ arrow) buttons to select **Media Renderer Setup**, and then press the **OK** button.

- 3 Press the (▲/▼ arrow) buttons to select **Media Controller Setup**. Press the **OK** button.
 - 4 Press the (▲/▼ arrow) buttons to highlight **Access Control**. Press the (◀/▶ arrow) buttons to select **On**.
 - 5 Press the (▲/▼ arrow) buttons to select **Media Controller**. Press the **OK** button.
 - 6 Press the (▲/▼ arrow) buttons to select the MAC address of Media Controller you want to accept.
 - 7 Press the **OK** button. The box is selected. To clear the selection, press the **OK** button.
 - 8 Press the right arrow button to select **Done**. Press the **OK** button.
-

- NOTE**
- ❖ You can select up to 8 Media Controllers.
 - ❖ If you would not like to limit the Media Controllers for this TV, set Access Control to Off.
 - ❖ Devices other than Media Controller may be displayed in the list.
 - ❖ Confirm the MAC address of Media Controller and select it.
-

Maximum volume setup

This feature allows you to set the maximum volume of the TV when it receives volume operation commands from a Media Controller.

- 1 Press the **MENU** button. Select **NETWORK, Network Device Setup**, and then press the **OK** button.
 - 2 Press the (▲/▼ arrow) buttons to select **Media Renderer Setup**, and then press the **OK** button.
 - 3 Press the (▲/▼ arrow) buttons to highlight **Maximum Volume Setup**.
 - 4 Press the (◀/▶ arrow) buttons to adjust to the desired volume.
-

- NOTE** The TV's remote control can set volume regardless of the value of Maximum Volume Setup
-

Apps Control Profile

To select the Apps Control Profile

- 1 Press the **MENU** button. Select **NETWORK, Network Device Setup** and press the **OK** button.
- 2 Use the (▲/▼ arrow) buttons to select **Apps Control Profile** and press the **OK** button.
The Apps Control Profile window will appear.
- 3 Use the (▲/▼ arrow) buttons to select **Device Registration Setup** and press the **OK** button.
The Device Registration Setup window will appear.
- 4 Use the (▲/▼ arrow) buttons to highlight the **Companion Device ID**.
- 5 Select the **Cancel, All, or Delete** buttons.

To enable the New Device Detection:

- 1 Press the **MENU** button. Select **NETWORK, Network Device Setup** and press the **OK** button to select.
- 2 Use the (◀/▶ arrow) buttons to select **Apps Control Profile** and press the **OK** button.
The Apps Control Profile window will appear.
- 3 Use the (▲/▼ arrow) buttons to select **New Device Detection** and press the **OK** button.
- 4 Use the (◀/▶ arrow) buttons to select **Enable** or **Disable**.
- 5 Press the **OK** button to submit.

Toshiba A/V Remote App

The Toshiba A/V Remote App is available for compatible Toshiba equipment using compatible tablets and smartphones powered by Android™. These devices must be running the Android™ application Honeycomb or higher. You must download the Toshiba A/V Remote App through the Android™ Marketplace.

NOTE

- ❖ Third party Internet services are not provided by Toshiba, may change or be discontinued at any time and may be subject to Internet service provider restrictions. Toshiba makes no warranties, representations, or assurances about the content, availability or functionality of third-party content or services. Use of third party Internet services may require the creation of a separate account through a computer with Internet access and/or payment of one-time and/or recurring charges and membership. Not all third party services may be available on or compatible with this product. In order to experience the full suggested capabilities of this product, fully-compatible devices may be required.
 - ❖ The Toshiba A/V Remote App can only be used when your TV and your tablet or smartphone are connected to the Internet.
 - ❖ Starting and operation of this service may take several minutes.
 - ❖ Software updates may be needed in order to use this service.
 - ❖ In order to experience the full suggested capabilities of this product, fully-compatible devices may be required. Certain features may not be available in all countries.
-

Initial setup

In order to use this application, your Android™ device and compatible Toshiba equipment must be connected to the wireless LAN in your home. After downloading the Toshiba A/V Remote App, follow these steps:

- 1** Read the disclaimer and select the **Agree** option.
- 2** The Toshiba equipment's name will appear in the terminal window of the device powered by Android™.

- 3 Select the desired Toshiba equipment from the list.



(Sample Illustration) Toshiba A/V Remote App—Device Select screen

- 4 Activate the selected device by entering in the a 4-digit PIN code on the pop-up window on the tablet or smartphone. Press the **OK** button on the tablet or smartphone screen.

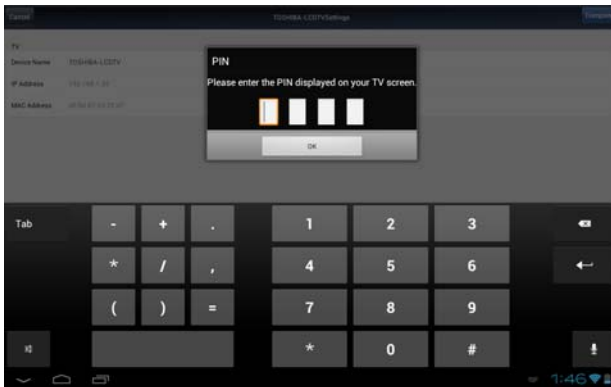

(Sample Illustration) Toshiba A/V Remote App—Input PIN code screen

Controlling devices

After the devices have been setup, you can control the compatible devices through the Toshiba A/V Remote App.

To control the devices, you should first select the type of device you wish to control from the top bar. These devices will vary depending on what devices were added. These controls are also described in [“Learning about the remote control” on page 49.](#)

The device control page will show several controls, depending on the device. Some of these controls may include:

- ❖ **Number keypad**—to enter in 0-9 digit numbers
- ❖ **INPUT**—Selects the video input source.
- ❖ **CH Up/Down**—Cycles through programmed channels.
- ❖ **APPS**—launches the apps on-screen.
- ❖ **ePORTAL**—Launches the eMANUAL application on-screen.
- ❖ **INTERNET**—Launches the web browser on-screen.
- ❖ **SEARCH**—Accesses the Search All function
- ❖ **QUICK**—Launches the Quick menu.
- ❖ **3D button**—Accesses the 3D options.
- ❖ **PIC MODE**—Selects the picture mode.
- ❖ **PIC SIZE**—Cycles through the picture sizes.
- ❖ **INFO**—displays TV status information as well as program details, when available.
- ❖ **SLEEP**—Accesses the sleep timer.
- ❖ **CC button**—Accesses the closed-caption feature.
- ❖ **Red/Green/Yellow/Blue color buttons**
- ❖ **Navigational controls**—the (▲/▼/◀/▶ arrow) buttons for on-screen menus.
- ❖ **MENU**—Accesses the main TV menu system.
- ❖ **GUIDE**—Launches the Toshiba MediaGuide application on-screen.
- ❖ **BACK** —Returns to the previous screen.
- ❖ **EXIT**—Closes on-screen menus.
- ❖ **OK**—Activates highlighted items in the main menu system.
- ❖ **Playback controls**—controls playback through Pause/Play/Record/Rewind/Skip Back/Fast Forward/Skip forward.
- ❖ **TV Control**—these buttons control the volume on the TV and its Sleep and Power functions.

In addition, the Toshiba A/V Remote App also includes a text input, mouse control and a touchpad control that allows you to use your tablet or smartphone as a touch screen



(Sample Illustration)—Toshiba A/V Remote App device control page

Text input

The text input screen displays a QWERTY keyboard on the tablet or smartphone that allows you to create text by either typing it in or using the voice to text feature on the device powered by Android™



(Sample Illustration) Toshiba A/V Remote App text input screen

Mouse control

The mouse control button allows you to control the cursor on the display while viewing the browser. The controls include:

- ❖ **Touchpad surface**—controlling the mouse through touch

- ❖ **Keyboard button**—displays the keyboard onscreen
- ❖ **Left mouse click button**—left-clicks on the selected item
- ❖ **Right mouse click button**—right-clicks on the selected item

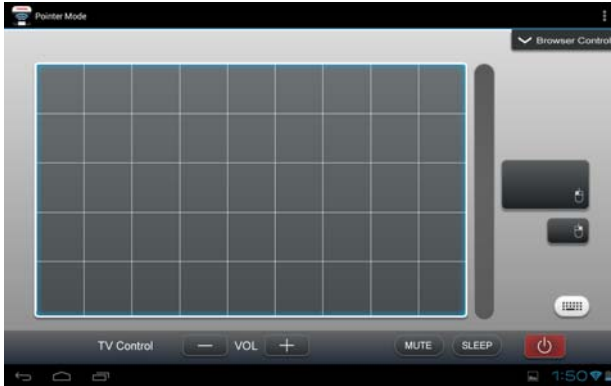

(Sample Illustration) Toshiba A/V Remote App mouse control screen

Touchpad control

The touchpad control allows you to control the screen using your finger.



(Sample Illustration) Toshiba A/V Remote App touchpad control

Combo

The Toshiba A/V Remote App also allows you to control up to four devices in one screen.

For example, you can have the controls for the TV, cable box, satellite box, and Blu-ray™ all on one screen.

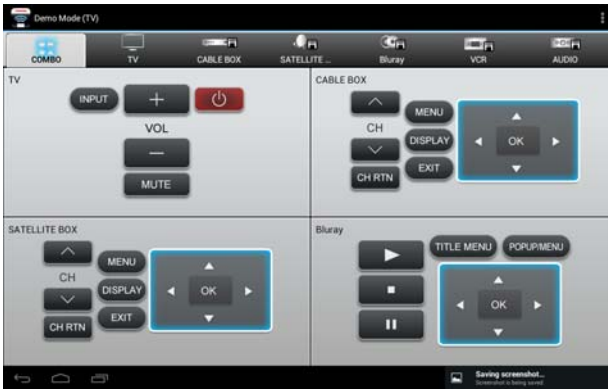

(Sample Illustration) A/V REMOTE Apps Combo screen.

Toshiba MediaGuide app

There are four screens modes which display detailed information such as TV Listings, TV Portal, Movies Portal, and Search. The screen modes can be changed using a left or right swipe of the switch bar at the top of the screen on the compatible device powered by Android™.

The switch bar contains three areas which can be selected or changed by swiping the bar.

- ❖ The first bar is the main bar that lists: TV Listings, TV Portal, Movies Portal, and Search.
- ❖ The second bar is the Genre Bar which groups items into categories such as Music, All, Favorites, etc. These groups are used to display similar content for faster browsing on the grid.
- ❖ The third bar is the date and time bar. This bar allows you to advance through the days ahead to see future programming. You can also use the **Now** and **Jump** buttons to quickly return the present time and day (**Now** button) and to advance to a future day and/or time (**Jump** button)

TV listings

In this menu the TV listings are displayed in a grid format, which is easily controlled by swiping up, down, left, and right with your finger on your Toshiba compatible device.

Popup and detailed information

When you tap or touch and hold a TV program listing, it will show more information about the selected program in a screen overlay. From this screen, you can decide whether to watch the program by selecting the **Watch** button or select the **More** button. The **More** button will bring up more details and options available for that selected item.

Genre Bar screen

You can group the TV channels list by genre and filter it by swiping the genre bar. You can select which genres display in this bar with the genre selection feature.

To change genre settings, select the **Settings** icon in upper right corner, then **EPG Settings, Genre Selection**.

If you touch and hold a channel logo, it is registered as a Favorite. The registered channel can be seen in Genre Bar Favorites.

Movies/TV portal screen

You can select from the Movie or the TV program Hotlist, their Portals, or the Reminders as desired. You can browse a list of programs that match the registered keyword in the Favorite Keywords settings.

Search screen

You can search by keyword for TV programs, movies, or names of actors for detailed information.

Detail screen

In the details screen, you can browse program and celebrity information, such as celebrities associated with a program, photos associated with a program, airing information for a specific program, programs associated with a celebrity, or photos associated with a celebrity.

Toshiba Send & Play App

The Toshiba Send & Play App allows you to share a URL from your tablet or your smartphone to your Smart TV. This app is available for compatible Toshiba equipment and compatible tablets and powered by Android™. These devices must be running the Android™ application Honeycomb or higher. You must download the Toshiba Send & Play App through the Android™ Marketplace.

NOTE

- ❖ Third party Internet services are not provided by Toshiba, may change or be discontinued at any time and may be subject to Internet service provider restrictions. Toshiba makes no warranties, representations, or assurances about the content, availability or functionality of third-party content or services. Use of third party Internet services may require the creation of a separate account through a computer with Internet access and/or payment of one-time and/or recurring charges and membership. Not all third party services may be available on or compatible with this product. In order to experience the full suggested capabilities of this product, fully-compatible devices may be required.
 - ❖ The Toshiba Send & Play App can only be used when your TV and your tablet or smartphone are connected to the Internet.
 - ❖ Starting and operation of this service may take several minutes.
 - ❖ Software updates may be needed in order to use this service.
 - ❖ In order to experience the full suggested capabilities of this product, fully-compatible devices may be required. Certain features may not be available in all countries.
-

Launching the app

In order to use this application, your Android™ device and compatible Toshiba equipment must be connected to the wireless LAN in your home. After downloading the Toshiba Send & Play App, follow these steps:

- 1 Open the web page on your tablet or smartphone using the Toshiba Send & Play app.
- 2 Select a bookmark from the list or type in the URL on the Toshiba Send & Play address bar.

- 3 Once the page has been loaded, tap the Send icon to send the website/URL to the TV.



(Sample Illustration) Toshiba Send & Play browser screen

- 4 The website/URL will automatically launch on the TV.

NOTE Some web pages or URLs may not launch, depending on the TV status.

After the web page is sent to the TV, you can use the mouse emulation screen to navigate the website.

- 1 Press the **Mouse emulation** button.
- 2 The mouse emulation screen will appear on the tablet or smartphone compatible device powered by Android™.

The mouse control screen allows you to control the cursor on the display while viewing the browser. The controls include

- ❖ **Touchpad surface**—controlling the mouse through touch
- ❖ **Keyboard button**—displays the keyboard onscreen
- ❖ **Left mouse click button**—left-clicks on the selected item
- ❖ **Right mouse click button**—right-clicks on the selected item

Text input

The text input screen displays a QWERTY keyboard on the compatible tablet or smartphone that allows you to create text by either typing it in or using the voice to text feature on the device powered by Android™.

Chapter 9

Troubleshooting

General troubleshooting

Before calling a service technician, review this chapter or visit the Toshiba technical support Web site at support.toshiba.com for possible causes/solutions for the problem you are experiencing.

Before you begin to troubleshoot any problem, first unplug the TV from the AC wall outlet, wait approximately one minute, and then plug the TV back into the AC wall outlet. If the problem still exists attempt to troubleshoot the problem.

Black box on screen.

The closed caption feature is set to one of the Text modes (**T1**, **T2**, **T3**, or **T4**). Set the closed caption feature to Off, see “Using closed captions” on page 87.

TV stops responding to controls.

If the TV stops responding to the buttons on the remote control or TV control panel and you cannot turn off the TV, press and hold POWER button on the TV control panel for several seconds to reset the TV. If the TV does not power off using this method, unplug the TV from the AC wall outlet and plug it back in.

If you cause a static discharge when touching the TV and the TV fails to function, simply unplug the TV from the AC outlet and plug it back in. The TV should return to normal operation.

Other problems.

If your TV's problem is not addressed in this Troubleshooting chapter or the recommended solution has not worked, use the Reset Factory Defaults procedure, see [“Resetting to Factory Defaults” on page 107](#).

TV will not turn on.

Ensure the power cord is plugged in properly, and then press the **POWER** button.

Replace the batteries in the remote control, see [“Installing batteries” on page 46](#).

Try the control panel buttons on the TV.

3D problems.

Watch the TV at a proper viewing angle and distance, see [“Safety Precautions for 3D glasses” on page 6](#).

If 3D images are not correct, the 3D format may be different. Change the 3D format in the Quick menu, see [“Selecting 3D format from the Quick menu in 3D mode” on page 78](#).

The left and right sides of 3D images may be reversed. Switch the left and right, see [“Switching left and right images” on page 85](#).

If 2D images are not correct, the 2D format may be different. Change the 2D format in the Quick menu, see [“Selecting 2D format from the Quick menu in 2D mode” on page 79](#).

Remove all obstructions between the 3D glasses and the TV.

If there is no power to the 3D glasses, charge the battery.

Picture problems

General picture problems.

Check the antenna/cable connections, see [“Connecting Your TV” on page 27](#).

Press the **INPUT** button on the remote control or on the TV and select a valid video input source, see [“Selecting the video input to view” on page 86](#). If no device is connected to an input on the TV, no picture appears when you select that particular input source. For device connection details, see [“Connecting Your TV” on page 27](#).

Antenna reception may be poor. Use a highly directional outdoor antenna (if applicable).

The station may be having broadcast difficulties. Try another channel.

Adjust the picture quality, see [“Using the advanced picture settings features” on page 117.](#)

If Edge Booster does not achieve a sharper picture, change the Sharpness value to increase the sharpness level, see [“Edge Enhancer” on page 117.](#)

Video Input Selection problems.

If the Input Selection window does not appear when you press the **INPUT** button on the remote control or the TV control panel, press the **INPUT** button a second time. The TV displays the next video input source and the Input Selection screen.

Cannot view external signals or channel 3 or 4.

If you cannot view signals from external devices connected to VIDEO 1, VIDEO 2, ColorStream HD1, ColorStream HD2, HDMI 1, HDMI 2, HDMI 3, HDMI 4, PC, or from channel 3 or 4, ensure that the Input Lock is set to **Off**, see [“Locking video inputs” on page 96.](#)

Poor display color or no color.

The station may be having broadcast difficulties. Try another channel.

Check the Input mode when you use Shared Inputs, see [“Configuring shared inputs” on page 70.](#)

Adjust the Tint and/or Color, see [“ColorMaster™” on page 121.](#)

Poor composite picture.

If the TV is connected to an external A/V device (e.g. DVD player, video game system, set-top box, etc.) try using a ColorStream or HDMI™ video connection instead.

Picture and sound are out of sync.

As with all products that contain a digital display, this may occur in rare instances, when viewing certain content (e.g. television broadcasts, video games, DVDs). The cause may include, without limitation, video processing within the TV, video processing in an attached gaming system, and video processing or different compression rates used by broadcasters in their programming.

Try the following:

- ❖ If the TV is connected to an A/V receiver that has a programmable audio delay feature, use this feature to help synchronize the sound to the picture.
- ❖ If the problem occurs only on certain TV channels, inform your local broadcast, cable, or satellite provider.

- ❖ The settings of Side Shared Audio and Rear Shared Audio may be not correct. Check the connections, see [“Connecting a digital audio system” on page 34](#).
- ❖ Turn off and unplug the TV from the AC wall outlet for a few seconds and plug it back in.

Sound problems

Check the antenna/cable connections, see [“Connecting a digital audio system” on page 34](#).

The station may be having broadcast difficulties. Try another channel.

The sound may be muted. Press the **VOL (+ -)** buttons.

If you connect a computer using either the PC IN terminal or an HDMI® terminal, make sure that the Rear Shared Audio setting is properly set, see [“Connecting a digital audio system” on page 34](#).

Remote control problems

Ensure that the remote control is set to the correct device mode, see [“Learning about the remote control” on page 49](#).

Remove all obstructions between the remote control and the TV.

Replace the remote control’s batteries, see [“Installing batteries” on page 46](#).

Your TV’s remote control may not operate certain features on your external device. Refer to the owner’s manual for your other device to determine its available features. If your TV remote control does not operate a specific feature on another device, use the remote control that came with the device, see [“Learning about the remote control” on page 49](#).

If the TV still does not act as expected, perform the Reset Factory Defaults procedure, see [“Resetting to Factory Defaults” on page 107](#).

Channel tuning problems

Ensure that the remote control is set to the correct device mode, see [“Learning about the remote control” on page 49](#).

The Auto Tuning feature may have erased the channel from memory. Add the channel to the channel memory, see [“Using SurfLock™” on page 85](#).

The Lock feature may have blocked the channel. Unblock the channel, see [“Using SurfLock™” on page 85](#).

If you cannot tune digital channels, check the antenna configuration, see [“Initial setup” on page 51](#). If the problem persists, clear all channels from the channel list and reprogram channels into memory, see [“Storing channels in memory \(optional\)” on page 66](#). For additional information, see [“TV stops responding to controls.” on page 181](#). If the problem persists, use the Reset Factory Defaults procedure, see [“Resetting to Factory Defaults” on page 107](#).

Closed caption problems

If the program or video you have selected is not closed captioned, no captions appear on the screen.

If text is not available, a black rectangle may appear. If this happens, turn off the closed caption feature, see [“Using closed captions” on page 87](#).

A closed caption signal may not display correctly under the following circumstances:

- ❖ The recording is dubbed
- ❖ The signal reception is weak
- ❖ The signal reception is nonstandard

For additional information, see [“Using closed captions” on page 87](#).

Rating blocking (V-Chip) problems

Forgotten PIN code.

When the PIN code screen appears, press the **INFO** button 4 times within approximately 5 seconds. The old PIN code is cleared, see [“Forgotten PIN code” on page 91](#).

The V-Chip feature is available for U.S. V-Chip systems only, see [“Using parental controls” on page 91](#).

HDMI[®] CEC Control operation

HDMI[®] CEC Control feature is available for Toshiba HDMI[®] CEC compatible devices.

HDMI[®] cables.

Ensure that HDMI[®] cables with the (**HDMI**) Logo are used.

The HDMI[®] CEC operation is not working correctly.

When the connected HDMI[®] CEC device does not work correctly after you have changed the device's settings, turn off the TV and

unplug the power cord. After approximately one minute, plug the power cord in and turn on the TV.

If several devices are connected, the HDMI® CEC Control feature may not operate properly.

Read the instruction manual of the connected HDMI® CEC device.

HDMI® problems

HDMI® cables.

Ensure that HDMI® cables with the (**HDMI**) Logo are used, see [“Connecting an HDMI® or DVI device to the HDMI® input”](#) on page 35.

Network problems

Cannot connect to the Internet.

Check the modem and its incoming cable/telephone connections, see [“Connecting to a home network”](#) on page 42.

Confirm your modem’s operation.

Ensure your IP address is set up correctly.

No network connection.

If using a wired network connection, check to ensure that the LAN cables are connected properly, see [“Connecting the TV to a home network with an Internet connection - wired”](#) on page 43.

Ensure that the modem and router power cords are plugged in and the devices are operating properly.

Ensure that your IP address is set up correctly, see [“IP Address Setup”](#) on page 136.

Check to ensure proper operation of other network connected devices.

Network Setup fails (Auto).

Check to ensure that the LAN cables are connected properly, see [“Connecting the TV to a home network with an Internet connection - wired”](#) on page 43.

DHCP is not enabled on the router, or no router is present. Refer to your router’s documentation for instructions on enabling DHCP. If your router does not support DHCP, you must manually set up the IP address.

Internet service is not available. Check your cable/DSL modem or contact your ISP for Internet service issues.

Network Setup fails (Manual).

Ensure that the TV IP address is not the same as any other device on the network.

- ❖ Example: IP address 192.168.0.100 and IP address 192.168.0.101 are different addresses on the same network.

Make sure the TV IP address is on the same subnet as the networked computer.

- ❖ Example of proper setup: The computer has the IP address 192.168.0.100 with the Subnet mask 255.255.255.0, the TV has the IP address 192.168.0.101 with the Subnet mask 255.255.255.0; both are on the same subnet.
- ❖ Example of improper setup: The computer has the IP address 192.168.1.100 with the Subnet mask 255.255.255.0, the TV has the IP address 192.168.0.101 with the Subnet mask 255.255.253.0; they are on different subnets.

Unstable network connection.

When using a wired home network connection, unplug the LAN cables, and then reconnect them.

When using a wireless home network connection:

- ❖ Reboot the router:
 - 1 Remove AC power from the router and the television for approximately one minute.
 - 2 Reconnect AC power to the router.
 - 3 Reconnect AC power to the television and turn it On.
 - 4 After approximately two minutes, check connection stability.
- ❖ Connect with LAN cables, if possible, and check connection stability.
- ❖ Repeat the wireless network setup procedure and check connection stability.

The media server name is not displayed.

The LAN cables, if used, are not connected properly, see [“Connecting the TV to a home network with an Internet connection - wired”](#) on page 43.

The WLAN, if used, is not configured properly.

The network setup on the Server is incorrect. Make sure both the media server and TV are using the same network type (DHCP/manual) and have compatible network settings.

Too many devices are connected. You cannot connect more than 32 sharing devices at one time.

The media server is not turned On.

The “server” is not a media server device.

Check the firewall and streaming settings on the media server.

Wireless network problems

Check that the router/AP (Access point) power is On.

After starting wireless network setup, confirm that the network is configured properly by performing the network connection test, see “[Network Connection Test](#)” on page 139.

Check the router/AP’s connection status.

If the router/AP does not support PBC or WPS, Easy Setup (PBC) will not work even if the push-button is pressed, see “[Wireless Setup](#)” on page 131.

If the available router/AP list is not displayed in Easy Setup (PBC) or Assisted Setup, the power of the router/AP may be Off. Check that it is On, and then try restarting the scan for available routers/APs, see “[Easy Setup using PBC \(Push button configuration\)](#)” on page 131.

Refer to the router/AP’s instruction manual.

MediaShare (Media Player) problems

Ensure that the devices (Display and Server) are connected correctly.

Incorrect functionality may occur when using a USB HUB connection.

Photo files that were processed and edited using the computer’s application software may not be viewable.

When viewing content that supports two or more formats the display may select one format automatically.

Copyright protected content stored on the media server may not be playable on the display.

Content playback stability may be affected by heavy network traffic.

Content originally recorded on a computer may not play correctly. Set the media sharing of the media server to the correct settings, according to the media server instruction manual.

Confirm that the contents of either the media server or the USB storage device are in formats that are supported by this TV, see [“MediaShare \(Media Player\) specifications” on page 157](#).

Depending on the media server, access may be limited by the MAC address. Set the server according to the media server’s instruction manual. This TV’s MAC Address can be confirmed in the Network Setup portion of the User Menu, see [“MAC Address” on page 138](#).

For Connected MediaShare (Media Player)

Depending on the media server, it may take time to display the list.

Media Renderer

Depending the state of this TV, Media Controller may not be able to control a Media Renderer playback.

If Media Renderer playback starts regardless of the user's intention, check the access control of Media Renderer or set Media Renderer to Off.

If you use a wireless access point without encryption, there is the risk that your Media Renderer device could be controlled by an unknown Media Controller. You can protect your Media Renderer device by going to **NETWORK> Network Device Setup> Media Renderer Setup> Media Controller Setup** and limit the authorized Media Controller devices, see [“Media Controller setup” on page 170](#).

Light Indicator

The Power light on the front of the TV indicates the TV’s status, as described below.

Power On/Standby light

Green:

- ❖ The TV is On and operating properly.

No light:

- ❖ The power is Off or in Standby.

Green flashing:

- ❖ The system is booting. The screen appears after a short wait.
- ❖ The fan has stopped. Turn off the TV and unplug the power cord. After approximately one minute, plug the power cord in again and turn on the TV.

Red flashing:

- ❖ **Power On failure.** Turn off the TV and unplug the power cord. After approximately one minute, plug the power cord in again and turn on the TV.

If the problem persists after trying the solutions

In the U.S., visit TAIS Consumer Solutions on the web at support.toshiba.com or call 800-631-3811.

In Canada, locate the nearest Toshiba authorized service depot. Visit www.toshiba.ca; click “Home Entertainment,” and then click “Support.”

Appendix A

Specifications

-
- NOTE**
- ❖ This model complies with the specifications listed below.
 - ❖ Designs and specifications are subject to change without notice.
 - ❖ This model may not be compatible with features and/or specifications that may be added in the future.
-

Television system

NTSC standard	
ATSC standard	8VSB
Digital Cable	64 QAM, 256 QAM; in-the-clear, unencrypted

Channel coverage

VHF	2 through 13
UHF	14 through 69
Cable TV	Mid band (A-8 through A-1, A through I)
	Super band (J through W)
	Hyper band (AA through ZZ, AAA, BBB)
	Ultra band (65 through 94, 100 through 135)

Power source

120 V AC, 60 Hz

Power consumption

42L6200U	0.8 A (maximum current)
	0.3 W in Standby mode
47L6200U	0.9 A (maximum current)
	0.3 W in Standby mode
55L6200U	1.0 A (maximum current)
	0.3 W in Standby mode
47L7200U	1.2 A (maximum current)
	0.3 W in Standby mode
55L7200U	1.4 A (maximum current)
	0.3 W in Standby mode

Audio power

42L6200U	10 W + 10 W
47L6200U	10 W + 10 W
55L6200U	10 W + 10 W
47L7200U	10 W + 10 W
55L7200U	10 W + 10 W

Speaker type

42L6200U	Tweeter 8.2cm x 3.4cm (3 1/4 x 1 1/3 inch) x 2 pcs
	Woofer 3.9cm x 1.6cm (1/12 x 3/5 inch) x 2 pcs
47L6200U	Tweeter 8.2cm x 3.4cm (3 1/4 x 1 1/3 inch) x 2 pcs
	Woofer 3.9cm x 1.6cm (1/12 x 3/5 inch) x 2 pcs
55L6200U	Tweeter 8.2cm x 3.4cm (3 1/4 x 1 1/3 inch) x 2 pcs
	Woofer 3.9cm x 1.6cm (1/12 x 3/5 inch) x 2 pcs
47L7200U	Tweeter 8.2cm x 3.4cm (3 1/4 x 1 1/3 inch) x 2 pcs
	Woofer 3.9cm x 1.6cm (1/12 x 3/5 inch) x 2 pcs
55L7200U	Tweeter 8.2cm x 3.4cm (3 1/4 x 1 1/3 inch) x 2 pcs
	Woofer 3.9cm x 1.6cm (1/12 x 3/5 inch) x 2 pcs

Video/audio terminals

Video/audio input

Video	1 V (p-p), 75 ohm, negative sync.
Audio	200 mV (rms) (-20dBFS)

ColorStream® (component video) HD input

Video	Y: 1V (p-p), 75 ohm
	Pr: 0.7V (p-p), 75 ohm
	Pb: 0.7V (p-p), 75 ohm
	Suggested formats: 1080i, 720p, 480p, 480i
Audio	200 mV (rms) 22 k ohm or greater

HDMI® input

HDMI® compliant	
HDCP compliant	
Suggested formats	See table on page 195
HDMI® Audio	Dolby® Digital and 2-channel Linear-PCM; 32/44.1/48 kHz sampling frequency; 16/20/24 bits per sample

Digital audio output

Optical type

PC input

15-Pin D-sub Analog RGB

Wireless connection

Standard	IEEE 802.11a/b/g/n/
Host Interface	USB 2.0 compatible
Frequency Range	5.15-5.35 GHz, 5.47-5.725 GHz, 5.725-5.850 GHz, 2.400-2.473 GHz
Security	WEP 64/128, TKIP, AES, WPA/WPA2-PSK, WPS, None

Ethernet

IEEE 802.3.

USB

Universal Serial Bus Specification, Revision 1.1.

Universal Serial Bus Specification, Revision 2.0.

Dimensions (include foot stand)

42L6200U	Width	37.59" (954.7 mm)
	Height	24.85" (631.1 mm)
	Depth	8.43" (214.12 mm)
47L6200U	Width	41.90" (1064.2 mm)
	Height	27.39" (695.7 mm)
	Depth	9.25" (234.9 mm)
55L6200U	Width	48.59" (1234.1 mm)
	Height	31.30" (795 mm)
	Depth	11.29" (286.7 mm)
47L7200U	Width	41.90" (1064.2 mm)
	Height	27.39" (695.7 mm)
	Depth	9.25" (234.9 mm)
55L7200U	Width	48.59" (1234.1 mm)
	Height	31.30" (795mm)
	Depth	11.33" (287.7 mm)

Mass (weight)

42L6200U	29.54 lbs (13.3 kg)
47L6200U	35.93 lbs (16.2 kg)
55L6200U	51.59 lbs (23.4 kg)
47L7200U	37.48 lbs (17 kg)
55L7200U	55.56 lbs (25.2 kg)

Operating conditions

Temperature	32° - 95° F (0° - 35° C)
Humidity	20 - 80% (no moisture condensation)

Supplied accessories

- ❖ Remote control with two size “AA” batteries
 - ❖ L7200U model number: CT-90395
 - ❖ L6200U model number: CT-90408
- ❖ Resource Guide
- ❖ Pedestal and hardware
- ❖ Warranty
- ❖ Wireless QWERTY keyboard (2x AAA batteries)
- ❖ IR blaster cable
- ❖ AV adapter cables
- ❖ Component adapter cable
- ❖ Four pairs of 3D glasses

NOTE

The USB QWERTY keyboard supplied with this TV is a standard U.S. layout keyboard. The accented characters for French and Spanish may not be available in certain cases.

Acceptable signal formats for PC IN, HDMI[®], and 3D

PC IN signal formats

NOTE

- ❖ The PC IN on this TV only accepts signal formats which are compliant with VESA-DMT as in the table below. Since some PCs input signals are different from the resolution and frequency described in the table below, the following problems may occur: incorrect display, false format detection, picture position failure, blur, or judder. In these cases, set the monitor output format on your computer to conform to any of the signals in the table below.
 - ❖ The signals whose vertical frequency is 56 Hz, 70 Hz, 72 Hz, or 75 Hz are converted to a 60 Hz signal.
 - ❖ When you connect a computer to this TV, it is recommended that you set the refresh rate of your computer to 60 Hz.
 - ❖ The PC IN on this TV does not accept the Sync on Green, Composite Sync, and Interlace signals.
-

Format	Resolution	V. Frequency	H. Frequency	Pixel Clock Frequency	VESA Standard (DMT)
VGA	640 x 480	59.940/60 Hz	31.469/31.500 kHz	25.175/25.200 MHz	TBD
		72.809 Hz	37.861 kHz	31.500 MHz	TBD
		75.000 Hz	37.500 kHz	31.500 MHz	TBD
SVGA	800 x 600	56.250 Hz	35.156 kHz	36.000 MHz	TBD
		60.317 Hz	37.879 kHz	40.000 MHz	TBD
		72.188 Hz	48.077 kHz	50.000 MHz	TBD
		75.000 Hz	46.875 kHz	49.500 MHz	TBD
XGA	1024 x 768	60.004 Hz	48.363 kHz	65.000 MHz	TBD
		70.069 Hz	56.476 kHz	75.000 MHz	TBD
		75.029 Hz	60.023 kHz	78.750 MHz	TBD
WXGA	1280 x 768	59.995 Hz	47.396 kHz	68.250 MHz	TBD
		59.870 Hz	47.776 kHz	79.500 MHz	TBD
		74.893 Hz	60.289 kHz	102.250 MHz	TBD
	1360 x 768	60.015 Hz	47.712 kHz	85.500 MHz	TBD
SXGA	1280 x 1024	60.020 Hz	63.981 kHz	108.000 MHz	TBD
		75.025 Hz	79.976 kHz	135.000 MHz	TBD

HDMI® signal formats

NOTE

- ❖ The HDMI® inputs on this TV only accept VGA, SVGA, XGA, WXGA, and SXGA signal formats which are compliant with VESA-DMT as in the table below. Since some computer, HDMI®, or DVI device input signals are different from the resolution and frequency described in the table below, the following problems may occur: incorrect display, false format detection, picture position failure, blur, or judder. In these cases, set the monitor output format on your computer, HDMI®, or DVI device to conform to any of the signals in the table below.
- ❖ The signals whose vertical frequency is 24 Hz, 56 Hz, 70 Hz, 72 Hz, or 75 Hz are converted to a 60 Hz signal.
- ❖ When you connect a computer to this TV, it is recommended that you set the refresh rate of your computer to 60 Hz.

<i>Format</i>	<i>Resolution</i>	<i>V. Frequency</i>	<i>H. Frequency</i>	<i>Pixel Clock Frequency</i>	<i>VESA Standard (DMT)</i>
VGA	640 x 480	59.940 Hz	31.469 kHz	25.175 MHz	TBD
		72.809 Hz	37.861 kHz	31.500 MHz	TBD
		75.000 Hz	37.500 kHz	31.500 MHz	TBD
SVGA	800 x 600	56.250 Hz	35.156 kHz	36.000 MHz	TBD
		60.317 Hz	37.879 kHz	40.000 MHz	TBD
		72.188 Hz	48.077 kHz	50.000 MHz	TBD
		75.000 Hz	46.875 kHz	49.500 MHz	TBD
XGA	1024 x 768	60.004 Hz	48.363 kHz	65.000 MHz	TBD
		70.069 Hz	56.476 kHz	75.000 MHz	TBD
		75.029 Hz	60.023 kHz	78.750 MHz	TBD
WXGA	1280 x 768	59.995 Hz	47.396 kHz	68.250 MHz	TBD
		59.870 Hz	47.776 kHz	79.500 MHz	TBD
		74.893 Hz	60.289 kHz	102.250 MHz	TBD
	1360 x 768	60.015 Hz	47.712 kHz	85.500 MHz	TBD
	SXGA	1280 x 1024	60.020 Hz	63.981 kHz	108.000 MHz
75.000 Hz			79.976 kHz	135.000 MHz	TBD
480i	720 x 480i	59.940/60 Hz	15.734/15.750 kHz	27.000/27.027 MHz	TBD
480p	720 x 480p	59.940/60 Hz	31.469/31.500 kHz	27.000/27.027 MHz	TBD
720p	1280 x 720p	59.940/60 Hz	44.955/45.000 kHz	74.176/74.250 MHz	TBD
1080i	1920 x 1080i	59.940/60 Hz	33.716/33.750 kHz	74.176/74.250 MHz	TBD
1080p	1920 x 1080p	23.976/24 Hz	26.973/27.000 kHz	74.176/74.250 MHz	TBD
		59.940/60 Hz	67.433/67.500 kHz	148.352/ 148.500 MHz	TBD

3D Signal formats*

<i>Resolution</i>	<i>Aspect ratio</i>	<i>V. Frequency</i>	<i>H. Frequency</i>	<i>Pixel Clock Frequency</i>	<i>3D Structure</i>
1280 x 720p	16:9	23.98 Hz	17.98 kHz	59.341 MHz	Side by Side (half) Top and Bottom
			29.97 Hz	22.48 kHz	74.176 MHz
		59.940/60 Hz	90.0/89.91 kHz	148.352/148.500 MHz	Frame Packing
			44.955/45.000 kHz	74.176/74.250 MHz	Side by Side (half) Top and Bottom
1920 x 1080i	16:9	59.940/60 Hz	33.716/33.750 kHz	74.176/74.250 MHz	Side by Side (half) Top and Bottom
1920 x 1080p	16:9	23.976/24 Hz	54/53.94 kHz	148.352/148.500 MHz	Frame Packing
			26.973 kHz	74.176/74.250 MHz	Side by Side (half) Top and Bottom
		29.97/30 Hz	67.5/67.43 kHz	148.352/148.500 MHz	Frame Packing
			33.716/33.75 kHz	74.176/74.250 MHz	Side by Side (half) Top and Bottom
		59.940/60 Hz	67.433/67.500 kHz	148.352/148.500 MHz	Side by Side (half) Top and Bottom

*Some content may not be supported depending on the input source format.

Operating the TV with combination buttons

You can directly operate the TV power, input switch, picture size switch, and picture mode switch by pressing a combination button while holding down a color button.

<i>Button Color</i>	<i>Combination Button</i>	<i>Behavior/Mode</i>
RED	3D	Power Off
	POWER	Power On
	1	Input 1
	2	Input 2
	3	Input 3
	4	Input 4
	5	Input 5
	6	Input 6
	7	Input 7
	8	Input 8
	9	Input 9
	0	Input 10
	MUTE	Mute On
GREEN	1	Native (picture size)
	2	4:3 (picture size)
	3	TheaterWide 1 (picture size)
	4	TheaterWide 2 (picture size)
	5	TheaterWide 3 (picture size)
	6	Full (picture size)
	7	Normal (picture size)
	8	Dot by Dot (picture size)
		MUTE

<i>Button Color</i>	<i>Combination Button</i>	<i>Behavior/Mode</i>
YELLOW	1	AutoView (picture mode)
	2	Dynamic (picture mode)
	3	Standard (picture mode)
	4	Movie (picture mode)
	5	- (picture mode)
	6	Store (picture mode)
	7	Game (picture mode)
	8	PC (picture mode)
	MUTE	Mute Off

Index

Numerics

3D

- 2D from Quick menu 79
- 3D from Quick menu 78
- 3D lock 83
- 3D timer lock 83
- adjusting 2D to 3D depth 84
- auto start mode 81
- button operation 76
- change pin code 82
- delete pin code 82
- enable 3D timer 83
- enter new pin code 81
- forgotten pin code 82
- functions 74
- Native mode 80
- selecting format 76
- setting 3D pin code 81
- start message 82
- switch left right images 85
- switching display mode 76
- switching to 2D mode 79
- switching to 3D mode 77
- viewing images 72

- 4/3 stretch
using 114

A

- advanced picture settings
 - Auto Brightness Sensor 120
 - Backlight Adjustment Pro 120
 - Base Color Adjustment 121
 - Color temperature 122
 - ColorMaster™ 121
 - DNR 119
 - DynaLight® 118
 - Dynamic Contrast 117
 - Edge Enhancer 117
 - MPEG NR 119
 - resetting to factory default 122
 - Static Gamma 118
 - using 117
- Apps Control Profile 171
- audio
 - adjusting balance 125
 - adjusting range 126
 - Audyssey Dynamic Volume®
127
 - bass/treble 126

- Dolby® Digital Dynamic Range Control 126
- muting sound 125
- optical audio output format 126
- Auto Aspect
 - using 114
- auto input
 - features 70
- C**
- cables
 - 3.5mm to RCA Y-cable 29
 - analog RGB (15-pin) 29
 - coaxial (F-type) 27
 - component video (red/green/blue) 28
 - Dual-wand IR blaster cable 29
 - HDMI® 28
 - LAN 30
 - optical audio 29
 - overview of cables 27
 - standard A/V (red/white/yellow) 27
- channel return 85
- channels
 - auto tuning 66
 - labeling analog TV channels 69
 - labeling video inputs 70
 - locking specific channels 95
 - manual tuning 67
 - next programmed channel 85
 - skipping 68
 - skipping video inputs 68
 - specific channel 85
 - storing in memory 66
- closed captions
 - Analog CC mode 87
 - button 90
 - Digital CC settings 89
 - using 87
- computer
 - adjusting image 102
 - setting the audio 103
 - to the TV's HDMI® 41
 - using with the TV 102
- connecting
 - a computer 39
 - audio system 35
 - cable TV 30
 - camcorder 30
 - computer to TV's PC IN 39
 - DVD player with ColorStream® 31
 - DVI device to HDMI® input 36
 - HDMI® audio system 39
 - HDMI® device to HDMI® input 36
 - IR devices 33
 - satellite receiver 31
 - to a computer (no Internet connection) 43
 - to a home network 42
 - to a home network (no Internet connection) 43
 - to a home network (wired Internet connection) 44
 - to a home network (wireless Internet connection) 44
 - TV's HDMI® 41
 - VCR 31
 - VCR and antenna 30
- control other devices
 - HDMI®-CEC Control 38
- control panel
 - lock 97
- controlling other devices
 - TV remote 38
- E**
- ePORTAL 142
 - add favorites 152
 - Apps 144
 - create event 151
 - create messages 151

- delete event 151
- editing favorite apps 152
- events 151
- MediaShare 157
- modify favorites 152
- preferences 153
- search 143
- select apps 144
- view favorites 152

ePortal 142

ePORTAL Internet 147

- access web page 150
- adding favorites 150
- browsing favorites 149

expert picture settings

- RGB Filter 123
- setting 122
- Test Pattern 122
- White Balance 123

External Control Setup 167

F

Factory Defaults

- reset 107

favorites

- adding 150
- browsing 149
- viewing 152

features 21

H

HDMI®

- viewing signal information 102

HDMI® CEC

- adjusting amplifier's audio 100
- controlling playback devices 98
- input source selection 100
- other functions 101

HDMI® CEC Control

- using 97

HDMI® settings feature

- using 101

home network

using 129

I

icon

- safety 20

initial settings

- change 64

- individual settings 65

- navigate the menu 64

- quick setup 64

initial setup 51

- main menu layout 62

- menu navigation 61

- quick menu 63

IR Blaster Out terminal

- using 33

IR Blaster setup 55

M

Media Renderer

- device name setup 169

- maximum volume setup 170

- Media Controller setup 170

MediaGuide 153

- operating 154

- setup 153

MediaShare (Media Player)

- basic operation 158

- playing music files 162

- specifications 157

- viewing movie files 160

- viewing photo files 164

Music

- access via ePORTAL 157

N

network

- advanced setup 136

- connection test 139

- DNS setup 137

- initial setup 58

- setup 131

- wireless setup 131

Network Device Setup 167

no signal power down

set 106

O

overview

installation 22

setup 22

use 22

P

parental controls

blocking programs/movies by

rating (V-Chip) 91

using 91

Photos

access via ePORTAL 157

picture

adjusting 115

adjusting quality 115

picture mode

selecting 115

picture settings

locking 124

picture size

4/3 111

Dot by Dot 113

Full 111

Native 110

Normal 113

selecting 109

TheaterWide 1 112

TheaterWide 2 112

TheaterWide 3 112

pin code

changing 91

deleting 91

entering new pin code 91

forgotten 91

setting pin code 90

power failure 108

program ratings

displaying 95

unlocking programs 95

Q

quick setup

ANT/CABLE IN 66

local time 65

location 65

menu language 65

R

rating system 93

downloading additional 92

S

safety

icons 20

scrolling the picture 113

shared inputs

configuring 70

SmartTV

using 142

YouTube™ 146

SmartTV™

CinemaNow® 147

Netflix 144

VUDU™ 145

software keyboard

using 139

software licenses

show 141

software upgrade

performing 140

specifications

3D Signal formats 198

acceptable signal formats 195

audio power 192

channel coverage 191

ColorStream® HD input 193

Digital audio output 193

dimensions 194

ethernet 194

HDMI® input 193

HDMI® signal formats 196

- mass (weight) 194
- operating conditions 194
- PC IN signal formats 195
- PC input 193
- power consumption 192
- power source 192
- remote, combination buttons 199
- speaker type 192
- supplied accessories 195
- TV system 191
- USB 194
- video/audio terminals 193
- wireless connection 193
- support information
 - show 107
- SurfLock™
 - using 85
- T**
- time limit
 - set for games 96
- timer
 - sleep timer 105
 - turn on TV 104
- Toshiba A/V Remote App
 - Combo 176
 - controlling devices 173
 - initial setup 172
 - mouse control 175
 - text input 175
 - Toshiba MediaGuide app 177
 - touchpad control 176
- Toshiba MediaGuide app 177
 - detail screen 178
 - Genre Bar 178
 - movie/TV portal 178
 - popup, detailed information 178
 - search 178
 - TV listings 177
- Toshiba Send & Play App 178
 - launching 179
 - text input 180
- troubleshooting 181
 - channel tuning problems 184
 - closed caption problems 185
 - contact Toshiba 190
 - HDMI® 186
 - HDMI® CEC Control problems 185
 - light indicator 189
 - light indicator functions 189
 - MediaShare (Media Player) problems 188
 - network problems 186
 - picture problems 182
 - Rating blocking problems 185
 - remote control problems 184
 - sound problems 184
 - wireless network problems 188
- TV connections
 - front 23
 - side 23
- TV panel connections
 - back 24
- TV panel controls
 - front 23
 - left side 23
 - side 23
- TV remote
 - control other devices 46
 - effective range 48
 - functionality 49
 - install batteries 46
- TV status information
 - show 106
- V**
- Video
 - access via ePORTAL 157
- video input
 - locking 96
 - selecting 86
- W**
- web browser 147

access web page 150

adding favorites 150

browsing favorites 149