

TOSHIBA/HOUSTON TOTALLY-ENCLOSED FAN-COOLED
HORIZONTAL FOOT-MOUNTED

Fr. 5010USS
2-POLE

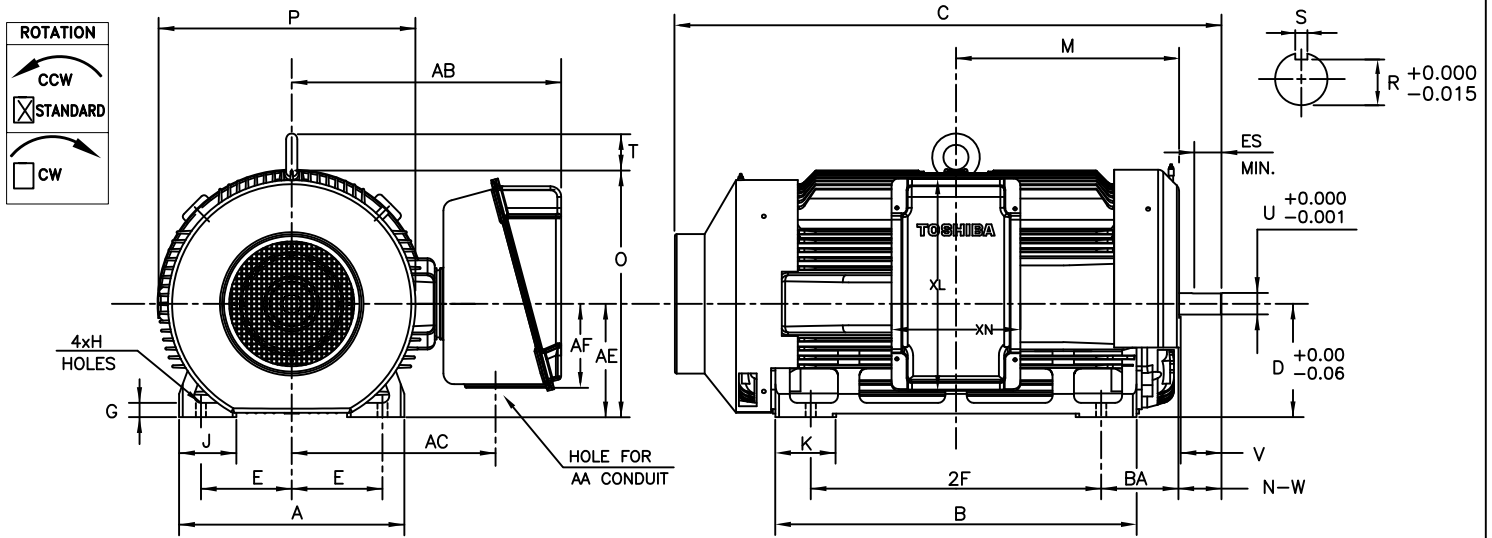

UNITS: INCHES

FRAME SIZE	MOUNTING				CONDUIT BOX						
	E	2F	H	BA	AA[NPT]	AB	AC	AE	AF	XL	XN
5010USS	10.00	32.0	1.12	8.50	4.00	29.7	22.5	12.5	9.3	23.4	14.2

FRAME SIZE	MOTOR DIMENSIONS										
	A	B	C	D	G	J	K	M	O	P	T
5010USS	24.8	39.8	60.2	12.50	1.6	6.3	6.7	24.6	27.2	28.4	4.3

FRAME SIZE	SHAFT EXTENSION			KEY SEAT			BEARINGS		MAXIMUM WEIGHT
	N-W	V	U	R	S	ES	LS	OS	
5010USS	4.75	4.50	2.375	2.021	0.625	3.03	6313C3	NU313C3	4300 lbs.

NOTES:

- DIMENSION V REPRESENTS LENGTH OF STRAIGHT PART OF SHAFT.
- CONDUIT BOX MAY BE ROTATED IN 90° INCREMENTS AND MAY BE MOUNTED ON OPPOSITE SIDE ON SPECIAL ORDER.
- KEY DIMENSIONS EQUAL S x S x 3.00 (MOTOR SUPPLIED WITH KEY)
- MOTOR WEIGHT SHOWN IS MAXIMUM HORSEPOWER IN FRAME.
- STANDARD UNITS USE UNI-DIRECTIONAL FAN. OPPOSITE ROTATION AVAILABLE ONLY BY FAN AND CONNECTION CHANGE.

ALL DATA SUBJECT TO CHANGE WITHOUT NOTICE.
FOR CONSTRUCTION USE ONLY CERTIFIED DATA.

CERTIFIED DATA

CUSTOMER: _____ P.O. NO.: _____ TAG NO.: _____

MOTOR MODEL NO.: _____ TOSHIBA FILE NO.: _____

HP: _____ RPM (SYN.): _____ VOLTAGE: _____ Hz: _____

FRAME SIZE: _____ LOG NO.: _____ LOG REV. LEVEL: _____

REMARKS: _____

PER: _____ ISSUE DATE: _____ SUPERSEDES: _____

TYPICAL MOTOR PERFORMANCE DATA

Model: B3001FLG8BMH

HP	kW	Pole	FL RPM	Frame	Voltage	Hz	Phase	FL Amps
300	224	2	3580	5010USS	460	60	3	321
Enclosure	IP	Ins. Class	S.F.	Duty	NEMA Nom. Eff.	NEMA Design	kVA Code	Ambient (°C)
TEFC	54	F	1.15	CONT	95.8	B		40 C

Load	HP	kW	Amperes	Efficiency (%)	Power Factor (%)
Full Load	300.00	223.7	321	96.4	90.7
¾ Load	225.00	167.8	245	95.5	89.7
½ Load	150.00	111.9	173	93.6	86.4
¼ Load	75.00	55.9	108	88.1	73.3
No Load			61.0		15.4
Locked Rotor			2200		22.2

Torque				Rotor wk ² Inertia (lb-ft ²)
Full Load (lb-ft)	Locked Rotor (% FLT)	Pull Up (% FLT)	Break Down (% FLT)	
440	155	105	265	117.40

Safe Stall Time(s)		Sound Pressure dB(A) @ 1M	Bearings*		Approx. Motor Weight (lbs)
Cold	Hot		DE	NDE	
21	11	-	6313C3	NU313C3	4200

*Bearings are the only recommended spare part(s).

Motor Options:
Product Family:EQP Global SD
Mounting:Footed,Shaft:USS Shaft

Customer	
Customer PO	
Sales Order	
Project #	

Tag:

All characteristics are average expected values.

TOSHIBA INTERNATIONAL CORPORATION · HOUSTON, TEXAS U.S.A.

Engineering	zxie	Doc. Written By	D. Suarez	Doc.# / Rev	MPCF-1119 / 0
Engr. Date	3/30/2021	Doc. Approved By	M. Campbell	Doc. Issued	6/8/2011

SPEED TORQUE/CURRENT CURVE

Model: B3001FLG8BMH

HP	kW	Pole	FL RPM	Frame	Voltage	Hz	Phase	FL Amps
300	224	2	3580	5010USS	460	60	3	321
Enclosure	IP	Ins. Class	S.F.	Duty	NEMA Nom. Eff.	NEMA Design	kVA Code	Ambient (°C)
TEFC	54	F	1.15	CONT	95.8	B		40 C
Locked Rotor Amps	Rotor wk ² Inertia (lb-ft ²)	Torque						Break Down (%)
		Full Load (lb-ft)	Locked Rotor (%)	Pull Up (%)				
2200	117.40	440	155	105			265	

Design Values

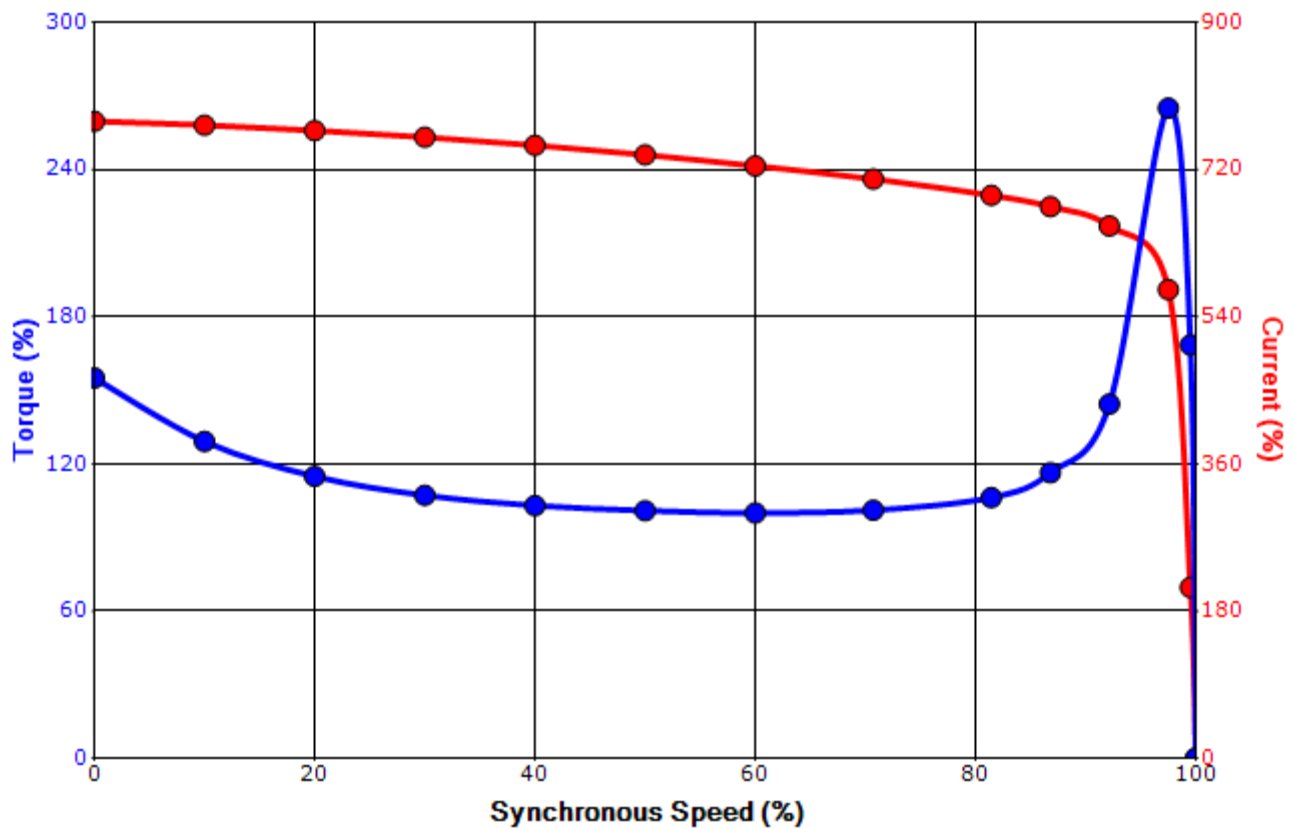

Customer		wk ² Load Inertia (lb-ft ²)	-
Customer PO		Load Type	-
Sales Order		Voltage (%)	100
Project #		Accel. Time	-

Tag:

All characteristics are average expected values.

TOSHIBA INTERNATIONAL CORPORATION · HOUSTON, TEXAS U.S.A.

Engineering	zxie	Doc. Written By	D. Suarez	Doc.# / Rev	MPCF-1121 / 0
Engr. Date	3/30/2021	Doc. Approved By	M. Campbell	Doc. Issued	6/8/2011

Motor Connection Diagrams
6 Leads

Across the Line Starting / Run - Delta:



Alternate Starting Connection - Wye:



Switch L1 and L2 to reverse rotation