

INDEX	MDSL0081-08
REV. LEVEL	1
SHEET	1 OF 1

TOSHIBA/HOUSTON

DRIP-PROOF
HORIZONTAL FOOT-MOUNTED
2300/4160V STOCK MOTORS

Fr. 587-5810
6-8 POLE
DIRECT COUPLE

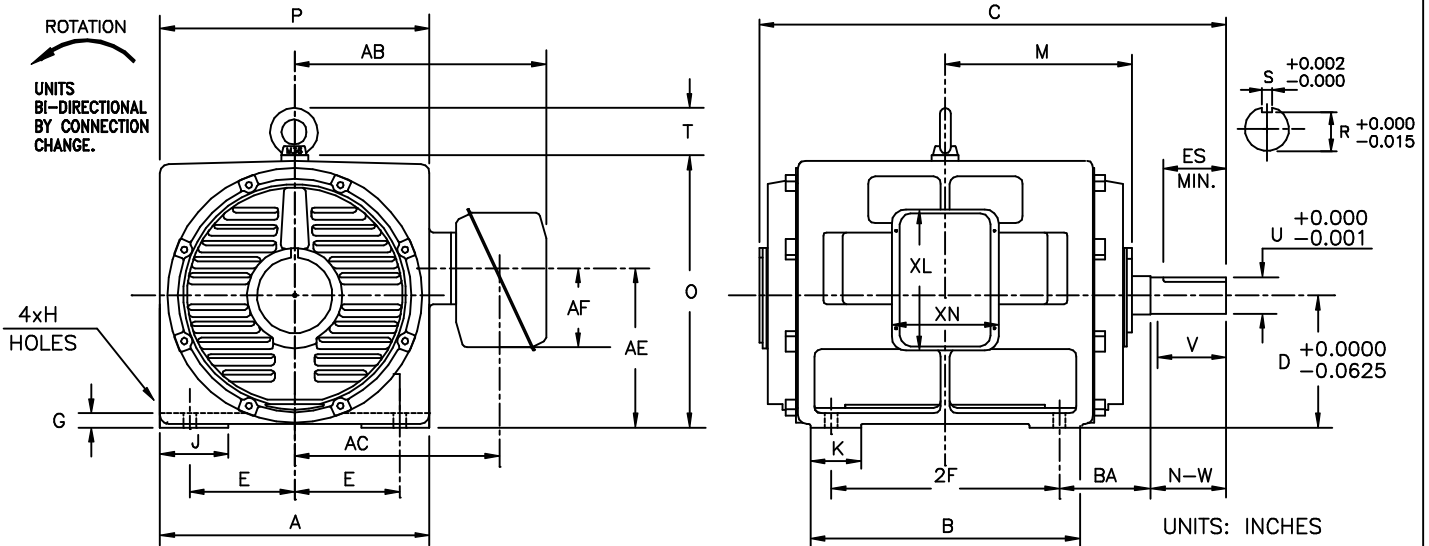

FRAME SIZE	MOUNTING				CONDUIT BOX						
	E	2F	H	BA	AA	AB	AC	AE	AF	XL	XN
587US	11.50	25.0	1.38	10.00	4.00	27.56	22.44	17.5	8.7	15.5	11.7
5810US	11.50	36.0	1.38	10.00	4.00	27.56	22.44	17.5	8.7	15.5	11.7

FRAME SIZE	MOTOR DIMENSIONS										
	A	B	C	D	G	J	K	M	O	P	T
587US	29.52	29.52	51.16	14.50	1.57	7.48	5.51	20.47	29.84	29.52	5.18
5810US	29.52	40.55	61.98	14.50	1.57	7.48	9.84	25.79	29.84	29.52	5.18

FRAME SIZE	SHAFT EXTENSION			KEY SEAT			BEARINGS		MAXIMUM WEIGHT
	N-W	V	U	R	S	ES	LS	OS	
587US	8.27	8.25	4.000	1.000	0.500	6.875	6322	6320	lbs.
5810US	8.27	8.25	4.000	1.000	0.500	6.875	6322	6320	lbs.

ALL DATA SUBJECT TO CHANGE WITHOUT NOTICE.
FOR CONSTRUCTION USE ONLY CERTIFIED DATA.

FOR REFERENCE PRELIMINARY CERTIFIED

NOTES:

1. DIMENSION V REPRESENTS LENGTH OF STRAIGHT PART OF SHAFT.
2. CONDUIT BOX MAY BE ROTATED IN 90° INCREMENTS AND MAY BE MOUNTED ON OPPOSITE SIDE ON SPECIAL ORDER.
3. KEY DIMENSIONS EQUAL S x S x 3.00 (MOTOR SUPPLIED WITH KEY)
4. MOTOR WEIGHT SHOWN IS MAXIMUM HORSEPOWER IN FRAME.

CUSTOMER: _____ P.O. NO.: _____ TAG NO.: _____

MOTOR MODEL NO.: _____ TOSHIBA FILE NO.: _____

HP: _____ RPM (SYN.): _____ VOLTAGE: _____ Hz: _____

FRAME SIZE: _____ LOG NO.: _____ LOG REV. LEVEL: _____

REMARKS: _____

PER: _____ ISSUE DATE: _____ SUPERSEDES: _____

TYPICAL MOTOR PERFORMANCE DATA

Model: F6006VLF3JM

HP	kW	Pole	FL RPM	Frame	Voltage	Hz	Phase	FL Amps
600	447	6	1185	5810US	2300/4160	60	3	138/79
Enclosure	IP	Ins. Class	S.F.	Duty	NEMA Nom. Eff.	NEMA Design	kVA Code	Ambient (°C)
ODP	12	F	1.15	CONT	95.0	-		40 C

Load	HP	kW	Amperes	Efficiency (%)	Power Factor (%)
Full Load	600.00	447.4	79	95.4	85.0
¾ Load	450.00	335.6	58	95.8	83.5
½ Load	300.00	223.7	42	95.9	76.5
¼ Load	150.00	111.9	30	92.6	55.6
No Load			22.0		2.9
Locked Rotor			401		190.5

Torque				Rotor wk ² Inertia (lb-ft ²)
Full Load (lb-ft)	Locked Rotor (% FLT)	Pull Up (% FLT)	Break Down (% FLT)	
2659	115	120	210	259.93

Safe Stall Time(s)		Sound Pressure dB(A) @ 1M	Bearings*		Approx. Motor Weight (lbs)
Cold	Hot		DE	NDE	
52	13	-	6322C3	6320C3 INS	4387

*Bearings are the only recommended spare part(s).

Motor Options:
Product Family:ODP
Mounting:Footed,Shaft:US Shaft

Customer	
Customer PO	
Sales Order	
Project #	

Tag:

All characteristics are average expected values.

TOSHIBA INTERNATIONAL CORPORATION · HOUSTON, TEXAS U.S.A.

Engineering	gminetos	Doc. Written By	D. Suarez	Doc.# / Rev	MPCF-1119 / 0
Engr. Date	8/7/2013	Doc. Approved By	M. Campbell	Doc. Issued	6/8/2011

SPEED TORQUE/CURRENT CURVE

Model: F6006VLF3JM

HP	kW	Pole	FL RPM	Frame	Voltage	Hz	Phase	FL Amps
600	447	6	1185	5810US	2300/4160	60	3	138/79
Enclosure	IP	Ins. Class	S.F.	Duty	NEMA Nom. Eff.	NEMA Design	kVA Code	Ambient (°C)
ODP	12	F	1.15	CONT	95.0	-		40 C
Locked Rotor Amps	Rotor wk ² Inertia (lb-ft ²)	Torque						Break Down (%)
		Full Load (lb-ft)	Locked Rotor (%)	Pull Up (%)				
401	259.93	2659	115	120			210	

Design Values

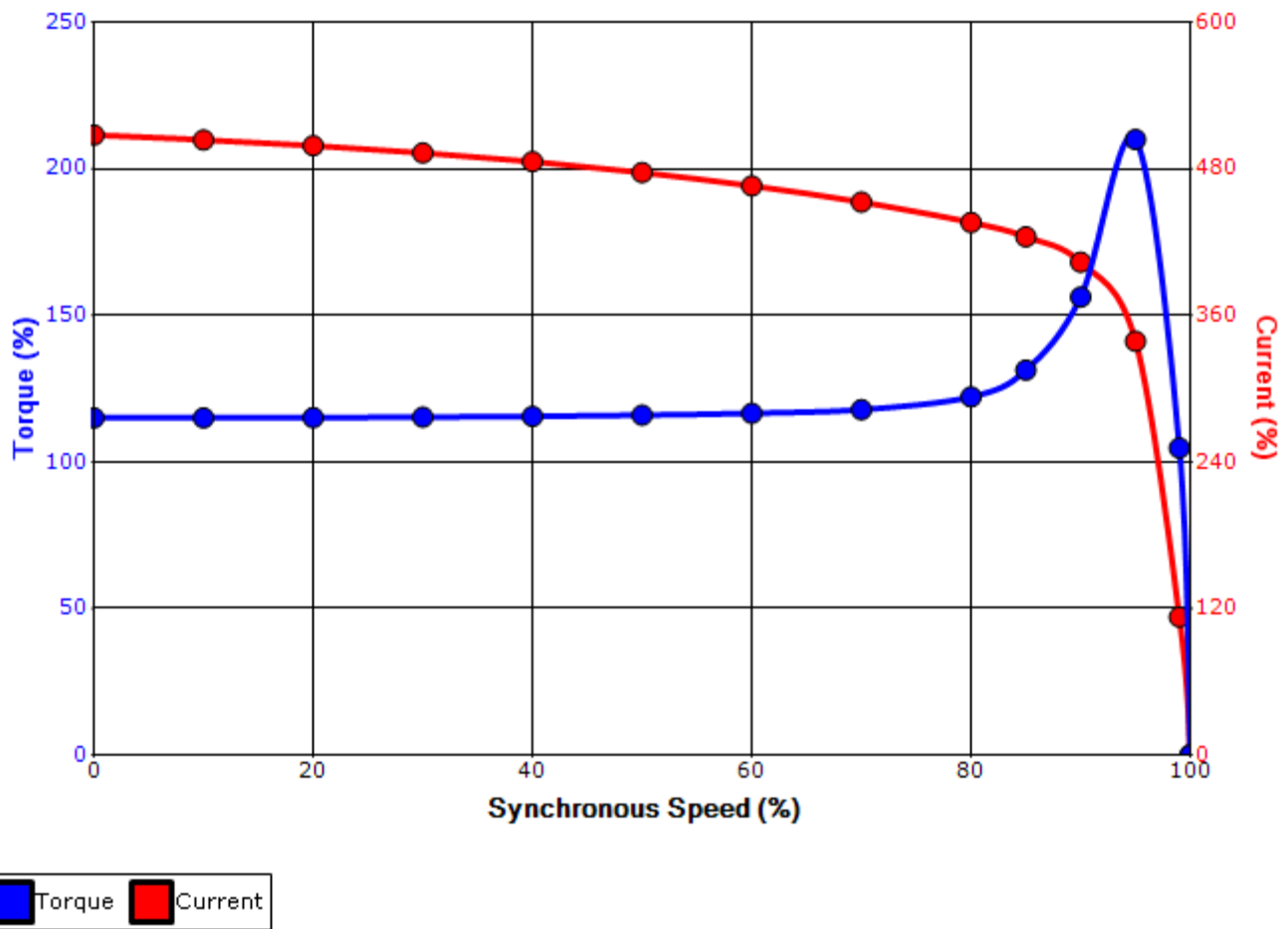

Customer		wk ² Load Inertia (lb-ft ²)	-
Customer PO		Load Type	-
Sales Order		Voltage (%)	100
Project #		Accel. Time	-

Tag:

All characteristics are average expected values.

TOSHIBA INTERNATIONAL CORPORATION · HOUSTON, TEXAS U.S.A.

Engineering	gminetos	Doc. Written By	D. Suarez	Doc.# / Rev	MPCF-1121 / 0
Engr. Date	8/7/2013	Doc. Approved By	M. Campbell	Doc. Issued	6/8/2011

Motor Connection Diagrams
6 Leads

Across-the-Line Starting / Running Connections

Low Voltage – Delta



High Voltage – Wye

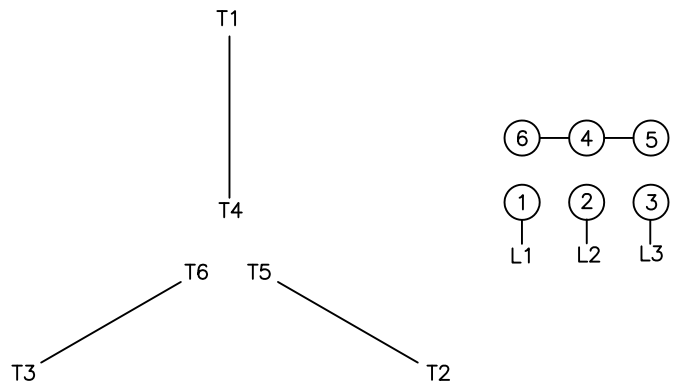

Switch L1 and L2 to reverse rotation