

4XM10 DEPTH
20
EQS-BC $\phi 165$

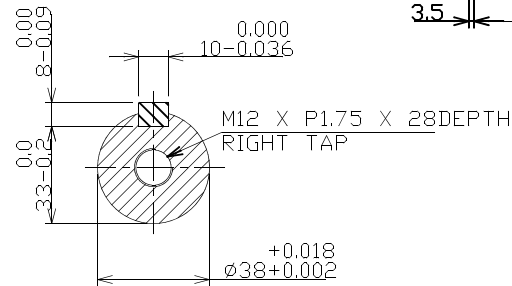
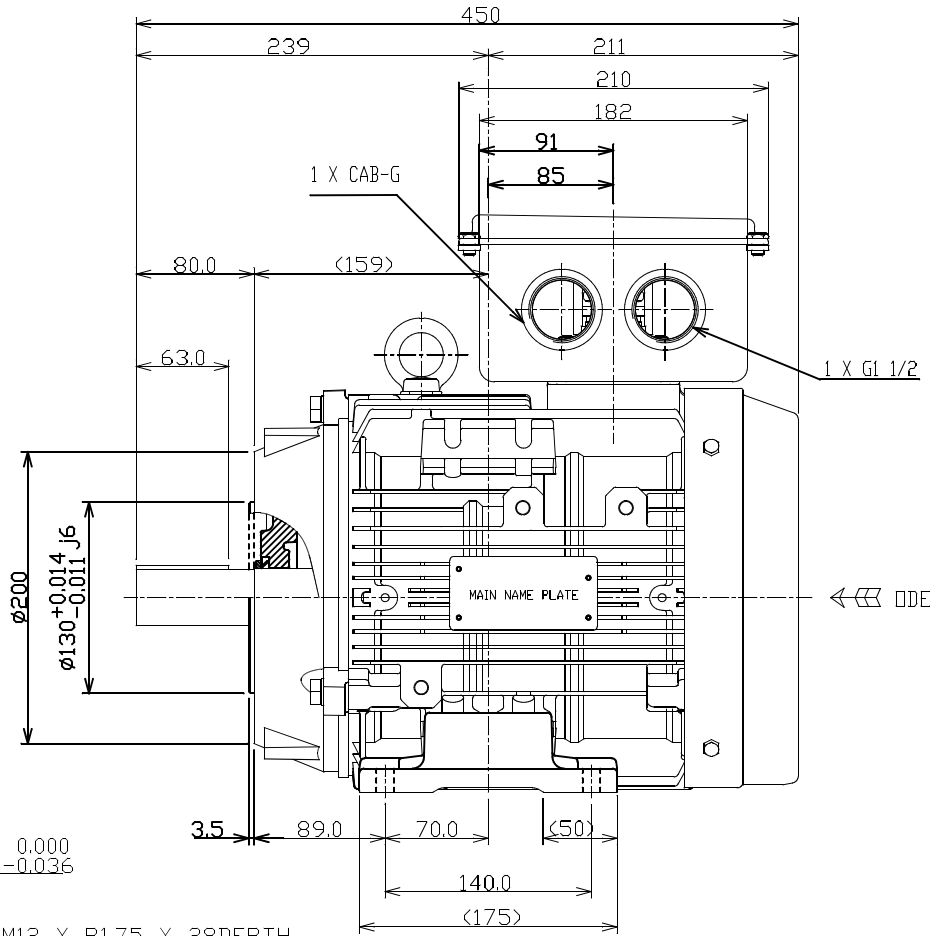
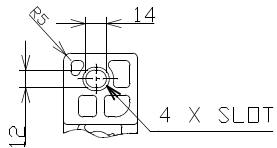

ROTATION: CCW
VIEW FROM: ODE

UNIT: mm

TOSHIBA RESERVES THE RIGHT TO MAKE CHANGES OF TECHNICAL IMPROVEMENT WITHOUT NOTICE. DO NOT USE FOR CONSTRUCTION, INSTALLATION, OR APPLICATION PURPOSES UNLESS THE DRAWING IS CERTIFIED.

B34-FLANGE MOTOR
OL DRAWING IEC GLOBAL

TYPE: 2-4-6P
400V
FRAME: 132S

TOLERANCES
X. ± 2.0
X.X ± 0.5
X.XX ± 0.1

3HFN000288

MAXIMUM
MOTOR WEIGHT
- lbs.
- kgs.

EQP Global SD
XT SERIES

DRAWN BY: HIEN, NGUYEN
CHECK BY: B.X.QUYNH
APPROVED BY: JAY BUGBEE

www.toshiba.com/ind

TOSHIBA
TOSHIBA INTERNATIONAL CORPORATION

NO	REVISION	DRAWN BY	DATE	CHECK

TOSHIBA INTERNATIONAL CORPORATION
Industrial Division / Houston Motor Plant

SQUIRREL CAGE INDUCTION MOTOR
PERFORMANCE SPECIFICATIONS

INDEX	MPCF-1033
SHEET NO.	1 of 1
ISSUED	7/31/13
SUPERSEDES	11/8/96
REVISION	2
WRITTEN BY	MDC
APPROVED BY	PAA

CUSTOMER: -
TIC SR No.: -

MOTOR NAMEPLATE DATA

H.P.: -	VOLTS: 230/400	3 PH / 50 Hz	S. RPM: 3000
FRAME: 132S	ENCL: TEFC	FLAMPS: 18.3/10.5	FLRPM: 2915
FORM: FCKL1	S.F.: -	IEC DESIGN N	INSUL CLASS: F
TYPE: IKKH	AMB.: 40°C	CODE: -	DUTY: Cont.
MODEL No.: Y552SDMV7HS-PL		kW: 5.5	
NOM. EFF.: 89.2	MIN. EFF.: -	cosØ 0.85	

AMPERAGE

LOCKED ROTOR: 135/78

TORQUES

FULL LOAD (lb-ft.): 13.3
 LOCKED ROTOR (%): 290
 BREAK DOWN (%): 395

****BEARINGS:**

DRIVE END: REFER TO NP
 OPPOSITE DRIVE END: REFER TO NP

EFFICIENCY

FULL LOAD: 89.0
 3/4 LOAD: 88.7
 1/2 LOAD: 86.7

POWER FACTOR

FULL LOAD: 85.1
 3/4 LOAD: 79.9
 1/2 LOAD: 69.2

ALL CHARACTERISTICS ARE AVERAGE EXPECTED VALUES BASED UPON RATED VOLTAGE,
 FREQUENCY AND SINEWAVE POWER INPUT.

THE DECLARED LOCKED ROTOR CURRENT HAS A TOLERANCE OF 20%.

* TEMPERATURE RISE WILL BE CONSISTENT WITH INSULATION, AMBIENT AND SERVICE FACTOR AS
 DEFINED BY NEMA-MG-12 OR -20.

** BEARINGS ARE THE ONLY RECOMMENDED SPARE PART(S).

CERTIFIED BY: Zichao Xie

DATE: 8/14/2020

TOSHIBA INTERNATIONAL CORPORATION

Speed Torque/Current Curve

Model #:	Y552SDMV7HS-PL			FLAmps:	18.3/10.5
Enclosure:	TEFC	Voltage:	230/400 V	Frame:	132S
Pole:	2	Frequency:	3 PH / 50 Hz	Ins. Class:	F
KW:	5.5	Rotor Inertia:	0.49 lb-ft ²	Date:	8/14/2020
FLRPM:	2915	Load Inertia:	N/A	File:	2Y55 Rev.1 (5.5)

Locked Rotor Amps:	135/78 A	Load Type:	N/A
Locked Rotor Torque:	290%	Starting at:	N/A
Breakdown Torque:	395%	Accel. Time:	N/A
Rated Torque:	13.3 lb-ft		

Design Values

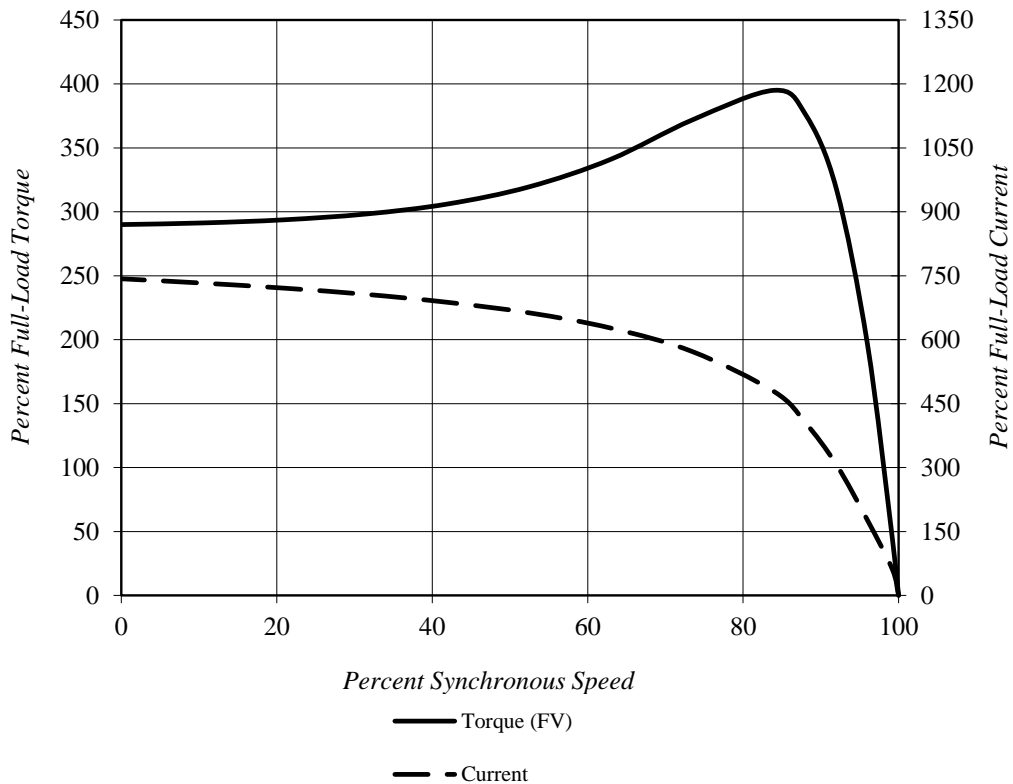

Comments: PROJECT -

D.E.Curve #: 2Y55 Rev.1 (5.5)

Prepared by: Zichao Xie

Checked by:

TOSHIBA INTERNATIONAL CORPORATION

Thermal Limit & Acceleration Curves

Design Values (For Reference Only)

Model #:	Y552SDMV7HS-PL			FLAmps:	18.3/10.5
Enclosure:	TEFC	Voltage:	230/400 V	Frame:	132S
Pole:	2	Frequency:	3 PH / 50 Hz	Ins. Class:	F
KW:	5.5	Rotor Inertia:	0.49 lb-ft ²	Date:	8/14/2020
FLRPM:	2915	Load Inertia:	N/A	File:	2Y55 Rev.1 (5.5)

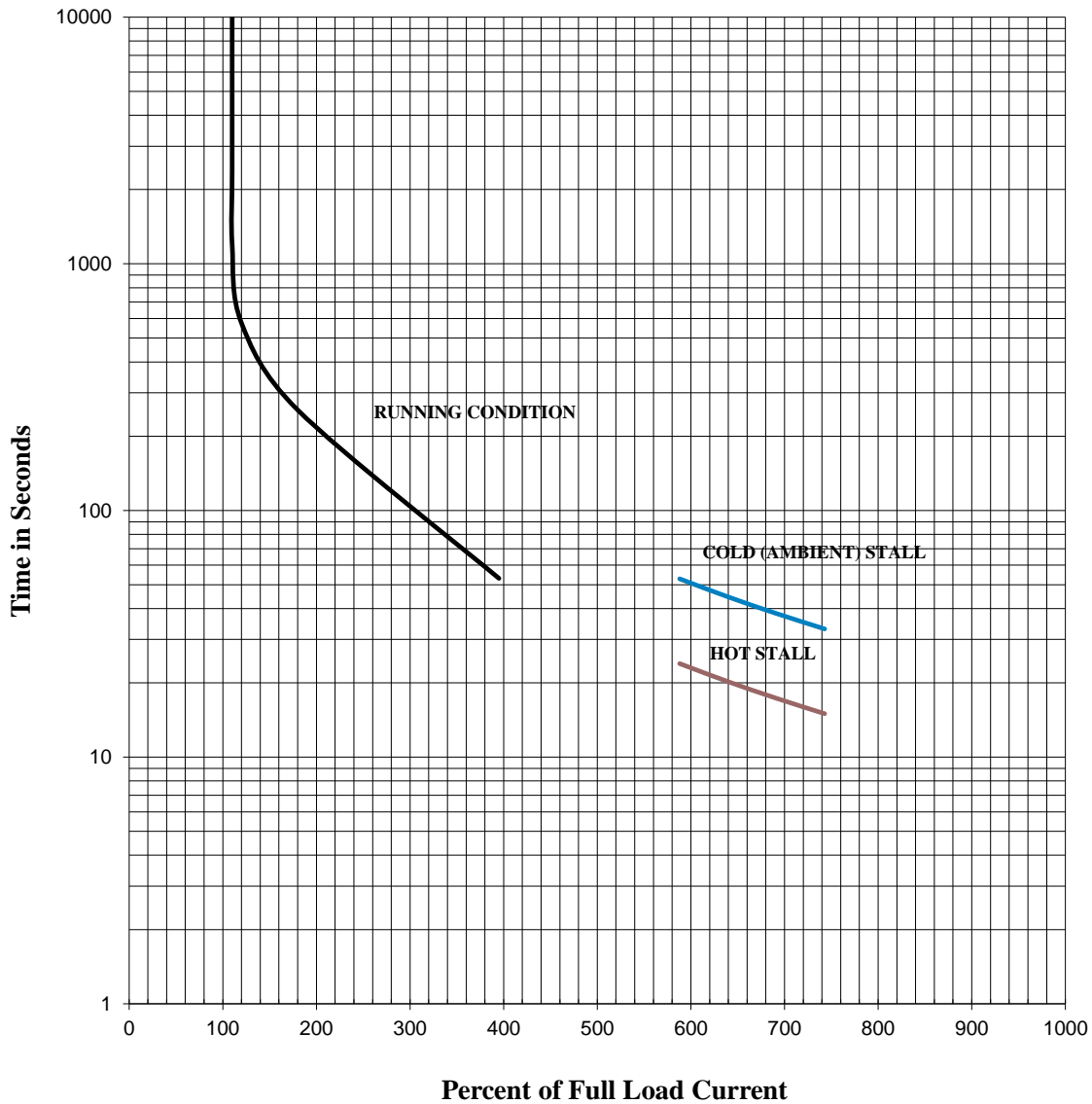

Comments: PROJECT -

D.E.Curve #: 2Y55 Rev.1 (5.5)

Prepared by: Zichao Xie

Checked by:

TOSHIBA INTERNATIONAL CORPORATION Industrial Division / Houston Motor Plant SQUIRREL CAGE INDUCTION MOTOR PERFORMANCE SPECIFICATIONS	INDEX	MPCF-1033
	SHEET NO.	1 of 1
	ISSUED	7/31/13
	SUPERSEDES	11/8/96
	REVISION	2
	WRITTEN BY	MDC
	APPROVED BY	PAA

CUSTOMER: -
TIC SR No.: -

MOTOR NAMEPLATE DATA			
H.P.: -	VOLTS: 240/415	3 PH / 50 Hz	S. RPM: 3000
FRAME: 132S	ENCL: TEFC	FLAMPS: 18.2/10.5	FLRPM: 2920
FORM: FCKL1	S.F.: -	IEC DESIGN N	INSUL CLASS: F
TYPE: IKKH	AMB.: 40°C	CODE: -	DUTY: Cont.
MODEL No.: Y552SDMV7HS-PL		kW: 5.5	
NOM. EFF.: 89.2	MIN. EFF.: -	cosØ 0.82	

AMPERAGE	TORQUES	**BEARINGS:
LOCKED ROTOR: 140/81	FULL LOAD (lb-ft.): 13.3	DRIVE END: REFER TO NP
	LOCKED ROTOR (%): 315	OPPOSITE DRIVE END: REFER TO NP
	BREAK DOWN (%): 410	

EFFICIENCY	POWER FACTOR
FULL LOAD: 89.2	FULL LOAD: 82.0
3/4 LOAD: 88.7	3/4 LOAD: 75.7
1/2 LOAD: 86.3	1/2 LOAD: 63.7

ALL CHARACTERISTICS ARE AVERAGE EXPECTED VALUES BASED UPON RATED VOLTAGE, FREQUENCY AND SINEWAVE POWER INPUT.
THE DECLARED LOCKED ROTOR CURRENT HAS A TOLERANCE OF 20%.
* TEMPERATURE RISE WILL BE CONSISTENT WITH INSULATION, AMBIENT AND SERVICE FACTOR AS DEFINED BY NEMA-MG-12 OR -20.
** BEARINGS ARE THE ONLY RECOMMENDED SPARE PART(S).

CERTIFIED BY: Zichao Xie
DATE: 8/14/2020

TOSHIBA INTERNATIONAL CORPORATION

Speed Torque/Current Curve

Model #:	Y552SDMV7HS-PL			FLAmps:	18.2/10.5
Enclosure:	TEFC	Voltage:	240/415 V	Frame:	132S
Pole:	2	Frequency:	3 PH / 50 Hz	Ins. Class:	F
KW:	5.5	Rotor Inertia:	0.49 lb-ft ²	Date:	8/14/2020
FLRPM:	2920	Load Inertia:	N/A	File:	2Y55 Rev.1 (5.5)

Locked Rotor Amps:	140/81 A	Load Type:	N/A
Locked Rotor Torque:	315%	Starting at:	N/A
Breakdown Torque:	410%	Accel. Time:	N/A
Rated Torque:	13.3 lb-ft		

Design Values

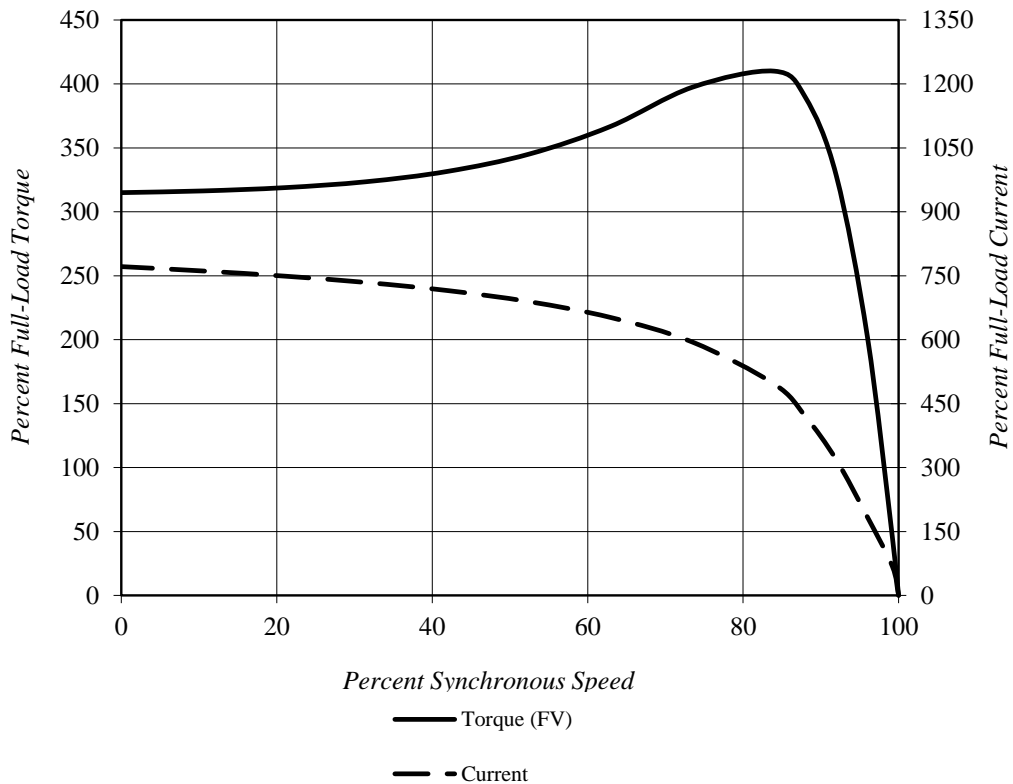

Comments: PROJECT -

D.E.Curve #: 2Y55 Rev.1 (5.5)

Prepared by: Zichao Xie

Checked by:

TOSHIBA INTERNATIONAL CORPORATION

Thermal Limit & Acceleration Curves

Design Values (For Reference Only)

Model #:	Y552SDMV7HS-PL			FLAmps:	18.2/10.5
Enclosure:	TEFC	Voltage:	240/415 V	Frame:	132S
Pole:	2	Frequency:	3 PH / 50 Hz	Ins. Class:	F
KW:	5.5	Rotor Inertia:	0.49 lb-ft ²	Date:	8/14/2020
FLRPM:	2920	Load Inertia:	N/A	File:	2Y55 Rev.1 (5.5)

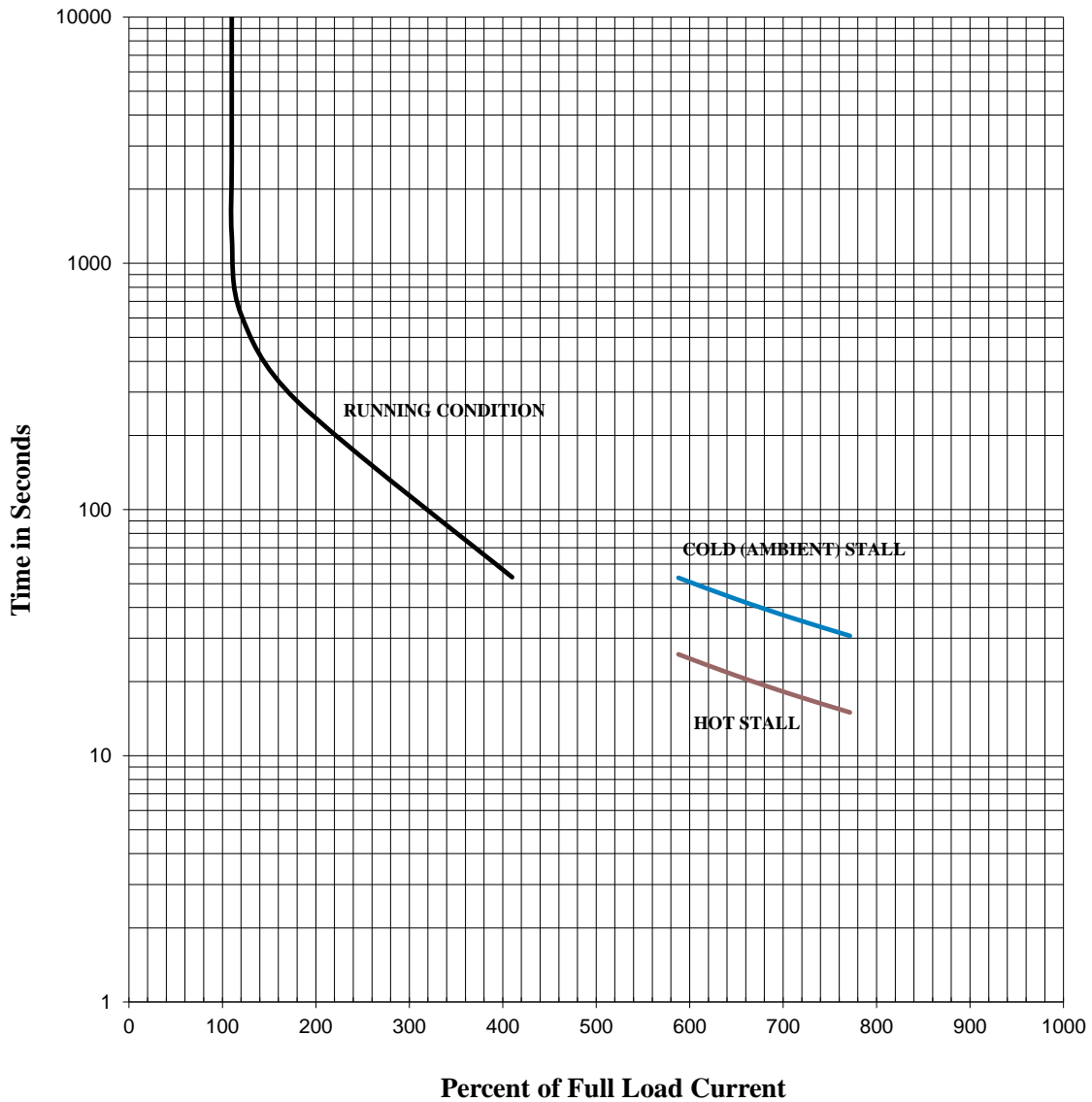

Comments: PROJECT -

D.E.Curve #: 2Y55 Rev.1 (5.5)

Prepared by: Zichao Xie

Checked by:

TOSHIBA INTERNATIONAL CORPORATION
Industrial Division / Houston Motor Plant

SQUIRREL CAGE INDUCTION MOTOR
PERFORMANCE SPECIFICATIONS

INDEX	MPCF-1033
SHEET NO.	1 of 1
ISSUED	7/31/13
SUPERSEDES	11/8/96
REVISION	2
WRITTEN BY	MDC
APPROVED BY	PAA

CUSTOMER: -
TIC SR No.: -

MOTOR NAMEPLATE DATA

H.P.: -	VOLTS: 220/380	3 PH / 50 Hz	S. RPM: 3000
FRAME: 132S	ENCL: TEFC	FLAMPS: 18.7/10.8	FLRPM: 2905
FORM: FCKL1	S.F.: -	IEC DESIGN N	INSUL CLASS: F
TYPE: IKKH	AMB.: 40°C	CODE: -	DUTY: Cont.
MODEL No.: Y552SDMV7HS-PL		kW: 5.5	
NOM. EFF.: 89.2	MIN. EFF.: -	cosØ 0.88	

AMPERAGE

LOCKED ROTOR: 126/73

TORQUES

FULL LOAD (lb-ft.): 13.4
LOCKED ROTOR (%): 255
BREAK DOWN (%): 355

****BEARINGS:**

DRIVE END: REFER TO NP
OPPOSITE DRIVE END: REFER TO NP

EFFICIENCY

FULL LOAD: 88.3
3/4 LOAD: 88.3
1/2 LOAD: 86.7

POWER FACTOR

FULL LOAD: 88.0
3/4 LOAD: 84.4
1/2 LOAD: 75.8

ALL CHARACTERISTICS ARE AVERAGE EXPECTED VALUES BASED UPON RATED VOLTAGE,
FREQUENCY AND SINEWAVE POWER INPUT.

THE DECLARED LOCKED ROTOR CURRENT HAS A TOLERANCE OF 20%.

* TEMPERATURE RISE WILL BE CONSISTENT WITH INSULATION, AMBIENT AND SERVICE FACTOR AS
DEFINED BY NEMA-MG-12 OR -20.

** BEARINGS ARE THE ONLY RECOMMENDED SPARE PART(S).

CERTIFIED BY: Zichao Xie

DATE: 8/14/2020

TOSHIBA INTERNATIONAL CORPORATION

Speed Torque/Current Curve

Model #:	Y552SDMV7HS-PL			FLAmps:	18.7/10.8
Enclosure:	TEFC	Voltage:	220/380 V	Frame:	132S
Pole:	2	Frequency:	3 PH / 50 Hz	Ins. Class:	F
KW:	5.5	Rotor Inertia:	0.49 lb-ft ²	Date:	8/14/2020
FLRPM:	2905	Load Inertia:	N/A	File:	2Y55 Rev.1 (5.5)

Locked Rotor Amps:	126/73 A	Load Type:	N/A
Locked Rotor Torque:	255%	Starting at:	N/A
Breakdown Torque:	355%	Accel. Time:	N/A
Rated Torque:	13.4 lb-ft		

Design Values

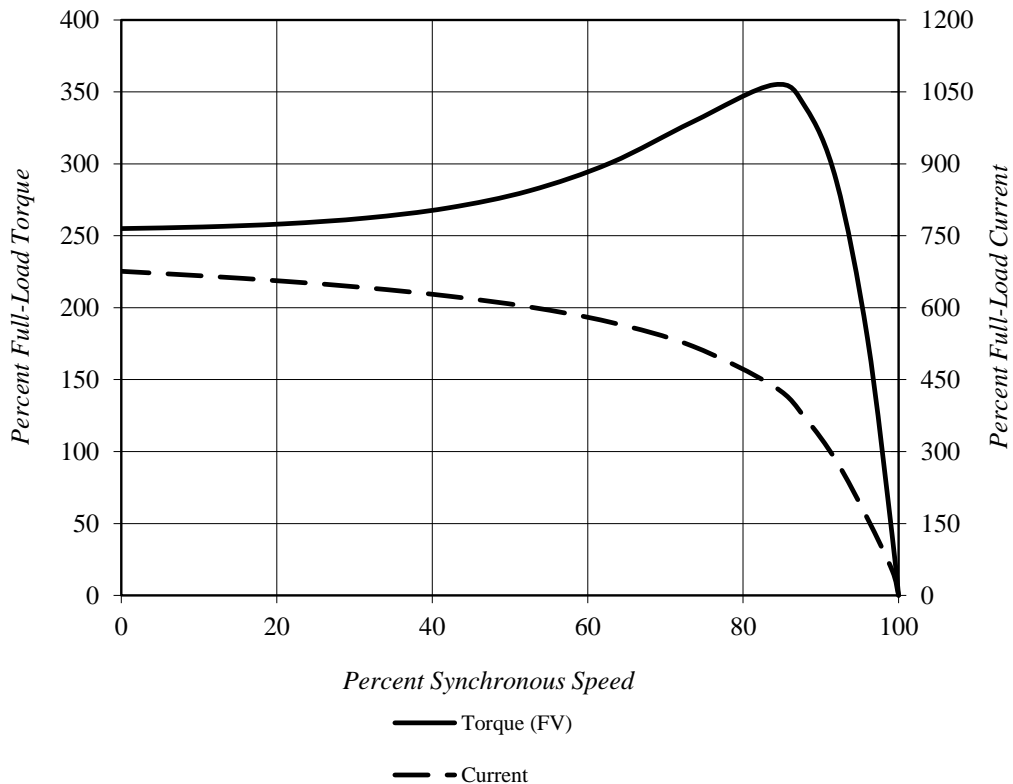

Comments: PROJECT -

D.E.Curve #: 2Y55 Rev.1 (5.5)

Prepared by: Zichao Xie

Checked by:

TOSHIBA INTERNATIONAL CORPORATION

Thermal Limit & Acceleration Curves

Design Values (For Reference Only)

Model #:	Y552SDMV7HS-PL			FLAmps:	18.7/10.8
Enclosure:	TEFC	Voltage:	220/380 V	Frame:	132S
Pole:	2	Frequency:	3 PH / 50 Hz	Ins. Class:	F
KW:	5.5	Rotor Inertia:	0.49 lb-ft ²	Date:	8/14/2020
FLRPM:	2905	Load Inertia:	N/A	File:	2Y55 Rev.1 (5.5)

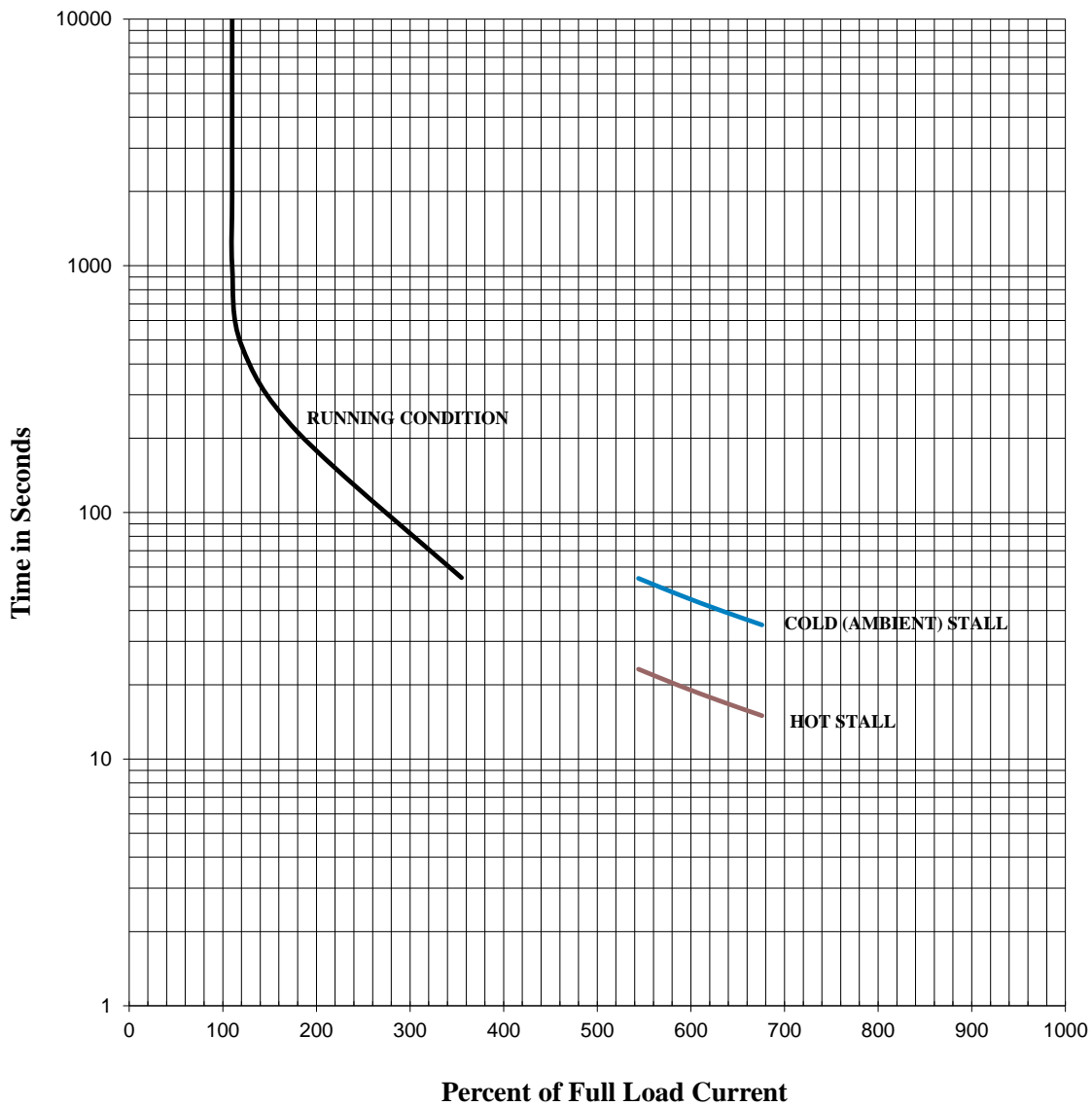

Comments: PROJECT _____

D.E.Curve #: 2Y55 Rev.1 (5.5)

Prepared by: Zichao Xie

Checked by: _____

TOSHIBA INTERNATIONAL CORPORATION Industrial Division / Houston Motor Plant SQUIRREL CAGE INDUCTION MOTOR PERFORMANCE SPECIFICATIONS	INDEX	MPCF-1033
	SHEET NO.	1 of 1
	ISSUED	7/31/13
	SUPERSEDES	11/8/96
	REVISION	2
	WRITTEN BY	MDC
	APPROVED BY	PAA

CUSTOMER: -
TIC SR No.: -

MOTOR NAMEPLATE DATA			
H.P.: 7.5	VOLTS: 460	3 PH / 60 Hz	S. RPM: 3600
FRAME: 132S	ENCL: TEFC	FLAMPS: 9.0	FLRPM: 3530
FORM: FCKL1	S.F.: 1.15	NEMA DESIGN: A	INSUL CLASS: F
TYPE: IKKH	AMB.: 40°C	CODE: K	DUTY: Cont.
MODEL No.: Y552SDMV7HS-PL		kW: 5.5	
NOM. EFF.: 89.5	MIN. EFF.: -	P.F.: 85.0	

AMPERAGE	TORQUES	**BEARINGS:
LOCKED ROTOR: 78	FULL LOAD (lb-ft.): 11.0	DRIVE END: REFER TO NP
	LOCKED ROTOR (%): 345	OPPOSITE DRIVE END: REFER TO NP
	BREAK DOWN (%): 420	

EFFICIENCY	POWER FACTOR
FULL LOAD: 90.2	FULL LOAD: 85.2
3/4 LOAD: 89.4	3/4 LOAD: 80.1
1/2 LOAD: 86.8	1/2 LOAD: 69.3

ALL CHARACTERISTICS ARE AVERAGE EXPECTED VALUES BASED UPON RATED VOLTAGE, FREQUENCY AND SINEWAVE POWER INPUT.
 THE DECLARED LOCKED ROTOR CURRENT HAS A TOLERANCE OF 20%.
 * TEMPERATURE RISE WILL BE CONSISTENT WITH INSULATION, AMBIENT AND SERVICE FACTOR AS DEFINED BY NEMA-MG-12 OR -20.
 ** BEARINGS ARE THE ONLY RECOMMENDED SPARE PART(S).

CERTIFIED BY: Zichao Xie

DATE: 8/14/2020

TOSHIBA INTERNATIONAL CORPORATION

Speed Torque/Current Curve

Model #:	Y552SDMV7HS-PL			FLAmps:	9.0
Enclosure:	TEFC	Voltage:	460 V	Frame:	132S
Pole:	2	Frequency:	3 PH / 60 Hz	Ins. Class:	F
HP:	7.5	Rotor Inertia:	0.49 lb-ft ²	Date:	8/14/2020
FLRPM:	3530	Load Inertia:	N/A	File:	2Y55 Rev.1 (5.5)

Locked Rotor Amps:	78 A	Load Type:	N/A
Locked Rotor Torque:	345%	Starting at:	N/A
Breakdown Torque:	420%	Accel. Time:	N/A
Rated Torque:	11 lb-ft		

Design Values

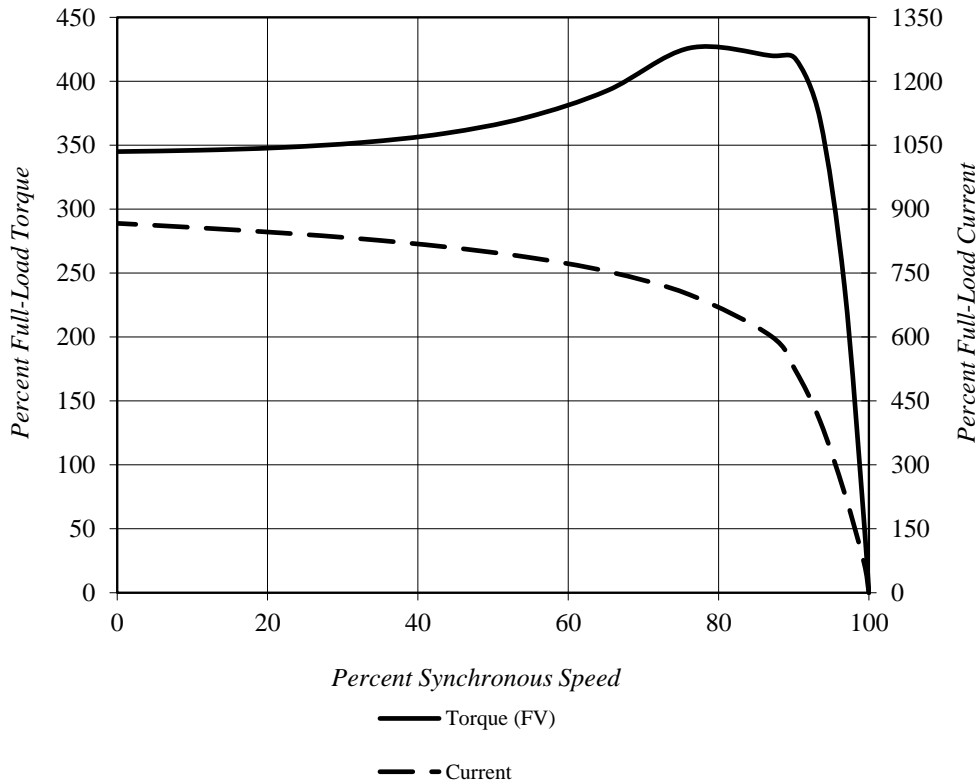

Comments: PROJECT -

D.E. Curve #: 2Y55 Rev.1 (5.5)

Prepared by: Zichao Xie

Checked by:

TOSHIBA INTERNATIONAL CORPORATION

Thermal Limit & Acceleration Curves

Design Values (For Reference Only)

Model #:	Y552SDMV7HS-PL			FLAmps:	9.0
Enclosure:	TEFC	Voltage:	460 V	Frame:	132S
Pole:	2	Frequency:	3 PH / 60 Hz	Ins. Class:	F
HP:	7.5	Rotor Inertia:	0.49 lb-ft ²	Date:	8/14/2020
FLRPM:	3530	Load Inertia:	N/A	File:	2Y55 Rev.1 (5.5)

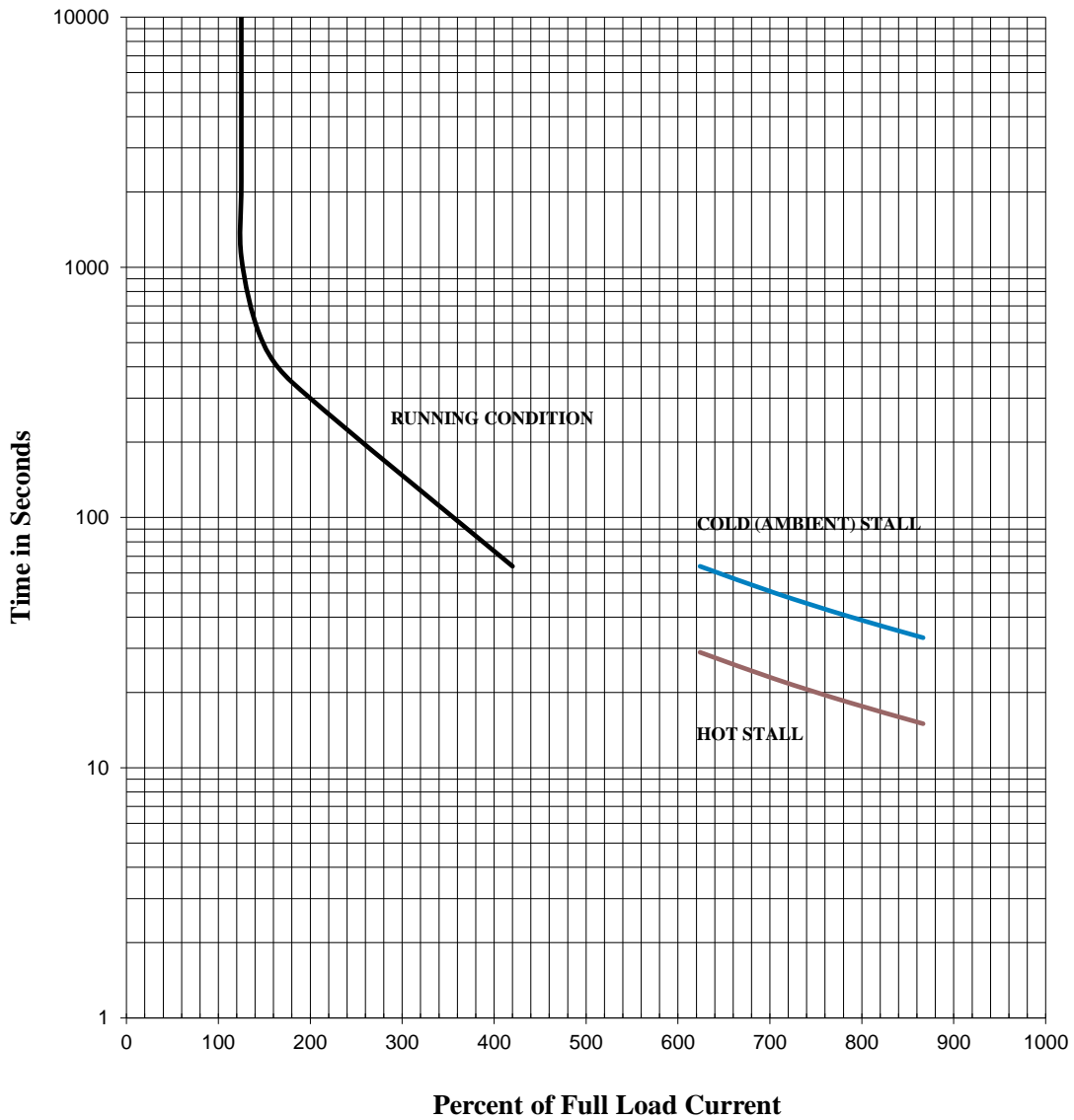

Comments: PROJECT -

D.E. Curve #: 2Y55 Rev.1 (5.5)

Prepared by: Zichao Xie	Checked by:
--------------------------------	--------------------