

4XM10 DEPTH 20
EQS-BC Ø165

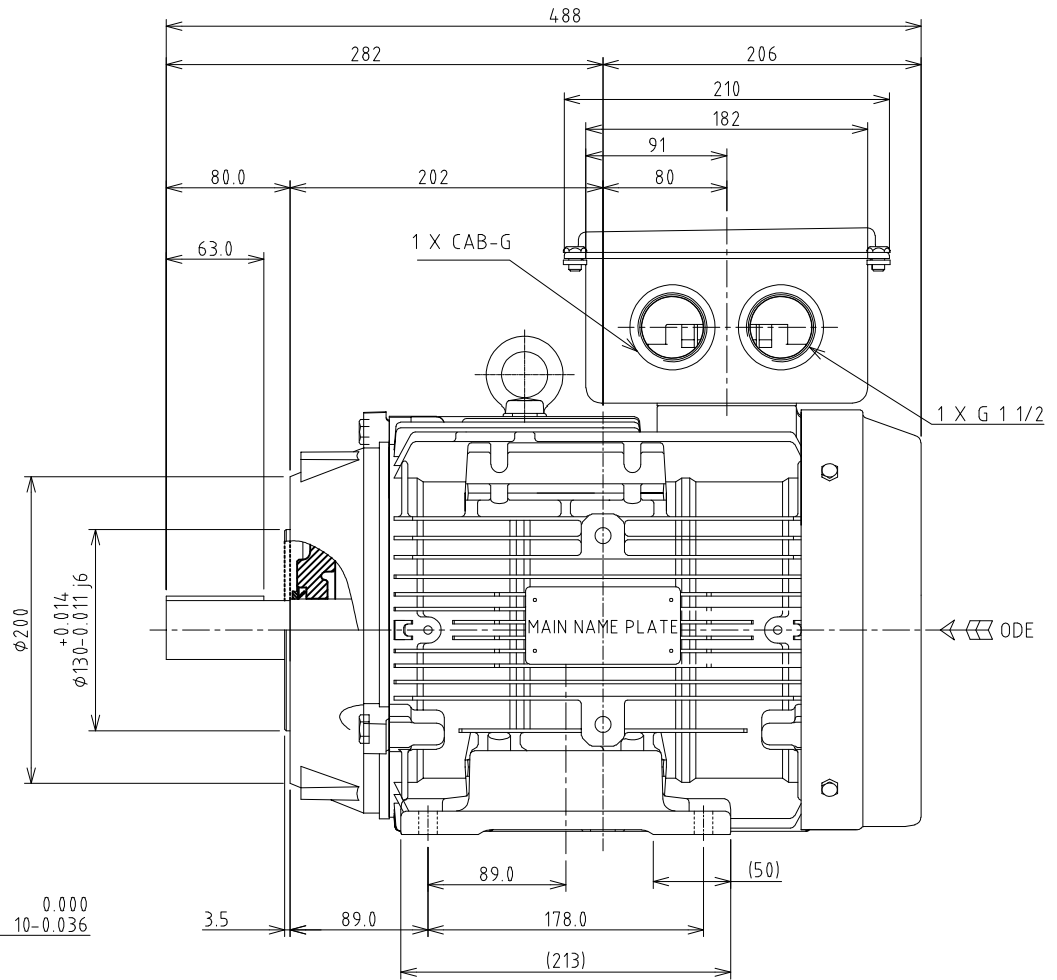
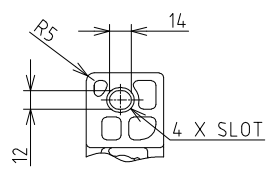

1 X CAB-G

1 X G 1 1/2

MAIN NAME PLATE

ODE

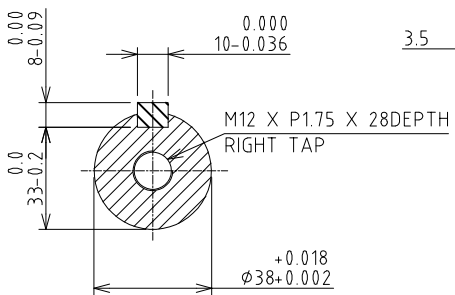

ROTATION: CCW
VIEW FROM: ODE

UNIT: mm

TOSHIBA RESERVES THE RIGHT TO MAKE CHANGES OF TECHNICAL IMPROVEMENT WITHOUT NOTICE. DO NOT USE FOR CONSTRUCTION, INSTALLATION, OR APPLICATION PURPOSES UNLESS THE DRAWING IS CERTIFIED.

B34-FLANGE MOTOR OL DRAWING IEC GLOBAL	TYPE: 2-4-6P - 400V
	FRAME: 132M
3HFN000289	
TOSHIBA	
TOSHIBA INTERNATIONAL CORPORATION	

TOLERANCES	
X.	±2.0
X.X	±0.5
X.XX	±0.1
MAXIMUM MOTOR WEIGHT	
- lbs.	
- kgs.	

EQP Global SD
XT SERIES

DRAWN BY: HIEN. NGUYEN
CHECK BY: B.X.QUYNH
APPROVED BY: JAY BUGBEE

www.toshiba.com/ind

NO	REVISION	DRAWN BY	DATE	CHECK
01	Change to the length KEY	T.Danh	Sep-12-18	B.Quynh

TOSHIBA INTERNATIONAL CORPORATION Industrial Division / Houston Motor Plant SQUIRREL CAGE INDUCTION MOTOR PERFORMANCE SPECIFICATIONS	INDEX	MPCF-1033
	SHEET NO.	1 of 1
	ISSUED	7/31/13
	SUPERSEDES	11/8/96
	REVISION	2
	WRITTEN BY	MDC
	APPROVED BY	PAA

CUSTOMER: -
TIC SR No.: -

MOTOR NAMEPLATE DATA			
H.P.: -	VOLTS: 230/400	3 PH / 50 Hz	S. RPM: 1000
FRAME: 132M	ENCL: TEFC	FLAMPS: 20/11.6	FLRPM: 970
FORM: FBKL1	S.F.: -	IEC DESIGN N	INSUL CLASS: F
TYPE: IKH	AMB.: 40°C	CODE: -	DUTY: Cont.
MODEL No.: Y556SDMV7HS-PL		kW: 5.5	
NOM. EFF.: 88.0	MIN. EFF.: -	cosØ 0.76	

AMPERAGE	TORQUES	**BEARINGS:
LOCKED ROTOR: 152/88	FULL LOAD (lb-ft.): 40	DRIVE END: REFER TO NP
	LOCKED ROTOR (%): 285	OPPOSITE DRIVE END: REFER TO NP
	BREAK DOWN (%): 370	

EFFICIENCY	POWER FACTOR
FULL LOAD: 90.3	FULL LOAD: 76.1
3/4 LOAD: 90.5	3/4 LOAD: 71.1
1/2 LOAD: 89.1	1/2 LOAD: 60.7

ALL CHARACTERISTICS ARE AVERAGE EXPECTED VALUES BASED UPON RATED VOLTAGE, FREQUENCY AND SINEWAVE POWER INPUT.
THE DECLARED LOCKED ROTOR CURRENT HAS A TOLERANCE OF 20%.
* TEMPERATURE RISE WILL BE CONSISTENT WITH INSULATION, AMBIENT AND SERVICE FACTOR AS DEFINED BY NEMA-MG-12 OR -20.
** BEARINGS ARE THE ONLY RECOMMENDED SPARE PART(S).

CERTIFIED BY: Zichao Xie
DATE: 7/31/2020

TOSHIBA INTERNATIONAL CORPORATION

Speed Torque/Current Curve

Model #:	Y556SDMV7HS-PL			FLAmps:	20/11.6
Enclosure:	TEFC	Voltage:	230/400 V	Frame:	132M
Pole:	6	Frequency:	3 PH / 50 Hz	Ins. Class:	F
KW:	5.5	Rotor Inertia:	2.0 lb-ft ²	Date:	7/31/2020
FLRPM:	970	Load Inertia:	N/A	File:	GH6Y55 (5.5kW)

Locked Rotor Amps:	152/88 A	Load Type:	N/A
Locked Rotor Torque:	285%	Starting at:	N/A
Breakdown Torque:	370%	Accel. Time:	N/A
Rated Torque:	40 lb-ft		

Design Values

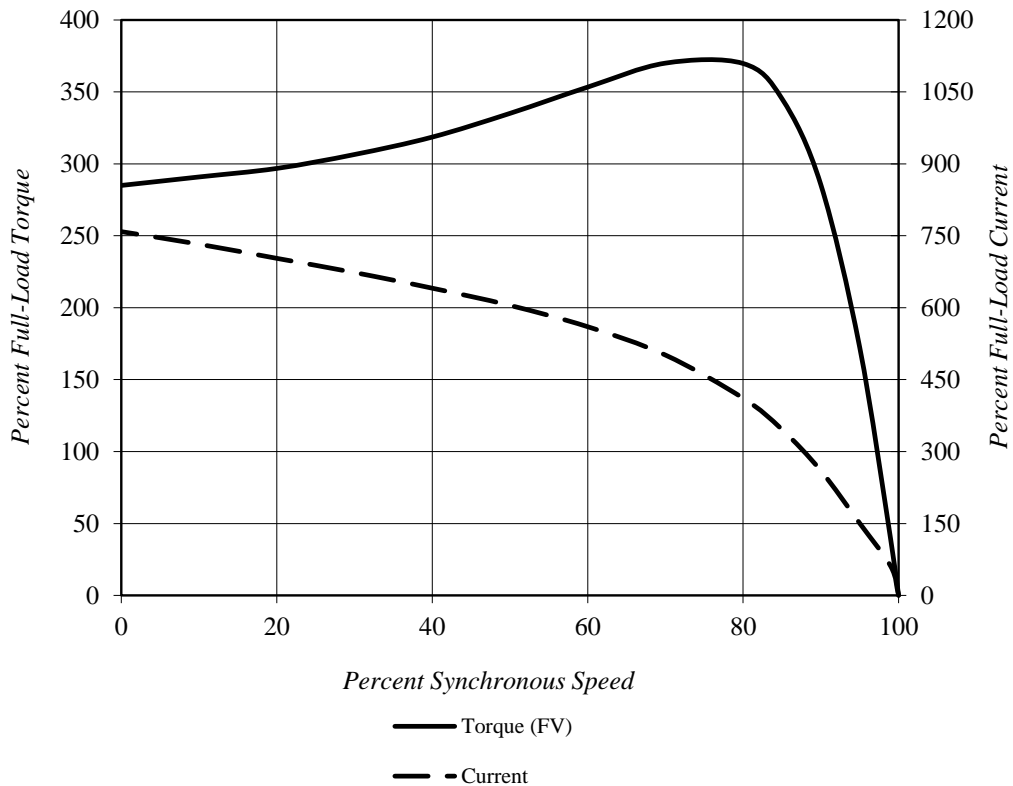

Comments: PROJECT -

D.E. Curve #: GH6Y55 (5.5kW)

Prepared by: Zichao Xie

Checked by:

TOSHIBA INTERNATIONAL CORPORATION

Thermal Limit & Acceleration Curves

Design Values (For Reference Only)

Model #:	Y556SDMV7HS-PL			FLAmps:	20/11.6
Enclosure:	TEFC	Voltage:	230/400 V	Frame:	132M
Pole:	6	Frequency:	3 PH / 50 Hz	Ins. Class:	F
KW:	5.5	Rotor Inertia:	2.0 lb-ft ²	Date:	7/31/2020
FLRPM:	970	Load Inertia:	N/A	File:	GH6Y55 (5.5kW)

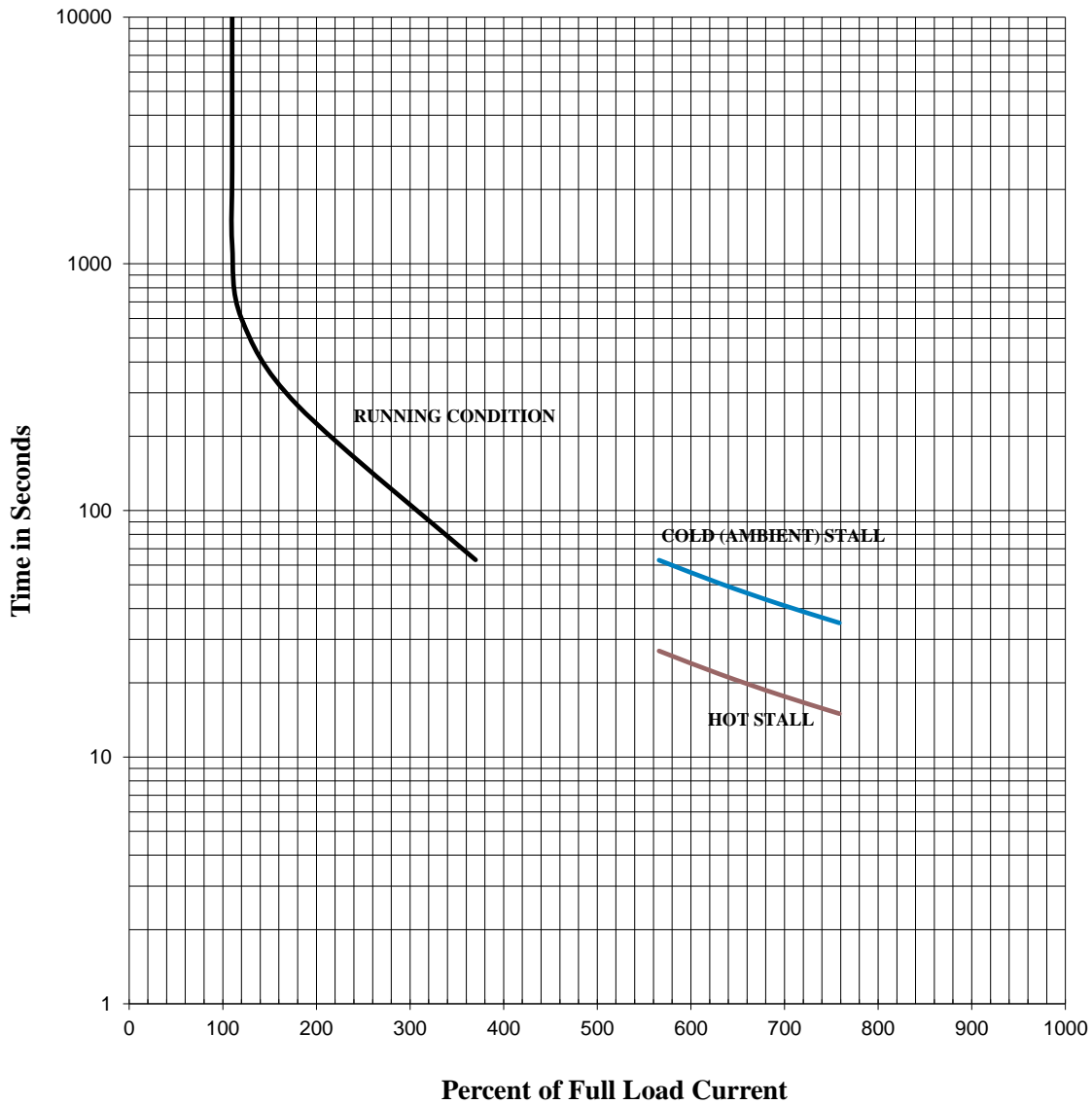

Comments: PROJECT -

D.E. Curve #: GH6Y55 (5.5kW)

Prepared by: Zichao Xie

Checked by:

TOSHIBA INTERNATIONAL CORPORATION
Industrial Division / Houston Motor Plant

SQUIRREL CAGE INDUCTION MOTOR
PERFORMANCE SPECIFICATIONS

INDEX	MPCF-1033
SHEET NO.	1 of 1
ISSUED	7/31/13
SUPERSEDES	11/8/96
REVISION	2
WRITTEN BY	MDC
APPROVED BY	PAA

CUSTOMER: -
TIC SR No.: -

MOTOR NAMEPLATE DATA

H.P.: -	VOLTS: 240/415	3 PH / 50 Hz	S. RPM: 1000
FRAME: 132M	ENCL: TEFC	FLAMPS: 19.2/11.1	FLRPM: 970
FORM: FBKL1	S.F.: -	IEC DESIGN N	INSUL CLASS: F
TYPE: IKKH	AMB.: 40°C	CODE: -	DUTY: Cont.
MODEL No.: Y556SDMV7HS-PL		kW: 5.5	
NOM. EFF.: 88.0	MIN. EFF.: -	cosØ 0.76	

AMPERAGE

LOCKED ROTOR: 159/92

TORQUES

FULL LOAD (lb-ft.): 40
LOCKED ROTOR (%): 310
BREAK DOWN (%): 390

****BEARINGS:**

DRIVE END: REFER TO NP
OPPOSITE DRIVE END: REFER TO NP

EFFICIENCY

FULL LOAD: 90.7
3/4 LOAD: 90.6
1/2 LOAD: 88.9

POWER FACTOR

FULL LOAD: 76.0
3/4 LOAD: 70.3
1/2 LOAD: 59.1

ALL CHARACTERISTICS ARE AVERAGE EXPECTED VALUES BASED UPON RATED VOLTAGE,
FREQUENCY AND SINEWAVE POWER INPUT.

THE DECLARED LOCKED ROTOR CURRENT HAS A TOLERANCE OF 20%.

* TEMPERATURE RISE WILL BE CONSISTENT WITH INSULATION, AMBIENT AND SERVICE FACTOR AS
DEFINED BY NEMA-MG-12 OR -20.

** BEARINGS ARE THE ONLY RECOMMENDED SPARE PART(S).

CERTIFIED BY: Zichao Xie

DATE: 7/31/2020

TOSHIBA INTERNATIONAL CORPORATION

Speed Torque/Current Curve

Model #:	Y556SDMV7HS-PL			FLAmps:	19.2/11.1
Enclosure:	TEFC	Voltage:	240/415 V	Frame:	132M
Pole:	6	Frequency:	3 PH / 50 Hz	Ins. Class:	F
KW:	5.5	Rotor Inertia:	2.0 lb-ft ²	Date:	7/31/2020
FLRPM:	970	Load Inertia:	N/A	File:	GH6Y55 (5.5kW)

Locked Rotor Amps:	159/92 A	Load Type:	N/A
Locked Rotor Torque:	310%	Starting at:	N/A
Breakdown Torque:	390%	Accel. Time:	N/A
Rated Torque:	40 lb-ft		

Design Values

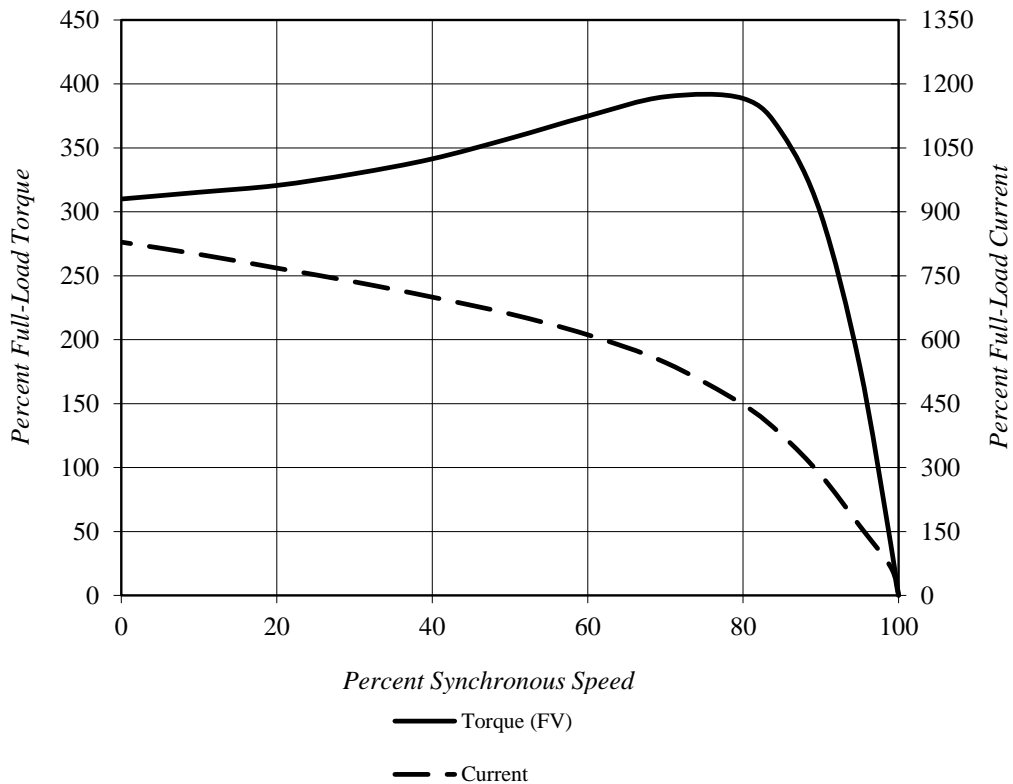

Comments: PROJECT -

D.E. Curve #: GH6Y55 (5.5kW)

Prepared by: Zichao Xie

Checked by:

TOSHIBA INTERNATIONAL CORPORATION

Thermal Limit & Acceleration Curves

Design Values (For Reference Only)

Model #:	Y556SDMV7HS-PL			FLAmps:	19.2/11.1
Enclosure:	TEFC	Voltage:	240/415 V	Frame:	132M
Pole:	6	Frequency:	3 PH / 50 Hz	Ins. Class:	F
KW:	5.5	Rotor Inertia:	2.0 lb-ft ²	Date:	7/31/2020
FLRPM:	970	Load Inertia:	N/A	File:	GH6Y55 (5.5kW)

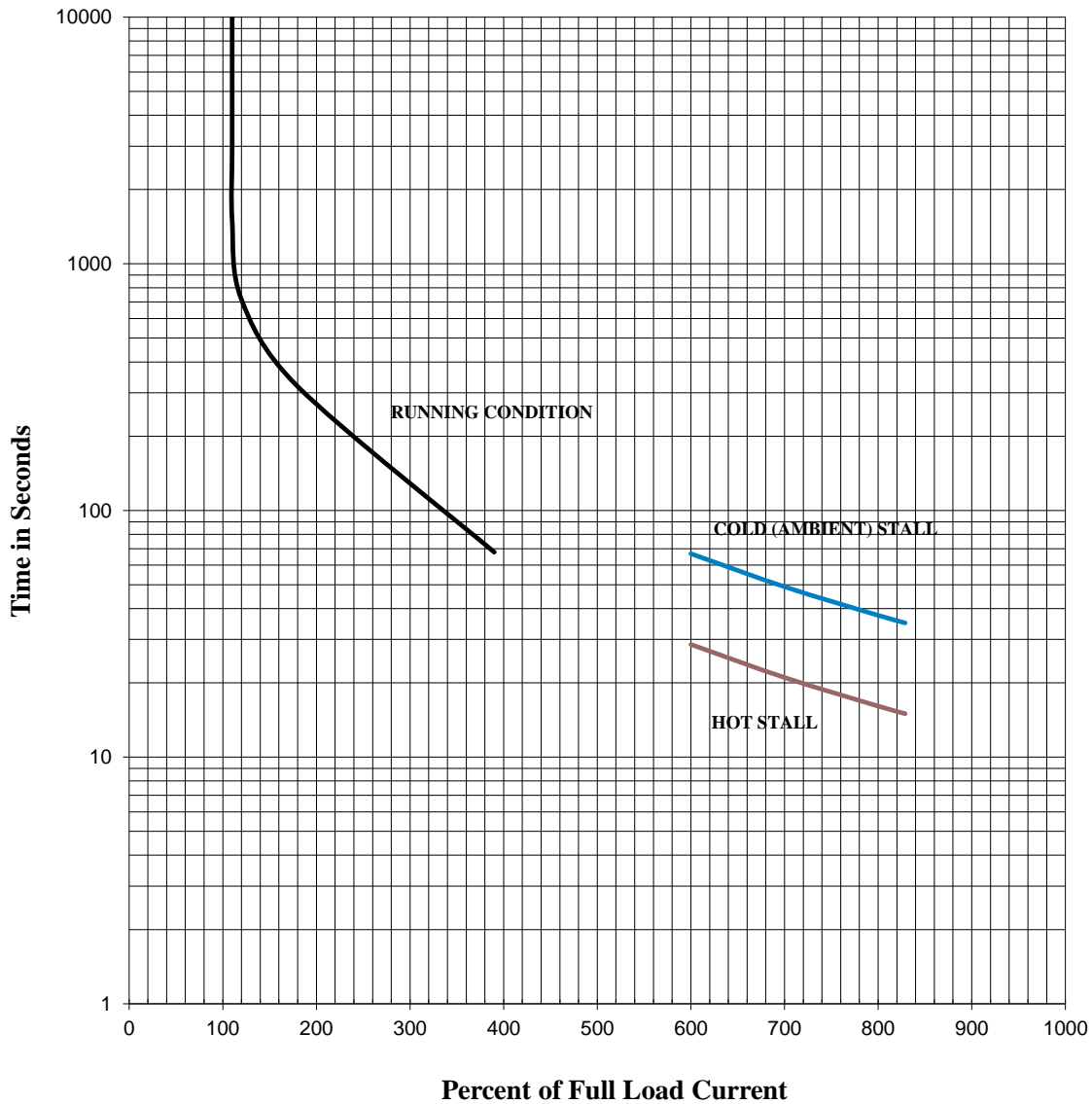

Comments: PROJECT -

D.E. Curve #: GH6Y55 (5.5kW)

Prepared by: Zichao Xie

Checked by:

TOSHIBA INTERNATIONAL CORPORATION
Industrial Division / Houston Motor Plant

SQUIRREL CAGE INDUCTION MOTOR
PERFORMANCE SPECIFICATIONS

INDEX	MPCF-1033
SHEET NO.	1 of 1
ISSUED	7/31/13
SUPERSEDES	11/8/96
REVISION	2
WRITTEN BY	MDC
APPROVED BY	PAA

CUSTOMER: -
TIC SR No.: -

MOTOR NAMEPLATE DATA

H.P.: -	VOLTS: 220/380	3 PH / 50 Hz	S. RPM: 1000
FRAME: 132M	ENCL: TEFC	FLAMPS: 21/11.9	FLRPM: 965
FORM: FBKL1	S.F.: -	IEC DESIGN N	INSUL CLASS: F
TYPE: IKKH	AMB.: 40°C	CODE: -	DUTY: Cont.
MODEL No.: Y556SDMV7HS-PL		kW: 5.5	
NOM. EFF.: 88.0	MIN. EFF.: -	cosØ 0.78	

AMPERAGE

LOCKED ROTOR: 142/82

TORQUES

FULL LOAD (lb-ft.): 40
LOCKED ROTOR (%): 245
BREAK DOWN (%): 335

****BEARINGS:**

DRIVE END: REFER TO NP
OPPOSITE DRIVE END: REFER TO NP

EFFICIENCY

FULL LOAD: 89.8
3/4 LOAD: 90.4
1/2 LOAD: 89.4

POWER FACTOR

FULL LOAD: 78.5
3/4 LOAD: 74.2
1/2 LOAD: 64.6

ALL CHARACTERISTICS ARE AVERAGE EXPECTED VALUES BASED UPON RATED VOLTAGE,
FREQUENCY AND SINEWAVE POWER INPUT.

THE DECLARED LOCKED ROTOR CURRENT HAS A TOLERANCE OF 20%.

* TEMPERATURE RISE WILL BE CONSISTENT WITH INSULATION, AMBIENT AND SERVICE FACTOR AS
DEFINED BY NEMA-MG-12 OR -20.

** BEARINGS ARE THE ONLY RECOMMENDED SPARE PART(S).

CERTIFIED BY: Zichao Xie

DATE: 7/31/2020

TOSHIBA INTERNATIONAL CORPORATION

Speed Torque/Current Curve

Model #:	Y556SDMV7HS-PL			FLAmps:	21/11.9
Enclosure:	TEFC	Voltage:	220/380 V	Frame:	132M
Pole:	6	Frequency:	3 PH / 50 Hz	Ins. Class:	F
KW:	5.5	Rotor Inertia:	2.0 lb-ft ²	Date:	7/31/2020
FLRPM:	965	Load Inertia:	N/A	File:	GH6Y55 (5.5kW)

Locked Rotor Amps:	142/82 A	Load Type:	N/A
Locked Rotor Torque:	245%	Starting at:	N/A
Breakdown Torque:	335%	Accel. Time:	N/A
Rated Torque:	40 lb-ft		

Design Values

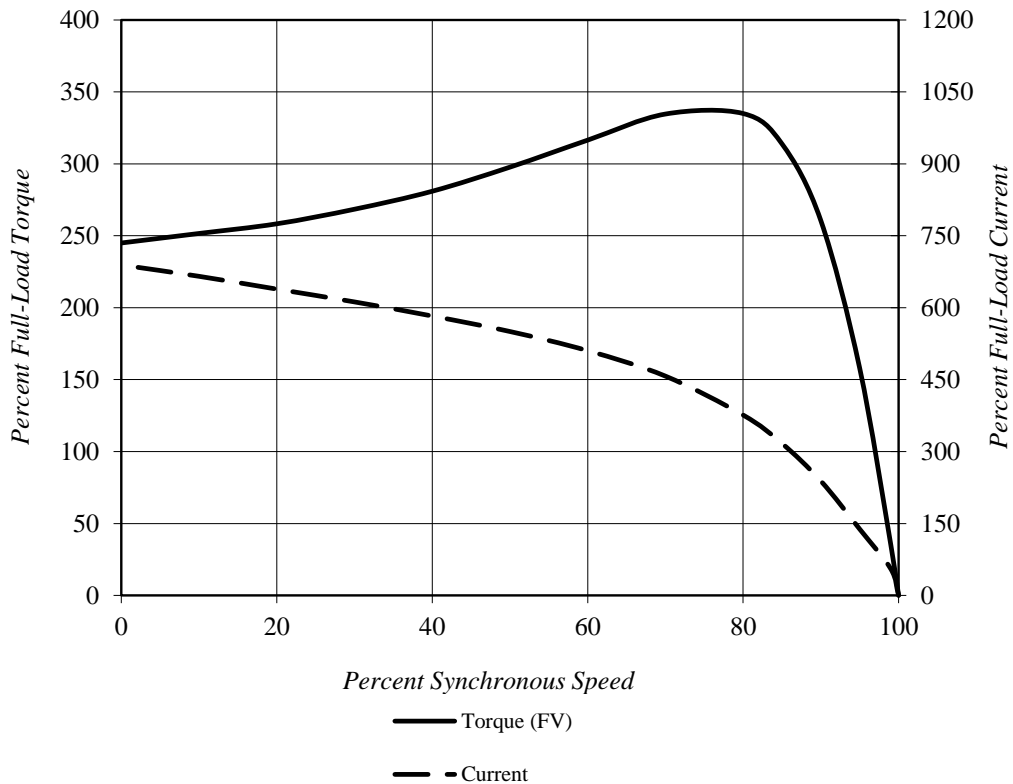

Comments: PROJECT -

D.E.Curve #: GH6Y55 (5.5kW)

Prepared by: Zichao Xie

Checked by:

TOSHIBA INTERNATIONAL CORPORATION

Thermal Limit & Acceleration Curves

Design Values (For Reference Only)

Model #:	Y556SDMV7HS-PL			FLAmps:	21/11.9
Enclosure:	TEFC	Voltage:	220/380 V	Frame:	132M
Pole:	6	Frequency:	3 PH / 50 Hz	Ins. Class:	F
KW:	5.5	Rotor Inertia:	2.0 lb-ft ²	Date:	7/31/2020
FLRPM:	965	Load Inertia:	N/A	File:	GH6Y55 (5.5kW)

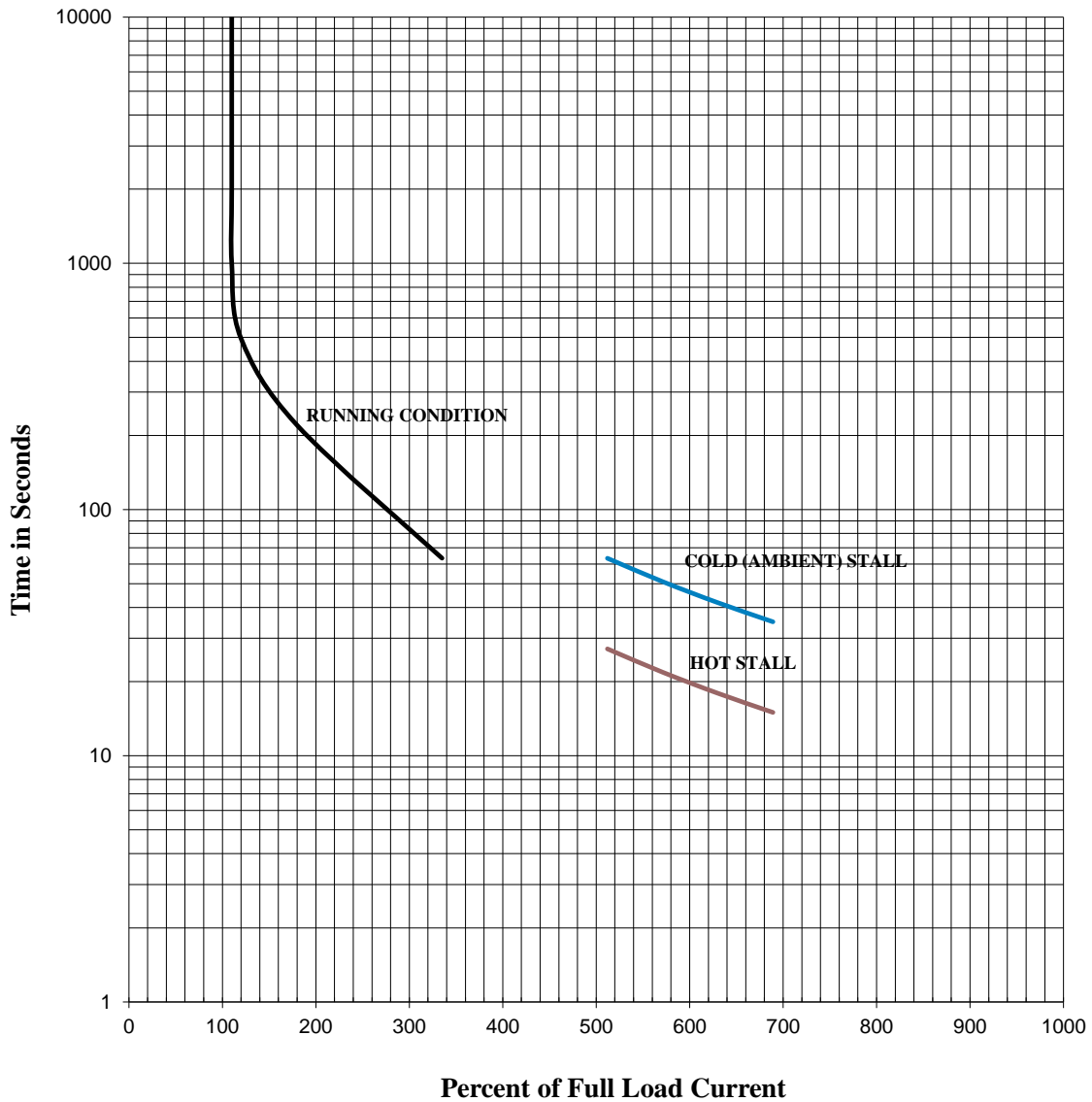

Comments: PROJECT _____

D.E. Curve #: GH6Y55 (5.5kW)

Prepared by: Zichao Xie

Checked by: _____

TOSHIBA INTERNATIONAL CORPORATION
Industrial Division / Houston Motor Plant

SQUIRREL CAGE INDUCTION MOTOR
PERFORMANCE SPECIFICATIONS

INDEX	MPCF-1033
SHEET NO.	1 of 1
ISSUED	7/31/13
SUPERSEDES	11/8/96
REVISION	2
WRITTEN BY	MDC
APPROVED BY	PAA

CUSTOMER: -
TIC SR No.: -

MOTOR NAMEPLATE DATA

H.P.: 7.5	VOLTS: 460	3 PH / 60 Hz	S. RPM: 1200
FRAME: 132M	ENCL: TEFC	FLAMPS: 10.2	FLRPM: 1175
FORM: FBKL1	S.F.: 1.15	NEMA DESIGN: A	INSUL CLASS: F
TYPE: IKKH	AMB.: 40°C	CODE: L	DUTY: Cont.
MODEL No.: Y556SDMV7HS-PL		kW: 5.5	
NOM. EFF.: 91.0	MIN. EFF.: -	P.F.: 74.0	

AMPERAGE

LOCKED ROTOR: 88

TORQUES

FULL LOAD (lb-ft.): 33
LOCKED ROTOR (%): 320
BREAK DOWN (%): 355

****BEARINGS:**

DRIVE END: REFER TO NP
OPPOSITE DRIVE END: REFER TO NP

EFFICIENCY

FULL LOAD: 91.5
3/4 LOAD: 91.0
1/2 LOAD: 89.0

POWER FACTOR

FULL LOAD: 74.1
3/4 LOAD: 68.4
1/2 LOAD: 57.4

ALL CHARACTERISTICS ARE AVERAGE EXPECTED VALUES BASED UPON RATED VOLTAGE,
FREQUENCY AND SINEWAVE POWER INPUT.

THE DECLARED LOCKED ROTOR CURRENT HAS A TOLERANCE OF 20%.

* TEMPERATURE RISE WILL BE CONSISTENT WITH INSULATION, AMBIENT AND SERVICE FACTOR AS
DEFINED BY NEMA-MG-12 OR -20.

** BEARINGS ARE THE ONLY RECOMMENDED SPARE PART(S).

CERTIFIED BY: Zichao Xie

DATE: 7/31/2020

TOSHIBA INTERNATIONAL CORPORATION

Speed Torque/Current Curve

Model #:	Y556SDMV7HS-PL			FLAmps:	10.2
Enclosure:	TEFC	Voltage:	460 V	Frame:	132M
Pole:	6	Frequency:	3 PH / 60 Hz	Ins. Class:	F
HP:	7.5	Rotor Inertia:	2.0 lb-ft ²	Date:	7/31/2020
FLRPM:	1175	Load Inertia:	N/A	File:	GH6Y55 (5.5kW)

Locked Rotor Amps:	88 A	Load Type:	N/A
Locked Rotor Torque:	320%	Starting at:	N/A
Breakdown Torque:	355%	Accel. Time:	N/A
Rated Torque:	33 lb-ft		

Design Values

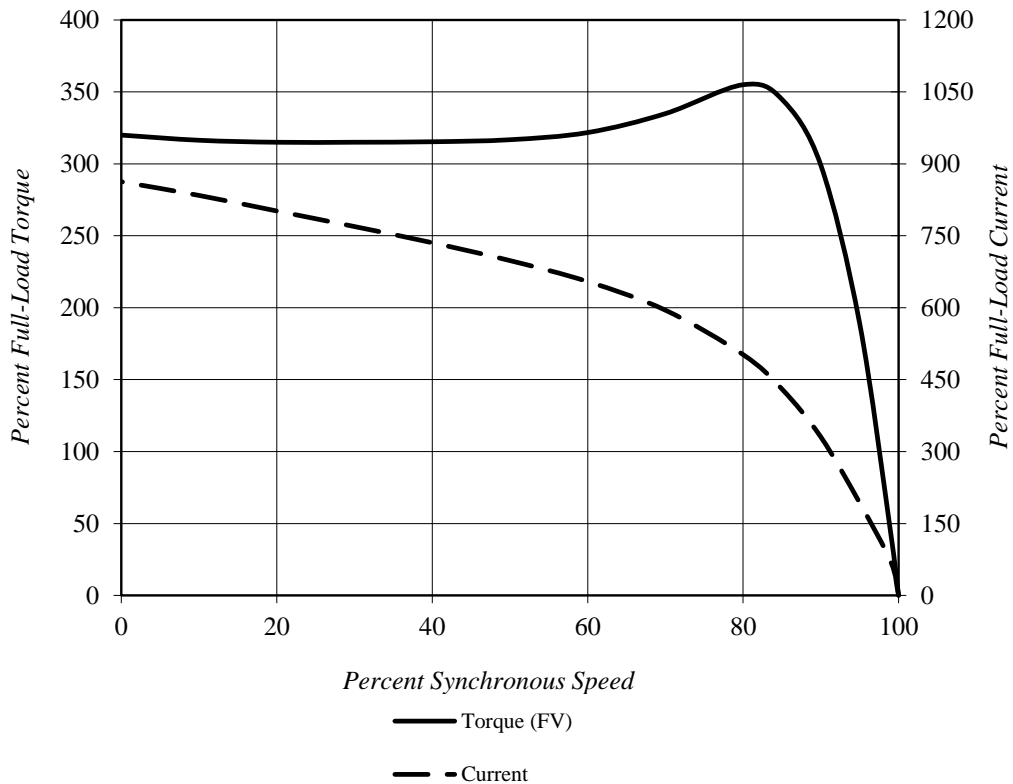

Comments: PROJECT -

D.E. Curve #: GH6Y55 (5.5kW)

Prepared by: Zichao Xie

Checked by:

TOSHIBA INTERNATIONAL CORPORATION

Thermal Limit & Acceleration Curves

Design Values (For Reference Only)

Model #:	Y556SDMV7HS-PL			FLAmps:	10.2
Enclosure:	TEFC	Voltage:	460 V	Frame:	132M
Pole:	6	Frequency:	3 PH / 60 Hz	Ins. Class:	F
HP:	7.5	Rotor Inertia:	2.0 lb-ft ²	Date:	7/31/2020
FLRPM:	1175	Load Inertia:	N/A	File:	GH6Y55 (5.5kW)

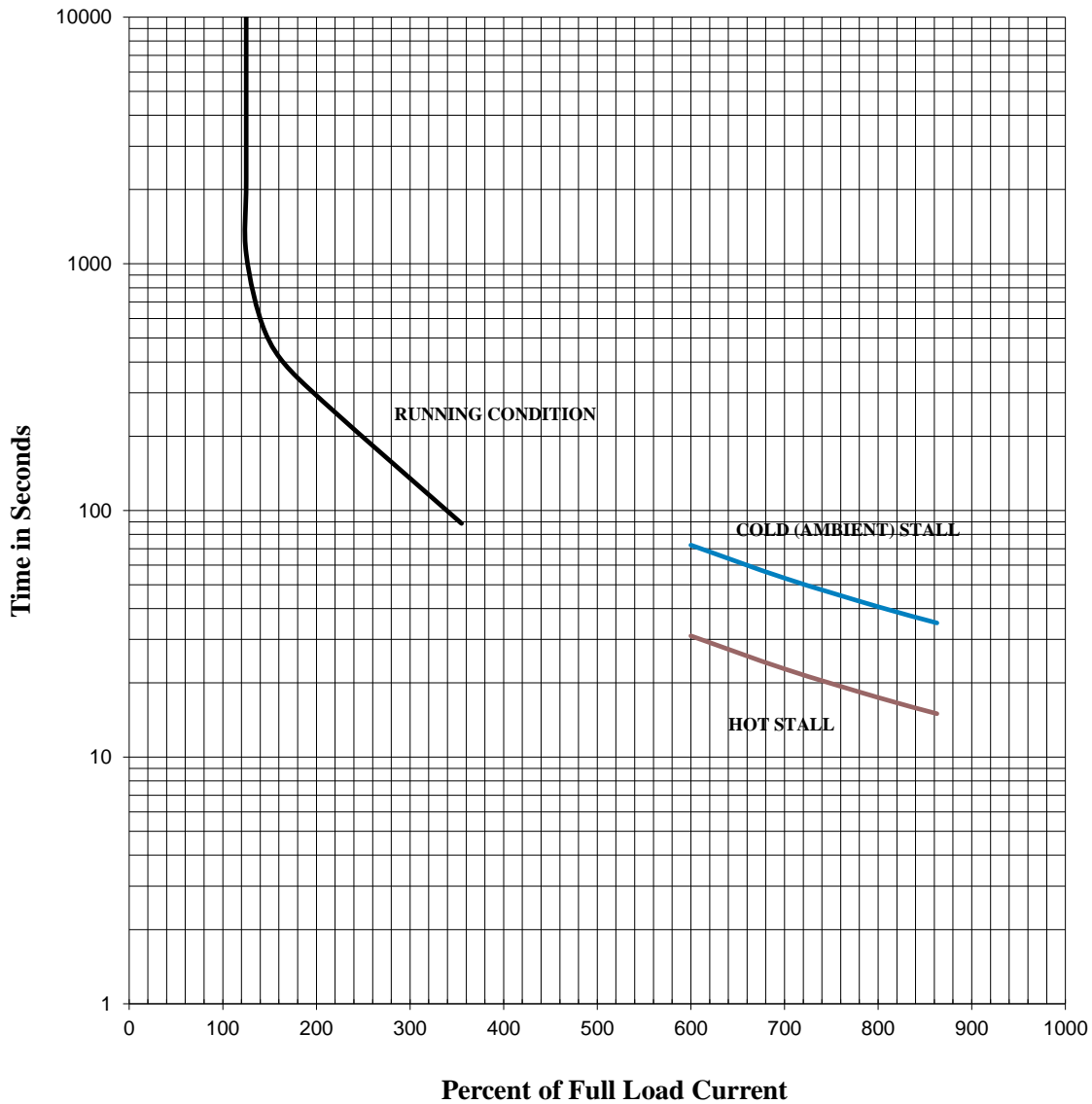

Comments: PROJECT -

D.E. Curve #: GH6Y55 (5.5kW)

Prepared by: Zichao Xie

Checked by: