

4300 SERIES

INSTALLATION AND OPERATION MANUAL

THREE PHASE - 30/50 KVA



Part # 64524-009
December 2015

Manufactured in the USA



4300 SERIES

INSTALLATION AND OPERATION MANUAL THREE PHASE - 30/50 KVA

Part # 64524-009
December 2015



Product Use and Warranty Restrictions

The Toshiba products listed in this document are intended for usage in general electronics applications (computer, personal equipment, office equipment, measuring equipment, industrial robotics, domestic appliances, etc.). These Toshiba products are neither intended nor warranted for usage in equipment that requires extraordinarily high quality and/or reliability or where a malfunction or failure may cause loss of human life or bodily injury (Unintended Usage). Unintended Usage includes atomic energy control instruments, airplane or spaceship instruments, transportation instruments, traffic signal instruments, combustion control instruments, life-support equipment, all types of safety devices, etc. Unintended Usage of Toshiba products listed in this document shall be made at the customer's own risk.

NOTICE

PLEASE INFORM TOSHIBA INTERNATIONAL CORPORATION OR AUTHORIZED REPRESENTATIVE IN CASE OF INCONSISTENCIES, OMISSIONS, OR QUESTIONS.

The instructions contained in this manual are not intended to cover all of the details or variations in equipment, or to provide for every possible contingency concerning installation, operation, or maintenance. Should further information be required or if problems arise which are not covered sufficiently, contact your Toshiba sales office.

The contents of this instruction manual shall not become a part of or modify any prior or existing agreement, commitment, or relationship. The sales contract contains the entire obligation of Toshiba International Corporation UPS Division. The warranty contained in the contract between the parties is the sole warranty of Toshiba International Corporation UPS Division and any statements contained herein DO NOT create new warranties or modify the existing warranty.

Any electrical or mechanical modifications to this equipment without prior written consent of Toshiba International Corporation will void all warranties and may void the UL/CUL listing. Unauthorized modifications can also result in personal injury, loss of life, or destruction of the equipment.

QUALIFIED PERSONNEL ONLY

Qualified Personnel are those who have the skills and knowledge relating to the construction, installation, operation, and maintenance of the electrical equipment and have received safety training on the hazards involved (Refer to the latest edition of NFPA 70E for additional safety requirements).

UNINTERRUPTIBLE POWER SYSTEM (UPS)

Please complete the following information and retain for your records.

Unless otherwise specified, the warranty period for the UPS or UPS part is 36 months from the shipment date (see Toshiba International Corporation bill of lading).

Unless otherwise specified, the warranty period for a UPS battery is 24 months from the shipment date (see Toshiba International Corporation bill of lading).

JOB NUMBER	_____
MODEL NUMBER	_____
SERIAL NUMBER	_____
APPLICATION	_____
SHIPMENT DATE	_____
INSTALLATION DATE	_____
INSPECTED BY	_____

Purpose

This manual provides information on how to safely install your Toshiba International Corporation power electronics product. This manual includes a section of general safety instructions that describes the warning labels and symbols that are used throughout the manual. Read the manual completely before installing, operating, or performing maintenance on this equipment.

This manual and the accompanying drawings should be considered a permanent part of the equipment and should be readily available for reference and review. Dimensions shown in the manual are in metric and/or the English customary equivalent.

Toshiba International Corporation reserves the right, without prior notice, to update information, make product changes, or discontinue any product or service identified in this publication.

Toshiba is a registered trademark of the Toshiba Corporation. All other product or trade references appearing in this manual are registered trademarks of their respective owners.

Toshiba International Corporation shall not be liable for direct, indirect, special, or consequential damages resulting from the use of the information contained within this manual.

This manual is copyrighted. No part of this manual may be photocopied or reproduced in any form without the prior written consent of Toshiba International Corporation.

© Copyright 2015 Toshiba International Corporation
All rights reserved.
Printed in the U.S.A.

Toshiba Customer Support Center

Contact the Toshiba Customer Support Center for assistance with application information or for any problems that you may experience with your Uninterruptible Power System (UPS).

Toshiba Customer Support Center

8 a.m. to 5 p.m. (CST) - Monday through Friday

USA Toll Free (877) 867-8773

Tel (713) 466-0277

Fax (713) 466-8773

E-mail – ToshibaUPS@tic.toshiba.com

Web – <https://www.toshiba.com/tic/industrial/uninterruptible-power-systems>

You may also contact Toshiba by writing to:

Toshiba International Corporation

13131 West Little York Road

Houston, Texas 77041-9990

Attn: UPS Product Manager

For additional information on Toshiba products and services, please visit our website at:

<https://www.toshiba.com/tic/industrial/uninterruptible-power-systems>

Contents

1	Introduction	1
2	General Safety Instructions	2
2.1	Symbols.....	2
2.2	Signal Words.....	3
2.3	Qualified Personnel.....	3
2.4	Factory Authorized Personnel.....	4
3	Important Safety Instructions	4
4	Safety Precautions	5
4.1	Disclaimer.....	5
4.2	General Maintenance.....	5
4.3	Transporting.....	6
4.4	Transporting By Forklift.....	7
4.5	Inspection/Storage.....	8
5	Installation Precautions	9
5.1	Wiring/Connection.....	11
6	Warning Labels	12
7	Storage/Operating Environment	14
7.1	Storage Environment.....	14
7.2	Operating Precautions.....	14
7.3	Maintenance Precautions.....	16
8	Installation	17
8.1	Unpacking.....	18
8.2	UPS Clearance.....	18
8.3	Anchor Bolts.....	19
8.4	Power Cable Knockout Plates.....	20
8.5	UPS Parts Identification.....	21
9	UPS Wiring	23
9.1	One-Line Diagram.....	23
9.2	Multiple Battery Cabinets.....	25
9.3	30/50 kVA Terminal Blocks and Power Cables.....	25
9.4	TB3 - Control Wiring.....	26
9.5	External Breakers.....	27
9.6	Grounding Wire.....	27
10	Communication Interfaces	28
10.1	Remote Contacts.....	28
10.2	RS-232C.....	29
10.3	RemotEye Network Card.....	30
10.4	Optional Kickplate Installation.....	30

11	Specifications	31
11.1	Specification Table	31
11.2	Typical Efficiency vs. Load.....	33
11.3	Typical Thermal Loss vs. Load.....	33
12	Operator Interface	34
12.1	Operator Controls	34
12.2	Operator Controls - Light Emitting Diodes (LED).....	35
12.3	Operator Controls	36
12.4	Touch Screen Display	37
12.5	Header Bar	38
12.6	Footer Bar.....	38
12.7	Quick Access Toolbar	39
12.8	4300 Menu Tree	41
12.9	Toolbar: Security.....	42
12.10	Toolbar: Buzzer ON/OFF	42
12.11	Toolbar: Touch ON/OFF	42
12.12	Toolbar: QUICK VIEW ON/OFF.....	43
12.13	Tab: Main	44
12.14	Tab: Monitor	45
12.15	Tab: Setup.....	47
12.16	Setup: Calibrating the Touchscreen.....	49
12.17	Tab: Record	50
12.18	Tab: Help.....	51
12.19	4300 Parameter Definitions	52
12.20	System Fault Messages	58
12.21	System Warning Messages	59
12.22	System Mode Messages	61
12.23	System Status Messages	61
13.	UPS Operation	63
13.1	Initial UPS Startup	63
13.2	Starting/Stopping the UPS.....	64
13.3	Stopping the UPS	64
13.4	Battery Backup Time and Discharge Process	65
13.5	Battery Low Voltage Tolerances	66
13.6	Battery Equalize Charge Mode.....	66
13.7	Audible Alarm Functions	67
14	Options	68
14.1	Ancillary Cabinets: Transformer, UPS, Battery.	68
14.2	4300 Options	68
15	External Layouts/Dimensions/Shipping Weights.....	69
	Appendix A - Installation Planning Guide	73
	Appendix B - Optional Kickplate Installation.....	75
	Appendix C - Optional Air Filters	79

1 Introduction

This manual provides information on how to safely operate your 4300 Series Uninterruptible Power System (UPS). This manual includes a section of general safety instructions that describes the warning labels and symbols that are used throughout the manual. Read the manual completely before installing, operating, or performing maintenance on this equipment.

Qualified personnel should read this manual carefully before transporting, installing, and wiring the UPS. In addition they have a thorough understanding of the information provided in the chapters titled:

- General Safety Instructions
- Important Safety Instructions
- Safety Precautions
- Installation Precautions

Please read the 4300 Series Operation Manual for important instructions on operating the UPS. This manual and the accompanying drawings should be considered a permanent part of the equipment and should be readily available for reference and review. Dimensions shown in the manual are in metric and/or the English customary equivalent.

Keep the Installation Manual and the Operation Manual near the UPS for necessary reference.

SAVE THESE INSTRUCTIONS

2 General Safety Instructions

DO NOT attempt to transport, install, operate, maintain or dispose of this equipment until you have read and understood all of the product safety information provided in this manual.

2.1 Symbols

The symbols listed below are used throughout this manual. When symbols are used in this manual they will include important safety information that must be carefully followed.



Safety Alert Symbol indicates that a potential personal injury hazard exists.



Prohibited Symbol indicates **DO NOT** take action.



Mandatory Symbol indicates that the following instruction is required.



Ground Symbol indicates the location of the equipment grounding conductor.



Electrical - Voltage & Shock Hazard Symbol indicates parts inside may cause electric shock.



Explosion Hazard Symbol indicates parts may explode.

2.2 Signal Words

The signal words listed below are used throughout this manual. When the words DANGER, WARNING, CAUTION and ATTENTION are used in this manual they will include important safety information that must be carefully followed.



The word **DANGER** in capital letters preceded by the safety alert symbol indicates that an **imminently hazardous** situation exists, and if not avoided **will result in loss of life or serious injury to personnel**.



The word **WARNING** in capital letters preceded by the safety alert symbol indicates that a **potentially hazardous** situation exists, and if not avoided **may result in loss of life or serious injury to personnel**.



The word **CAUTION** in capital letters preceded by the safety alert symbol indicates that a **potentially hazardous** situation exists, and if not avoided **may result in minor or moderate injury**.



The word **NOTICE** in capital letters without the safety alert symbol indicates a **potentially hazardous** situation exists, and if not avoided **may result in equipment and property damage**.

2.3 Qualified Personnel

Installation, operation, and maintenance shall be performed by Qualified Personnel Only. A Qualified Person is one that has the skills and knowledge relating to the construction, installation, operation, and maintenance of the electrical equipment and has received safety training on the hazards involved (Refer to the latest edition of NFPA 70E for additional safety requirements).

Qualified Personnel shall:

- Have read the entire operation manual.
- Be familiar with the construction and function of the UPS, the equipment being driven, and the hazards involved.
- Be trained and authorized to safely energize, de-energize, ground, lockout/tagout circuits and equipment, and clear faults in accordance with established safety practices.
- Be trained in the proper care and use of protective equipment such as safety shoes, rubber gloves, hard hats, safety glasses, face shields, flash clothing, etc., in accordance with established safety practices.
- Be trained in rendering first aid.

For further information on workplace safety visit www.osha.gov.

2.4 Factory Authorized Personnel

Factory authorized personnel have been factory trained and certified to install, service, and repair the UPS. Contact the Toshiba Customer Support Center for assistance in locating the factory authorized personnel nearest you.

3 Important Safety Instructions

The following contains important instructions that should be followed during the installation, operation, and maintenance of the 4300 Series UPS.

CAUTION

Misuse of this equipment could result in personal injury and/or equipment damage. In no event will Toshiba Corporation be responsible or liable for either indirect or consequential damage or injury that may come from the use of this equipment.

The UPS system input and output is NOT equipped with an over-current protection device, or an output disconnect at the AC output. The user should provide circuit breakers between the UPS AC input (or Bypass input) and the power sources and between the UPS output and the critical load input. The minimum device ratings are listed in Table 3.1.

TABLE 3.1 UPS MINIMUM DEVICE RATINGS

CAPACITY	RATED OUTPUT	INPUT BREAKER RATING	OUTPUT BREAKER RATING
30 kVA	208 V/120 V	208/120 V – 125 A	208/120 V – 125 A
50 kVA	208 V/120 V	208/120 V – 200 A	208/120 V – 200 A

The maximum operating ambient temperature for the UPS is 104 °F (40 °C) at 0.9 PF.

If the UPS is exposed to the same ambient temperature as the DC backup supply, the maximum operating ambient temperature is:

- Battery backup: 90 °F (32 °C) at 0.9 PF. Table 3.2 lists the nominal battery voltage.

TABLE 3.2 UPS NOMINAL BATTERY VOLTAGE

CAPACITY	NOMINAL VOLTAGE	FLOAT VOLTAGE
30 kVA	288 Vdc	324 V
50 kVA	288 Vdc	324 V

4 Safety Precautions

The Toshiba products listed in this document are intended for usage in general electronics applications (computer, personal equipment, office equipment, measuring equipment, industrial robotics, domestic appliances, etc.). These Toshiba products are neither intended nor warranted for use in equipment that, if a malfunction or failure occurs, may result in loss of human life or bodily injury (collectively referred to as “Unintended Usage”). Unintended Usage includes atomic energy control instruments, airplane or spaceship instruments, transportation instruments, traffic signal instruments, combustion control instruments, medical operating room or life support equipment, all types of safety devices, etc. Unintended Usage of Toshiba products listed in this document shall be made at the customer’s own risk.



The application of the UPS without special consideration for equipment that supports human safety and/or maintain public services may cause serious accidents.

4.1 Disclaimer









IN NO EVENT WILL TOSHIBA CORPORATION BE RESPONSIBLE OR LIABLE FOR EITHER INDIRECT OR CONSEQUENTIAL DAMAGE OR INJURY THAT MAY COME FROM THE MISUSE OF THIS EQUIPMENT. ANY MODIFICATIONS WITHOUT AUTHORIZATION BY TOSHIBA COULD RESULT IN PERSONAL INJURIES, DEATH OR DESTRUCTION OF THE UPS.

TOSHIBA RESERVES THE RIGHT TO MAKE CHANGES WITHOUT FURTHER NOTICE TO ANY PRODUCTS HEREIN TO IMPROVE RELIABILITY, FUNCTION OR DESIGN. TOSHIBA DOES NOT ASSUME ANY LIABILITY ARISING OUT OF THE APPLICATION OR USE OF ANY PRODUCT OR UPS DESCRIBED HEREIN; NEITHER DOES IT CONVEY ANY LICENSE UNDER ITS PATENT RIGHTS, NOR THE RIGHTS OF OTHERS.

4.2 General Maintenance

 WARNING	
	<p>DO NOT remove the rear/side panels, or any sheet metal not designed to be removed.</p> <p>Removing rear/side panels may result in electric shock, burns, personal injuries or UPS failure.</p>
	<p>Keep the area around the UPS clean.</p> <p>Use a vacuum cleaner to clean the UPS.</p>
	<p>Only factory authorized personnel should perform internal general maintenance on the UPS.</p>
	<p>Contact the authorized Toshiba Customer Support Center or an authorized Toshiba representative for information on proper disposal of UPS components.</p> <p>It is illegal to dispose of certain components without conforming to environmental regulations for industrial/commercial waste.</p>

4.3 Transporting

 WARNING	
	<p>DO NOT tilt the UPS more than 10° from upright position. Tilting the UPS more than 10° may cause crushing, trapping or other personal injuries.</p>
 CAUTION	
	<p>DO NOT transport, move, store, or place the UPS on its side. Excessive force applied from heavy components inside may damage the UPS.</p>
	<p>Avoid vibration or shock exceeding 0.5 g. Failing to observe this precaution may cause damage to the UPS.</p>
	<p>DO NOT allow the UPS to suffer shock or impact when unpacking. Tools used to remove packaging materials may cause damage to the UPS.</p>
	<p>DO NOT install the UPS where water may fall on it. Water may cause electrical shock, personal injury or UPS failure.</p>
	<p>DO NOT push or pull on the sides of the packaging or the UPS to move it. Always use a crane, forklift, or pallet jack for transporting and positioning the UPS. Pushing/pulling on the sides of the unit to move it may result in damage to the UPS. (See Figure 4.1 Exterior Handling label.)</p>

The UPS may be packed in a crate for extra protection during transportation. Avoid impact or vibration against the UPS during transportation. DO NOT expose the UPS directly to water.

4.4 Transporting By Forklift

Refer to Chapter 15 - Weight and Dimensions.

Verify forklift maximum load capacity and ensure that the forks are long enough to properly support the UPS. Insert the forks into the space shown in Figure 4.1. Spaces for the forks are provided underneath the UPS.

DO NOT tilt UPS when lifting and/or transporting. Minimize the impact when lowering the UPS to the floor.

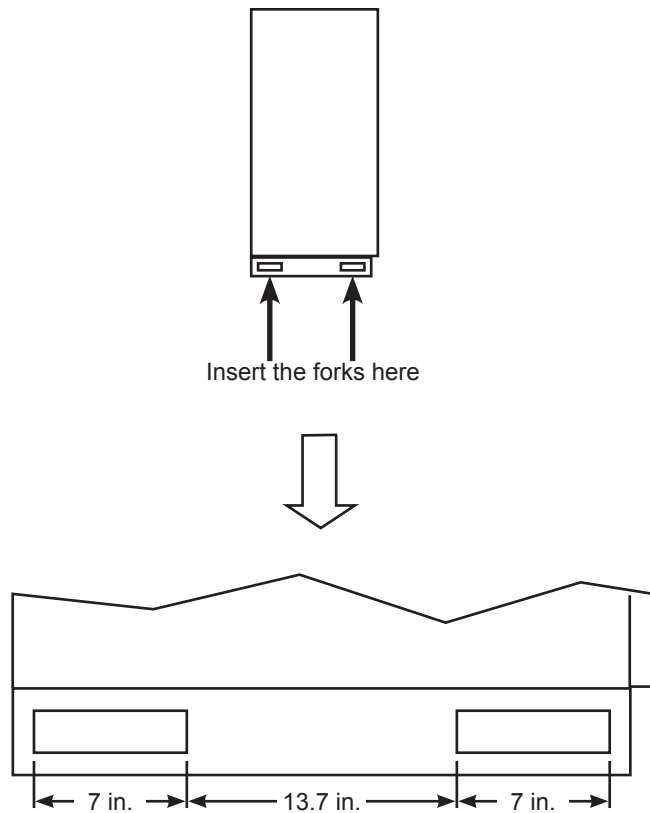

4300 Side View - Fork Access
Dimensions in Channel Base

FIGURE 4.1 -TRANSPORTING UPS BY FORKLIFT

4.5 Inspection/Storage

Inspection

Upon receipt of the UPS, an inspection for shipping damage should be performed. Use caution when removing the unit from the pallet. Refer to labels or documentation attached to packing material.

Unpacking

Check the unit for loose, broken, bent or otherwise damaged parts. If damage has occurred during shipping, keep all original crating and packing materials for return to the shipping agent.

NOTE: The factory warranty does not apply to damage incurred during shipping!

Ensure that the rated capacity and the model number specified on the nameplate conform to the order specifications.

Storage

During periods of non-use, the following guidelines are recommended for storage.

Storage Preparation

- 1) If the UPS has a battery backup, power up the UPS and allow it to operate with no load for 24 hours to fully charge the batteries.
- 2) Stop the UPS.
- 3) Place the UPS Main Circuit Breaker switch in the "OFF" position.







Storage Conditions

- For best results, store the UPS in the original shipping container and place on a wood or metal pallet
- Storage temperature range: -4 to 104 °F (-20 to 40 °C)
- The optimum storage temperature is 70 °F (21 °C). A higher ambient temperature will require recharging more frequently during storage

Avoid the following storage locations:

- Locations that are subject to extreme temperature changes or high humidity
- Locations that are subject to high levels of dust or metal particles
- Locations that are subject to excessive vibration
- Inclined floor surfaces

5 Installation Precautions

 CAUTION	
	<p>Install the UPS in a controlled environment.</p> <p>Improper storage and installation environment may deteriorate insulation, shorten component life and cause malfunctions.</p> <p><i>See Table 5.1 - UPS Installation Environment Standards</i></p>
	<p>DO NOT tilt the UPS more than 10° from upright position.</p> <p>Tilting the UPS more than 10° may cause crushing, trapping or other personal injuries and cause physical damage to internal components.</p>
 WARNING	
	<p>Keep the SPECIFIED CLEARANCE around the UPS.</p> <p>Inadequate space around the UPS makes it difficult to perform maintenance/inspections, will lead to insufficient ventilation, and/or cause malfunctions.</p>
	<p>Install anchor bolts to secure the UPS to the installation floor.</p> <p>The UPS may fall during an earthquake if the anchor bolts are not installed and secured.</p>
	<p>Only factory authorized personnel should relocate, modify, or replace parts in the UPS after initial installation.</p> <p>Electrical shock, injury or UPS failure may occur if non-authorized technicians attempt to modify or relocate the UPS.</p> <p>Please contact Toshiba Customer Support Center if you plan to move or make modifications to the UPS</p>

- 1) The UPS generates and can radiate radio-frequency energy during operation. Although RFI noise filters are installed inside of the unit, there is no guarantee that the UPS will not influence some sensitive devices that are operating near by. If such interference is experienced, the UPS should be installed further away from the affected equipment and/or powered from a different source than that of the installed equipment.
- 2) The user should provide over-current protection for hardwired UPS systems between the UPS output and the load input.
- 3) After ensuring that all power sources are turned “OFF” and isolated in accordance with established lockout/tagout procedures, connect the power source wiring of the correct voltage to the input terminals of the UPS.

NOTE: Ensure the input phasing is connected in clockwise rotation (CW). UPS internal circuitry is designed to disable further UPS operation if the input phasing is installed in counter-clockwise rotation (CCW).





- 4) Connect the output terminals of the UPS to the load (refer to NEC Article 300 - Wiring Methods and Article 310 - Conductors For General Wiring). Size the branch circuit conductors in accordance with NEC Table 310.16 as published 9/2008.

 WARNING	
	METAL CONDUIT IS NOT AN ACCEPTABLE GROUND.

Conductor Routing and Grounding

- 1) Use separate metal conduits for routing the input power, output power, and control circuits.
- 2) Follow the wire size and tightening torque specifications.
- 3) Always ground the unit to reduce the potential for electrical shock and to help reduce electrical noise.
- 4) A separate ground cable should be run inside the conduit with the input power, output power, and control circuits.

5.1 Wiring/Connection

 WARNING	
	<p>Perform wiring and connections with correct polarity.</p> <p>Be careful when connecting the UPS to the DC backup system. A wrong connection may cause damage to the UPS, DC backup system, or charger.</p>
	<p>Connect ONLY one (1) ground wire to the earth ground terminal.</p> <p>A missing ground wire may cause an electrical shock hazard. Connecting to more than one ground may cause a ground loop.</p> <p><i>See Chapter 9 - UPS Wiring</i></p>
	<p>DO NOT force, bend, or pull wires.</p> <p>DO NOT damage wire insulation.</p> <p>DO NOT place heavy objects on top of UPS.</p>
	<p>Observe the above precautions when making wire connections or handling the wires. Failing to observe these precautions may damage the insulation of the wires or may cause a fire or an electric shock hazard.</p>
NOTICE	
<p>Follow the torque criteria for tightening screws.</p> <p>Loose connections may cause fire due to heating.</p> <p><i>See Chapter 9 - UPS Wiring</i></p>	

6 Warning Labels

Below are representative warning labels and their location on the UPS.

NOTICE

Make sure all the warning labels are installed in the appropriate locations.

If a label is missing or illegible, contact Toshiba Customer Support Center or an authorized representative.

A

⚠ DANGER

HAZARDOUS VOLTAGES
Hazardous voltages are used in the operation of this equipment and could cause severe personal injury or loss of life.
The following precautions should be observed to reduce the risk of injury or death.

Only qualified technicians familiar with this equipment and the information supplied with it should be permitted to install and operate this equipment.

Installation of electrical equipment must be done in accordance with National Electrical Code and any other state or local codes. Proper grounding and conductor sizing must be installed for safe operation.

During operation, keep all covers in place and cabinet doors shut.

When performing visual inspections and maintenance, if possible, be sure the UPS is turned off and the incoming AC feed is turned off and locked out.

The UPS and Battery Cabinet will have hazardous voltages present even after the AC feed is turned off.

If it is necessary to make measurements with the power on, do not touch any electrical connection points. Remove all jewelry from wrists and fingers. Make sure test equipment is in good, safe operating condition.

While servicing, stand on some type of insulation, and be sure not to be grounded.

Follow the safety instructions given in the equipment manual carefully and observe all danger, warning and caution notices.

40308

B

⚠ DANGER

RISK OF ELECTRIC SHOCK
Capacitors stay charged after power has been shut off.
Accidental contact with live parts can cause personal injury and death.
Turn off and lock out all power sources.
Wait at least five (5) minutes for power to dissipate then check voltage before servicing.

39561

C

⚠ WARNING

CRITICAL FUSE SIZING
Incorrect fuse replacement size may result in fire or inadequate equipment protection.
Replace only with same type and rating of fuse.

PN 40830

D

40° AMBIENT
TEMPERATURE

FIGURE 6.1 – 50 KVA UPS WARNING LABELS

The warning labels identified on the previous page are located on the front and interior of the UPS. Their location is shown in Figures 6.2 - 6.3.



FIGURE 6.2 – EXTERNAL WARNING LABEL LOCATIONS

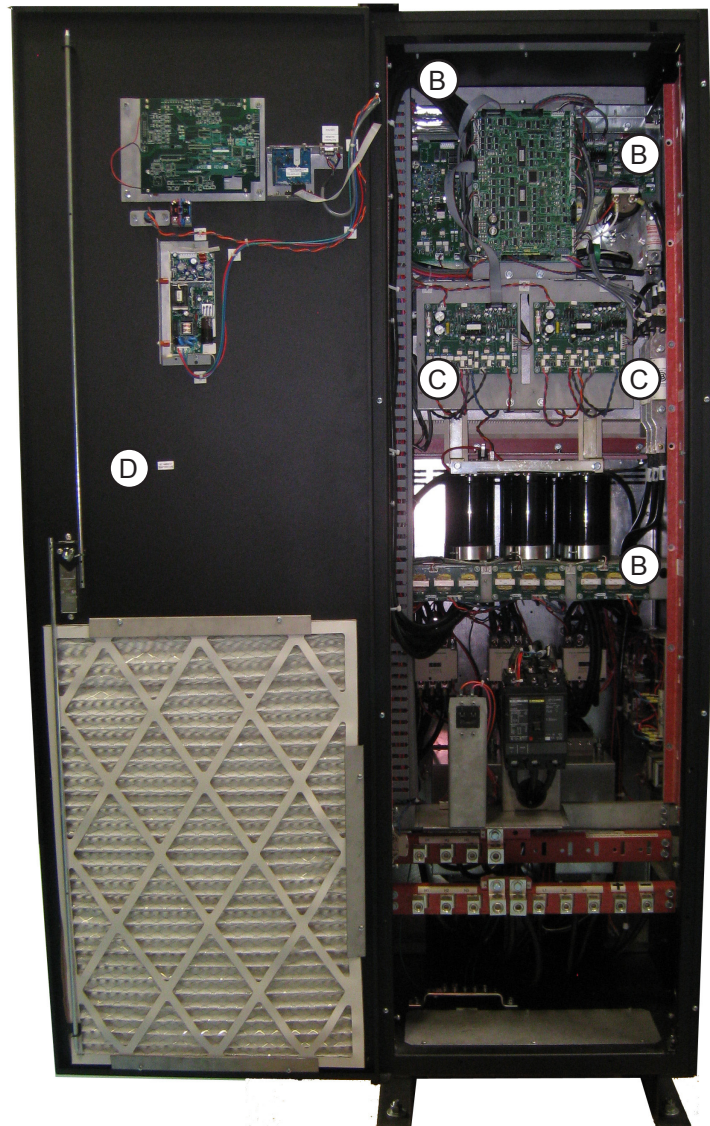

FIGURE 6.3 – INTERNAL WARNING LABEL

7 Storage/Operating Environment

7.1 Storage Environment

Observe the following when storing the UPS.

- Store UPS indoors.
- Maximum storage time for the UPS between powered operation cycles is three years. If the UPS has been stored for a period exceeding 36 months, contact your factory authorized representative of guidance in starting the unit.
- Temperature fluctuations should be minimized.
- The optimal storage temperature range is 68 – 77 °F (20 – 25° C).
- A maximum temperature range of 32 – 104 °F (0 – 40 °C) should be observed.
- The optimal relative humidity at the storage location should be between 50 – 60%.
- Humidity must not exceed 90%.
- Avoid locations where UPS may be exposed to corrosive gas.
- Avoid locations with dirt and/or dust.



TABLE 7.1 - UPS STORAGE/OPERATING ENVIRONMENT STANDARDS



Item	Environment standard	
Storage Location	Indoors	
Ambient Temperature	Minimum storage temperature: 32 °F (0 °C)	
	Maximum storage temperature: 104 °F (40 °C)	
Relative Humidity	The relative humidity must be between 30 and 90% and without condensation due to temperature changes.	
Altitude	This equipment is rated for installations up to 3240 ft. (1000 m) above sea level. Consult with the factory to determine the derating factor for installations above 3240 ft. (1000 m).	
Dust	Dust must not exceed normal atmospheric levels and must not include conductive particles, silicone or oils.	
Flammable Gas	No flammable and/or explosive gas.	
	Hydrogen sulfide (H ₂ S)	Less than or equal to 0.0001 PPM
	Sulfurous acid gas (SO ₂)	Less than or equal to 0.05 PPM
	Chlorine gas (Cl ₂)	Less than or equal to 0.002 PPM
	Ammonia gas (NH ₃)	Less than or equal to 0.1 PPM
	Nitrous acid gas (NO ₂)	Less than or equal to 0.02 PPM
	Nitrous oxides (NO _x)	Less than or equal to 0.02 PPM
	Ozone (O ₃)	Less than or equal to 0.002 PPM
	Hydrochloric acid mist (HCl)	Less than or equal to 0.1 mg/m ³

7.2 Operating Precautions

Initial startup/commissioning of the UPS should be performed by factory authorized personnel.

- 1) The UPS should not be powered up until the entire operation manual has been read.
- 2) The voltage of the input power source must be within the rated input voltage range. The input frequency range must be within the rated input frequency range.
- 3) The UPS should not be used with a load that has a rated input that is greater than the rated output of the UPS.
- 4) If using the UPS to provide power to motors that require high starting current or with motors that require a long starting time, call Toshiba support for guidance in over sizing the UPS for lock rotor current.
- 5) DO NOT insert metal objects or combustible materials in the ventilation slots of the UPS.
- 6) DO NOT place, hang, or paste any objects on the exterior surfaces of the UPS.
- 7) The capacitors in the UPS maintain a residual charge for a while after turning the UPS off. The required discharge time for each UPS typeform is provided via a cabinet label and a **CHARGE LED**. Wait for at least the minimum time indicated on the label and ensure that the **CHARGE LED** has gone out before opening the door of the UPS once the UPS power has been turned off.
- 8) DO NOT attempt to disassemble, modify, or repair the UPS. Call your Toshiba sales representative for repair information.
- 9) Turn the power on only after installing **ALL** of the covers.
- 10) DO NOT remove any covers of the UPS when power is on.
- 11) If the UPS should emit smoke or an unusual odor or sound, turn the power off immediately.
- 12) Warning signs should be placed on or near the load as a notification that the load is being powered by the UPS.
- 13) Additional warnings and notifications shall be posted at the equipment installation location as deemed required by **Qualified Personnel**.

 WARNING	
	<p>While operating in the inverter mode, placing the input breaker in the “OFF” position will switch the UPS to the DC supply backup mode.</p> <p>The output of the UPS will continue uninterrupted to the load. The unit must be in the bypass mode at the time that the breaker is placed in the “OFF” position for the UPS to shutdown power to the load.</p>

 CAUTION	
	<p>After an Emergency Power Off (EPO), DO NOT reset the breaker until the UPS internal circuits have been fully discharged.</p> <p>The UPS could be damaged if the unit is not fully discharged before the breaker is reset.</p>

7.3 Maintenance Precautions

All internal maintenance should be performed by factory authorized personnel.

- 1) Turn off, lockout, and tagout ALL power sources before connecting the power wiring to the equipment or when performing maintenance.
- 2) Hardwire type UPS units are not equipped with an over-current protection device, nor do they have an output disconnect for the AC output. A user-installed circuit breaker should be provided between the UPS output and the load input.
- 3) The maximum ambient operating temperature is 86 °F (30 °C) at 1.0 PF, and 104 °F (40 °C) at 0.8 PF.
- 4) Only factory authorized personnel should service the UPS. Contact Toshiba for the nearest authorized service center.
- 5) Battery/Flywheel servicing should be performed by factory authorized personnel only.

Note: Contact your nearest factory authorized service center for battery replacement.



Qualified Personnel ONLY!

Qualified Personnel have the skills and knowledge relating to the construction, installation, operation, and maintenance of the electrical equipment and has received safety training on the hazards involved (Refer to the latest edition of NFPA 70E for additional safety requirements).







Qualified Personnel shall:

- 1) Have read the entire operation manual.
- 2) Be trained and authorized to safely energize, de-energize, ground, lockout and tag circuits and equipment, and clear faults in accordance with established safety practices.
- 3) Be trained in the proper use and care of protective equipment such as safety shoes, rubber gloves, hard hats, safety glasses, face shields, flash clothing, etc., in accordance with established safety practices.
- 4) Be trained in rendering first aid.
- 5) Be knowledgeable of the DC backup supply system and the required handling and maintenance precautions.

For further information on workplace safety visit www.osha.gov.

 WARNING	
	<p>Misuse of equipment could result in injury and equipment damage.</p> <p>In no event will Toshiba Corporation be responsible or liable for either indirect or consequential damage or injury that may result from the misuse of this equipment.</p>

8 Installation

 WARNING	
	<p>Keep the SPECIFIED CLEARANCE around the UPS.</p> <p>Inadequate space around the UPS makes it difficult to perform maintenance/inspections, lead to insufficient ventilation, and/or will cause malfunctions.</p> <p><i>See Figure 10.1 - UPS Clearance</i></p>
	<p>DO NOT tilt the UPS more than 10° from upright position.</p> <p>Tilting the UPS more than 10° may cause crushing, trapping or other personal injuries.</p>
	<p>Install anchor bolts to secure the UPS to the installation floor.</p> <p>The UPS may fall during an earthquake if the anchor bolts are not installed and secured.</p>
	<p>DO NOT transport, move, store, or place the UPS on its side.</p> <p>Forces due to heavy components inside may damage the UPS.</p>
	<p>DO NOT allow the UPS to suffer shock or impact when unpacking.</p> <p>Tools used to remove packaging materials may cause damage to the UPS.</p>
	<p>DO NOT push or pull on the sides of the packaging, or the UPS to move it. Always use a crane, forklift, or pallet jack for transporting and positioning the UPS.</p> <p>Pushing/pulling on the sides of the unit to move it may result in damage to the UPS. See Figure 4.1 Exterior Handling label.</p>

8.1 Unpacking

Unpack the UPS indoors on a paved floor. The UPS should be as close as possible to its final storage location. Allow enough space for forklift operations to unpack the UPS crate. Then remove the crate.

Points to observe

- Retain all small articles during unpacking and installation.
- Make sure that exterior paint is not scratched and that the UPS cabinet is not damaged.
- DO NOT damage the UPS when using tools to remove packaging materials.
- If provided, DO NOT remove the plastic sheet cover, until installation.
- Do not remove the fan covers until UPS start up. The fan covers should be removed by factory authorized personnel. Packing materials should be disposed by the appropriate means.
- Immediately report any abnormalities to Toshiba Customer Support Center or an authorized representative.

8.2 UPS Clearance

Maintain the indicated clearance during installation. See Figure 8.1. Ensure that the front and top air vents are NOT blocked.

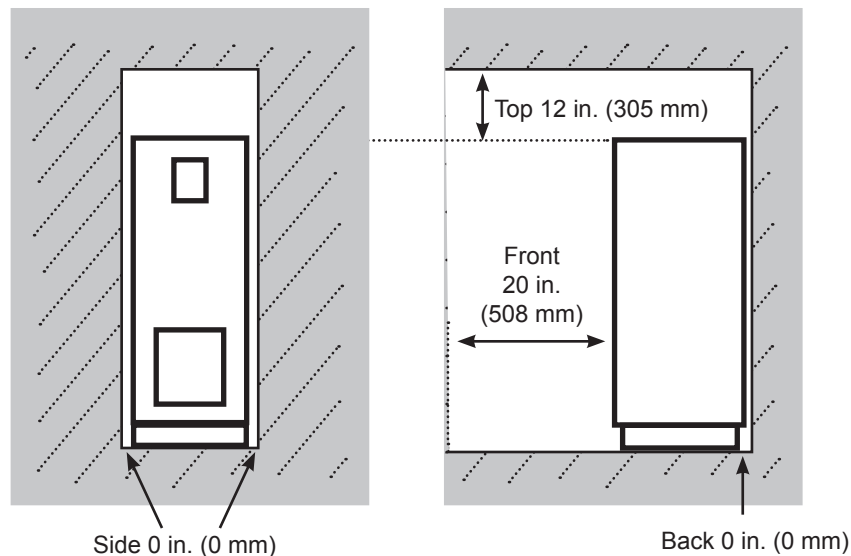

FIGURE 8.1 - UPS CLEARANCE

8.3 Anchor Bolts

Install the anchor bolts to secure the UPS on the floor. See Figure 8.2 for anchor bolt installation detail. Use 5/8" (16 mm) diameter anchor bolts. There are 0.63" (16 mm) diameter holes provided in the UPS base. See Figure 8.3 for the hole locations and dimensions for the specified UPS models.

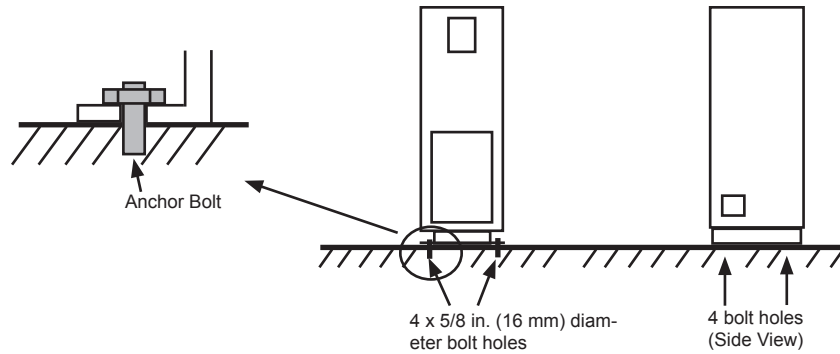

FIGURE 8.2 ANCHOR BOLT INSTALLATION DETAIL

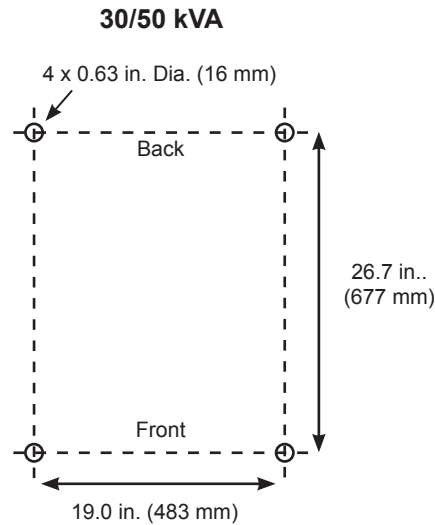

FIGURE 8.3 HOLE LOCATIONS/DIMENSIONS ON BOTTOM OF UPS

8.4 Power Cable Knockout Plates

A cable knockout plates is provided at the top and bottom of the 4300. They are located opposite each other at the front of the cabinet. The dimensions of the openings and their locations are shown below.

Control wiring conduit should be landed on the left side of the conduit landing plate, and power cabling conduit should be landed on the right side of the conduit landing plate.

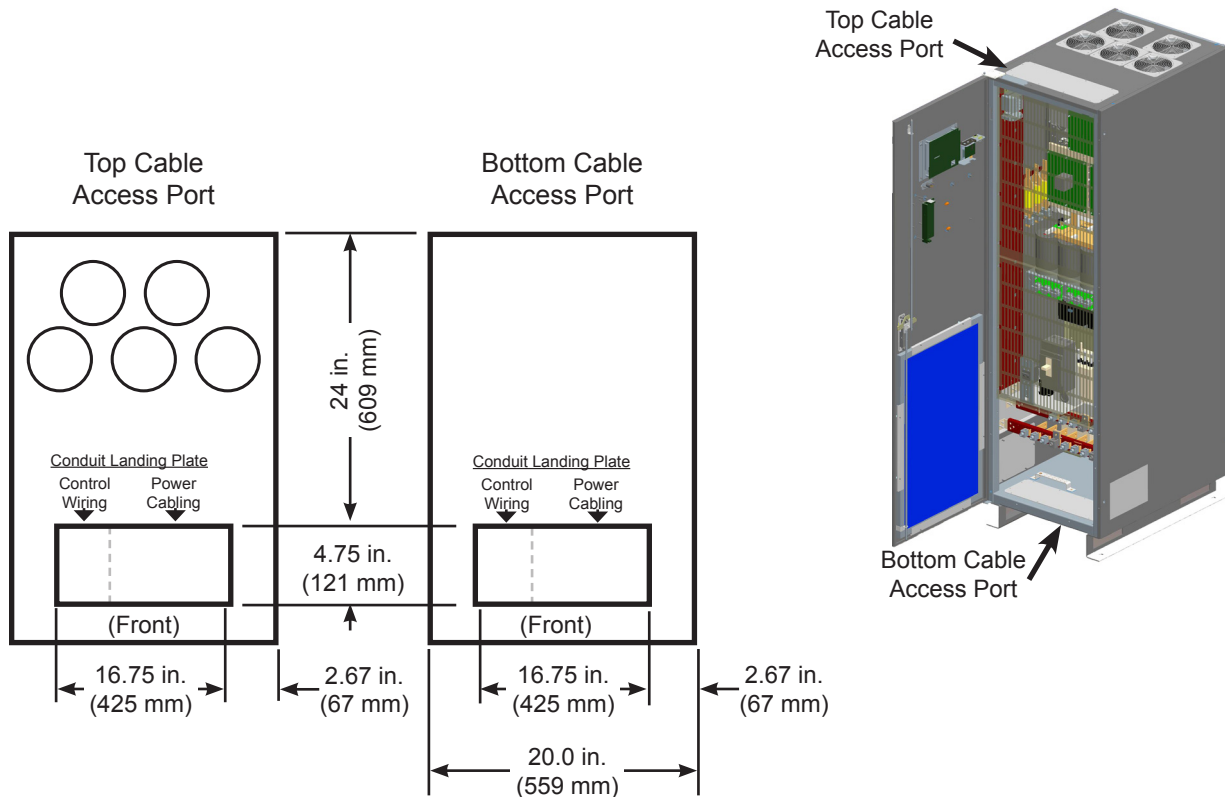

FIGURE 8.4 - TOP AND BOTTOM CABLE KNOCKOUT PLATES (LOOKING DOWN)

8.5 UPS Parts Identification

The following table identifies the major components of the UPS.

TABLE 8.1 UPS COMPONENT LOCATION AND IDENTIFICATION

No.	Description
1	Front Panel Display
2	Locking Door Latch with optional Lockout/Tagout Hasp
3	Upper Deadfront
4	Middle Deadfront
5	Lower Deadfront
6	MCCB - Primary Input Circuit Breaker
7	<i>(Optional)</i> Secondary Input Circuit Breaker
8	<i>(Optional)</i> Air filter

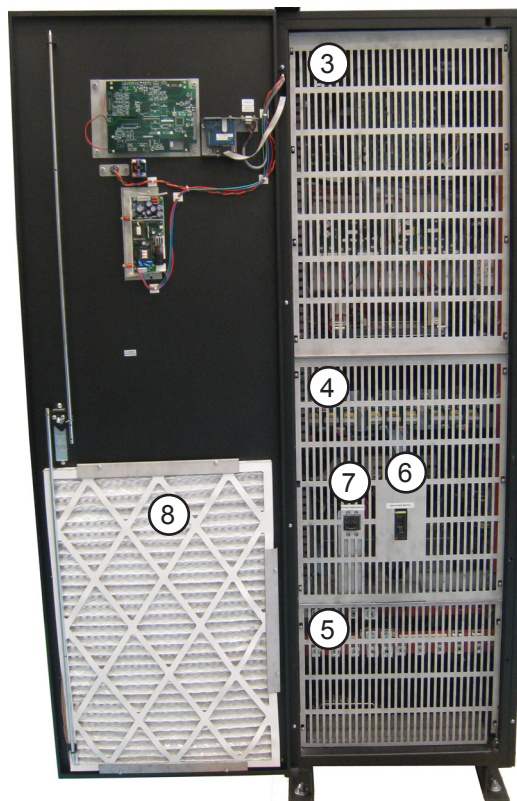
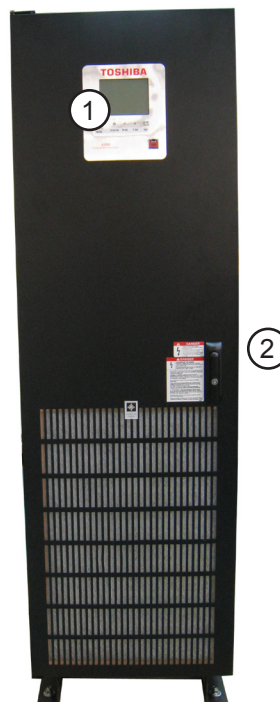

No.	Description
9	PCB 9 - Display Control Board
10	RemotEye Control Board - PCB-9B
11	PCB 4 - Charger Board
12	PCB 1 - Control Board
13	PCB 5 - Thyristor Board
14	DC Fuse
15	PCB 2 - Converter Board
16	PCB 3 - Inverter Board
17	AC Output Fuses
18	AC Input fuses
19	DC Bus Capacitor Bank
20	DC Power supply for PCB-9A (Display Control Board)
21	Primary Input Contactor
22	<i>(Optional)</i> Secondary Input Contactor
23	Output Contactor
24	TB1 with Primary Input, Output, and Backup DC Supply Box Lugs
25	<i>(Optional)</i> TB2 with Secondary Input Power Box Lugs
26	TB3 - (Side-Wall Mounted) Terminals for Battery Cabinet Breaker Shunt Trip and Aux.
27	Shunt Trip DC Power Supply
28	Ground Bus
29	Bottom Cable Access Port

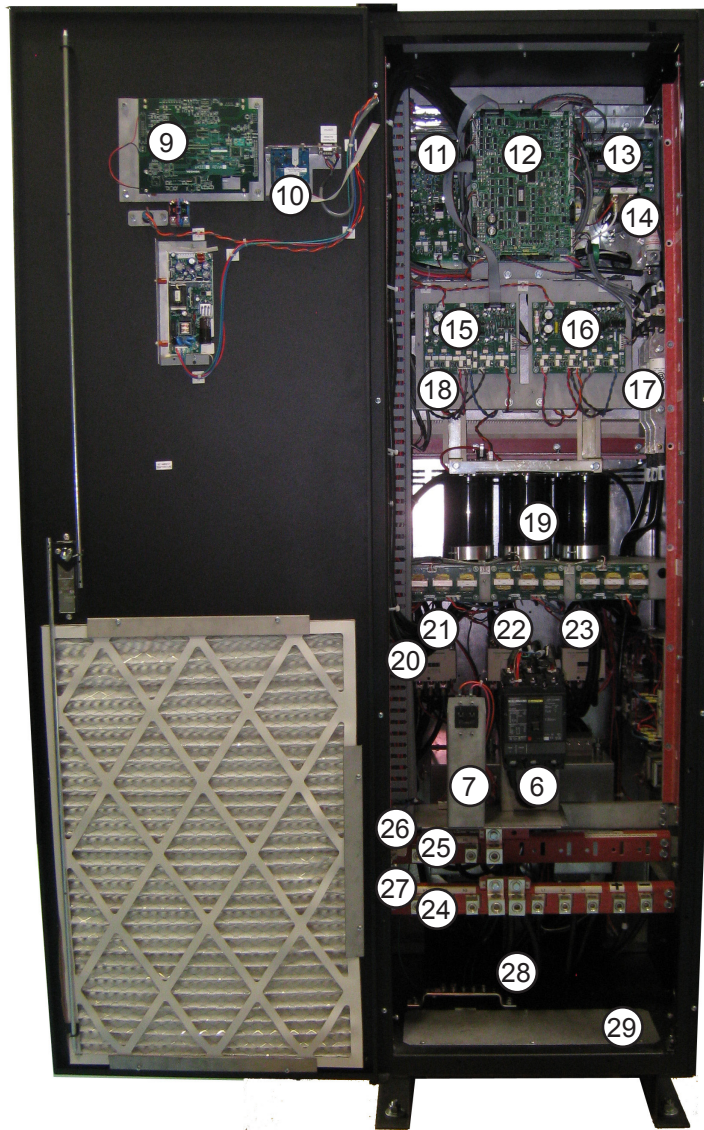

9 UPS Wiring

9.1 One-Line Diagram

Note: Always consult your local and NEC electrical codes for wiring, cabling, and circuit protection device requirements.

Figure 9.1 shows the external wiring of the 4300 UPS with a single input.

Figure 9.2 shows the external wiring needed for the 4300 UPS with the optional dual input.

Figure 9.3 shows the cabling for the 4300 UPS with the optional line-up and match transformer, MBS (Maintenance Bypass Switch), and Battery Cabinet.

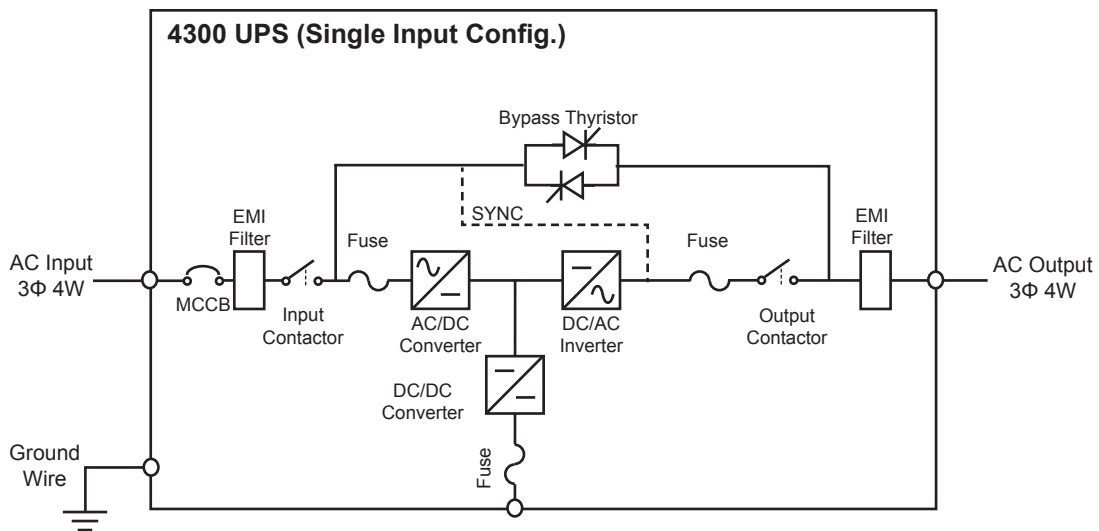

FIGURE 9.1 - 4300 SINGLE INPUT ONE-LINE DIAGRAM

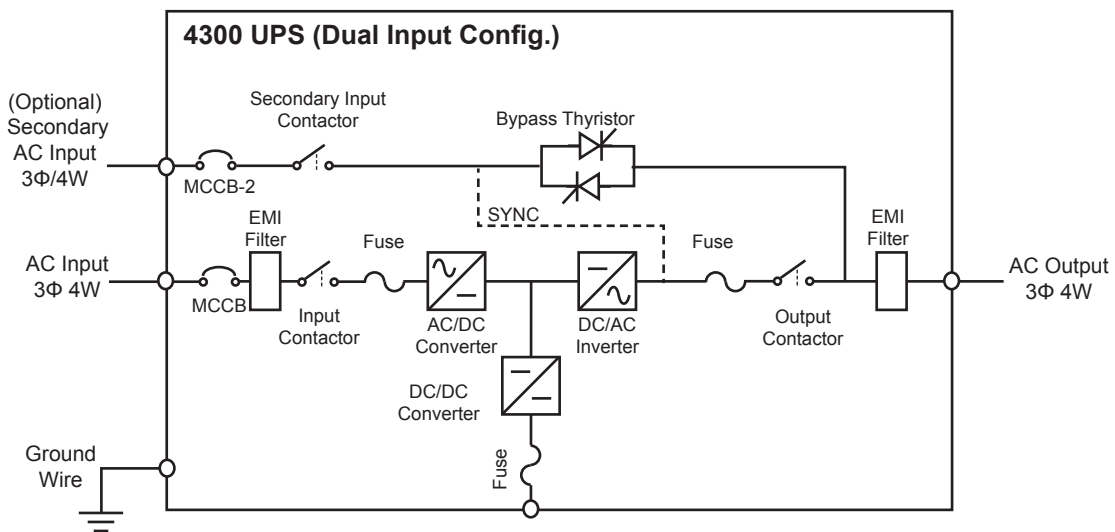

FIGURE 9.2 - 4300 DUAL INPUT ONE-LINE DIAGRAM

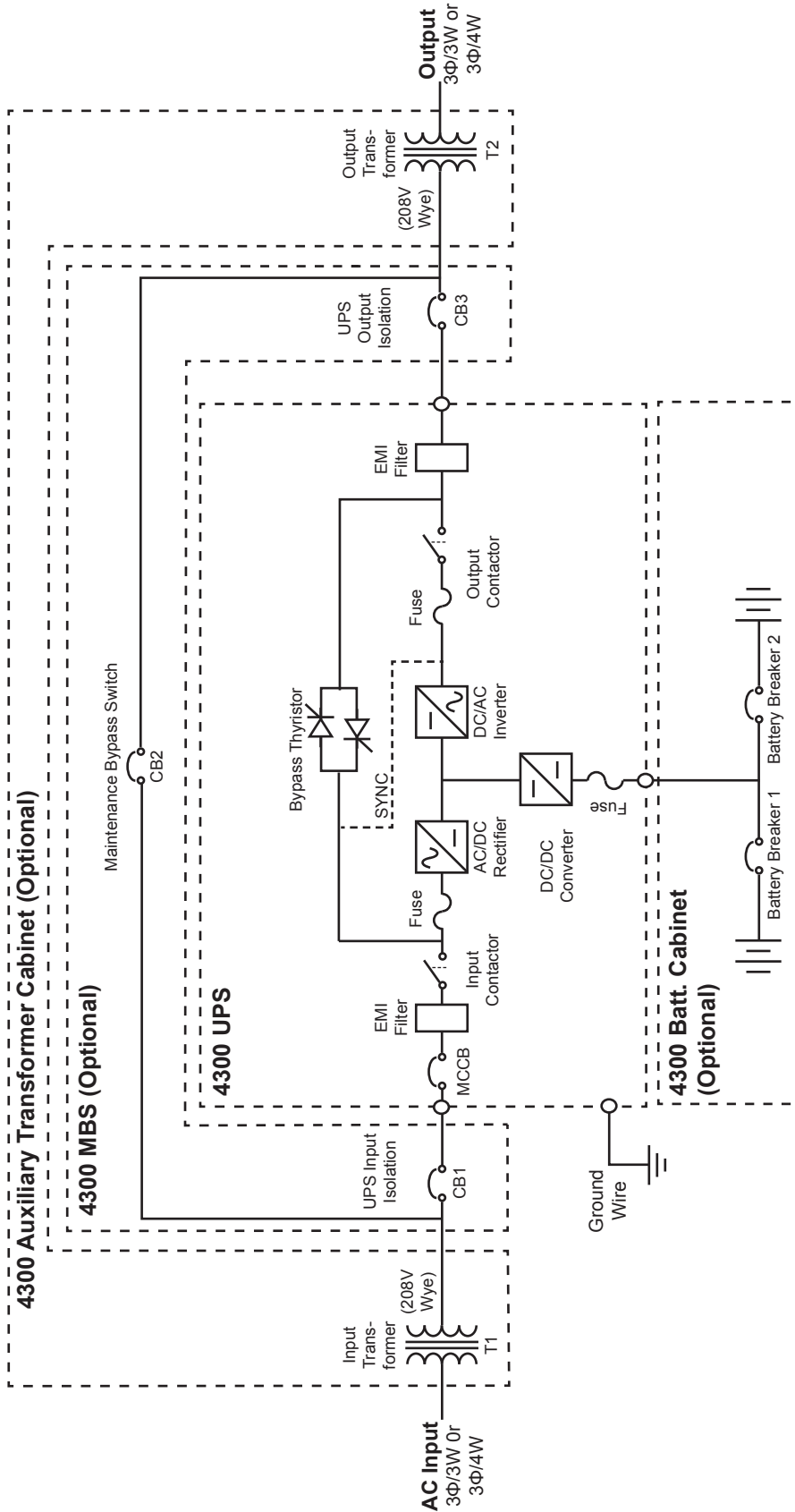

FIGURE 9.3 - ONE LINE DIAGRAM OF 4300 UPS WITH OPTIONAL MATCHING 4300 MBS, 4300 BATTERY CABINET, AND 4300 TRANSFORMER CABINET

9.2 Multiple Battery Cabinets

No more than two Toshiba 4300 Battery Cabinets may be connected in parallel to the 4300.

DC Backup Source cabinets that are not line up and match may be combined to extend the UPS backup runtime. Typically these cabinets must be connected with either a bus structure or to a single point connection outside the UPS. Contact the factory if using more than one DC Source Backup cabinet.

9.3 30/50 kVA Terminal Blocks and Power Cables

Note: Always consult your site specific, local, state, and NEC electrical codes for wiring, cabling, and circuit protection device requirements.

The terminal blocks for the 30/50 kVA UPS are shown in Figure 9.4.

Use only copper wires for external cables.

TABLE 9.1 RECOMMENDED CABLE SIZE & TIGHTENING TORQUE FOR UPS

Block Number	Cable Size (Min-Max) 75 °C Copper Wire in Conduit			Tightening Torque ²
	Terminal Lug Capacity	30 kVA	50 kVA	
AC Input U, V, W	#6 AWG – 250 kcmil	1/0 AWG	4/0 AWG	275 in.-lb. (31 N•m)
AC Input Neutral ²	#6 AWG – 350 kcmil	250 kcmil	350 kcmil	375 in.-lb. (42 N•m)
AC Output U, V, W	#6 AWG – 250 kcmil	1/0 AWG	4/0 AWG	275 in.-lb. (31 N•m)
AC Output Neutral ²	#6 AWG – 350 kcmil	250 kcmil	350 kcmil	375 in.-lb. (42 N•m)
TB2: AC Input U, V, W	#6 AWG – 250 kcmil	1/0 AWG	4/0 AWG	275 in.-lb. (31 N•m)
TB2: AC Input Neutral ²	#6 AWG – 350 kcmil	250 kcmil	350 kcmil	375 in.-lb. (42 N•m)
Battery Terminals +/- ¹	#6 AWG – 250 kcmil	1/0 AWG	4/0 AWG	275 in.-lb. (31 N•m)

¹ One battery string. (Consult factory if using more than one battery string.)

² Size neutral cable appropriate to actual load type: balanced, unbalanced, non-linear.

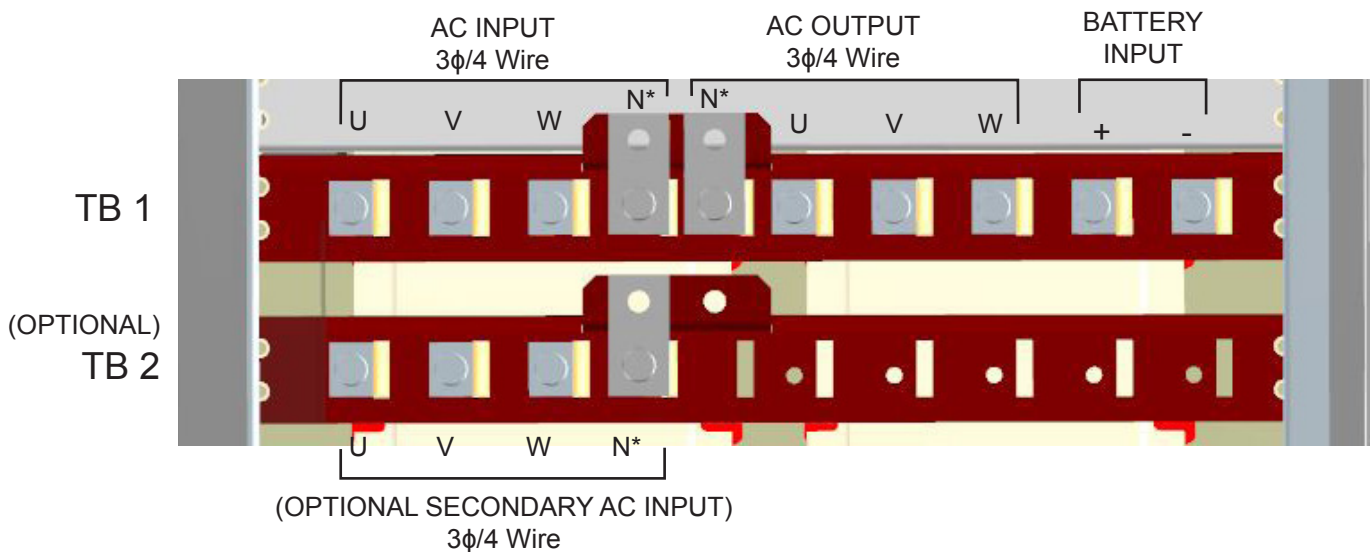

* - Neutral Terminal is AC INPUT 3φ/4 Wire

FIGURE 9.4 - TERMINAL BLOCKS FOR 30/50 KVA UPS

9.4 TB3 - Control Wiring

TB3 provides terminals for connecting the UPS to external control functions. TB3 is located behind the dead-front at the front of the left sidewall next to TB1. The function of each of the 4 terminal pairs is given below.

To connect the UPS 24V power to the battery cabinet shunt trip:

1. Thread the wire harness with the locking connector cap labeled CNEPOB through the cable access port into the UPS
2. Plug it into the UPS locking cable plug labeled CNEPOA, located adjacent to TB3.

TABLE 9.2 TB3 TERMINAL FUNCTIONS

TB3 Terminals	Status* (NO - Normally Open) (NC - Normally Closed)	Function
1 & 2	NO*	Bypass Status - Bypass / Gnd (Switch is closed when UPS is in Bypass mode)
3 & 4	NO*	EPO Status (Switch is closed when UPS is shut down)
5 & 6	NO*	Remote EPO (Closing external switch will shut down the UPS)
7 & 8	Default: NC* (Configurable NO or NC from Display)	Battery Breaker Open/Battery Overheat Sense (Batt Cab CB Aux Switch)

* Switch may be either momentary or latched.

TABLE 9.3 TB3 TERMINAL FASTENING TORQUE

TB3 Terminals	Wire Size	Fastener Torque
1 thru 8	14 – 16 AWG	8 in-lb (0.9 N·m)

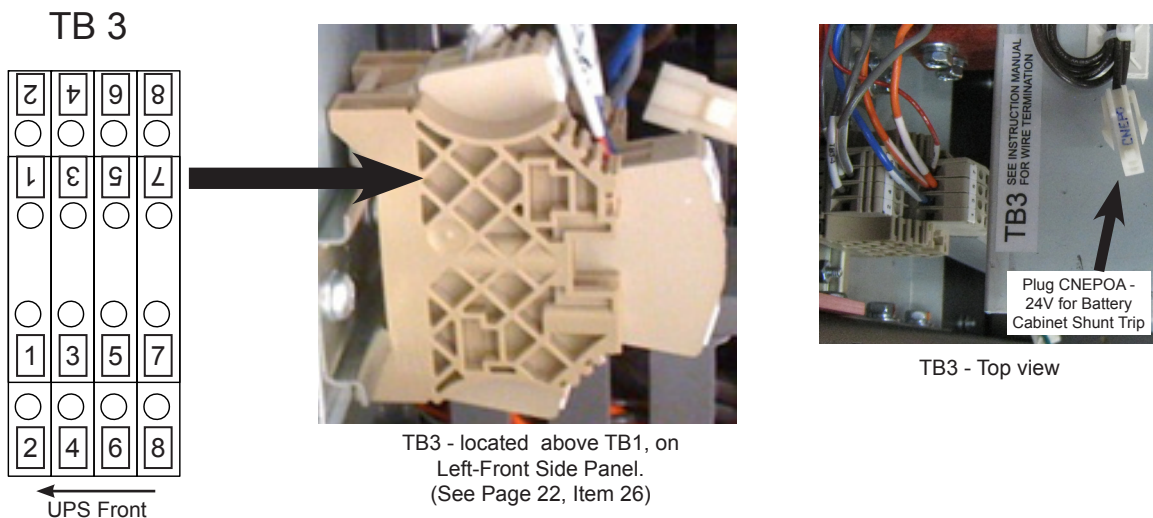

FIGURE 9.5 - TB3 LAYOUT AND LOCATION

9.5 External Breakers

The UPS is not equipped with isolation circuit breakers. Qualified personnel should provide the external breakers for the AC input/output, bypass input and DC input.

See Figure 11.1 – External Wiring Diagram, for the circuit position of the breakers.

Table 11.7 shows the minimum external breaker rating for each UPS. The bypass, input and output require 3-pole breakers.

TABLE 9.4 UPS MINIMUM DEVICE RATINGS

CAPACITY	RATED OUTPUT	INPUT BREAKER RATING	OUTPUT/BYPASS BREAKER RATING	DC INPUT BREAKER RATING
				BATTERY
30 kVA	208/120 V	208 V – 125 A	208 V – 110 A	400 VDC – 150 A
50 kVA	208/120 V	208 V – 200 A	208 V – 175 A	400 VDC – 250 A

9.6 Grounding Wire

 **WARNING**



Be sure to ground the UPS as specified.

Using the UPS without a proper ground will deteriorate the insulation, cause leakage of currents and electric shock. The resistance to ground should be less than or equal to 10 ohms.

The earth grounding bus is located inside, at the bottom-front of the unit. See Section 8.5 - Parts identification.

Use a AWG 2 (or 38 mm²) or larger cable for the grounding wire. Run the grounding wire through either the top, bottom, or side access plates. t

- One ea. 5/16"-18 threaded hole for a 5/16" bolt.
- Twelve ea. ASME 10-32 threaded holes for either 10-32 or M5 bolts.

Attached the appropriate crimp terminal on the ground wires and fasten the ground wire to the ground bus using the appropriate fastener.

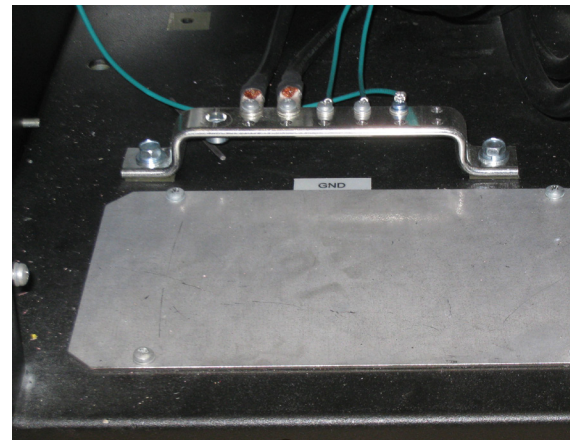

FIGURE 9.6- UPS GROUND BUS

10 Communication Interfaces

10.1 Remote Contacts

The remote contacts interface is provided as a set of solid state switching devices. The switches are available through a DB9 male connector on the door of the UPS. The following chart shows the pin assignment for each signal.

MAXIMUM CURRENT CARRYING CAPACITY OF THE SWITCH

Voltage	Current
30 Vdc peak	70 mA peak
30 V rms (42 Vac peak)	50 mA rms (70 mA peak)

DB9 MALE CONNECTOR OUTLINE (FACING CONNECTOR)

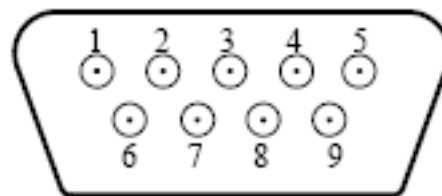

NOTE: Pin switches are shown in their inactive states. For example, if battery voltage is low, pin 7 will be connected to pin 5. Pin number 3 is not used.

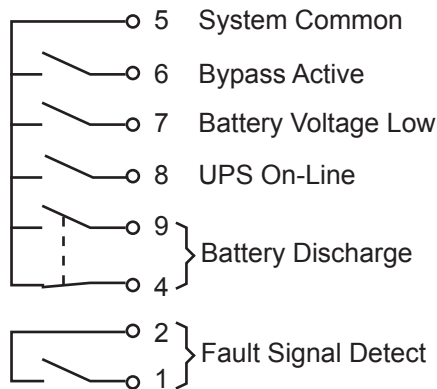

TABLE 10.1 - COMMUNICATION INTERFACE

10.2 RS-232C

An RS-232C port is provided for use by **authorized service personnel ONLY**. The port is provided using a DB9 female connector located to on the inside of the UPS door, just to the right of the Display PCB. The pinout of the connector is illustrated below for reference.

NOTE: Use the cross cable provided by Toshiba to avoid potential communications problems.

RS-232C CONNECTOR PIN ASSIGNMENT

Pin	I/O	Symbol	Description
1	This pin is not used		
2	Input	RXD	Receive data
3	Output	TXD	Transmit data
4	Output	DTR	Data Terminal Ready
5	-	SG	Signal ground
6	Input	DSR	Data Set Ready
7	Output	RTS	Request to Send
8	Input	CTS	Clear to Send
9	This pin is not used		

**DB9 FEMALE CONNECTOR OUTLINE
(FACING CONNECTOR)**

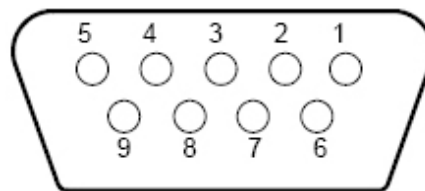

TABLE 10.2 - RS-232C INTERFACE

10.3 RemotEye Network Card

The RemotEye is an optional network card for the Toshiba UPS. This card is located on the back side of the UPS door next to DB9. The card provides a network, or LAN-based communication interface for the UPS. When installed, the UPS can be managed remotely using the common SNMP and HTTP web-based network protocols. The following diagram shows the flow of the Network Management Station.

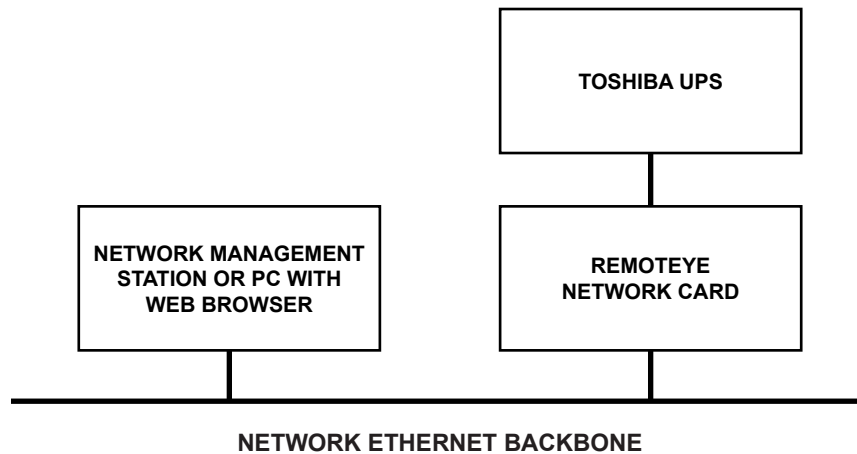

FIGURE 10.3 - NETWORK INTERFACE

10.4 Optional Kickplate Installation

See Appendix B - Optional Kickplate Installation instructions

11 Specifications

11.1 Specification Table

4300 Specifications		
Model Number	4310F3F300	4310F3F500
INPUT		
Rated Output Capacity	30 kVA / 27 kW	50 kVA / 45 kW
Rated Voltage	208/120 VAC (+15% to -20%) (Intermittently to -30% at 70% load ⁴)	
Nominal Input Current	82	138
Frequency	50 ±5 Hz, 60 ±5 Hz (Can be used for frequency converter)	
Topology	True On-Line double Conversion all-IGBT PWM with Active Input Power Factor corrections	
Primary Input Configuration	3 Phase; 4 Wire + GND	
Optional Secondary Input	3 Phase; 4 Wire + GND	
Input kVA	55 kVA (60 kVA Charging)	
Power Factor	> 0.99 PF Lagging	
Walk-in Function	From 20% to 100% over 5 seconds	
Inrush Current	Less than 8X rated current under synchronous operation	
Current Limit	115% Max current	
Input THD Current	< 3% @ 100% Load	
Battery (DC Link)		
DC Nominal Voltage	288 V	
Float Charge	324 VDC (+/- 2%)	
Ripple Voltage	0.5% rms	
Charging Current	431B with Battery Trays - 6A/ 431B with HX205 Batteries - 10 A	
DC-AC Efficiency	91.4%	
OUTPUT		
Rated Voltage	208/120 V	
Rated Current	83A	139A
Rated Power Factor (PF)	0.9 PF	
Loads Supported (PF)	0.4 Lagging to 0.4 Leading PF	
Output Cables Required	3 Phase; 4 Wire + GND	
Voltage Regulation (phase-phase)	+/- 2% (0 – 100% balanced load) +/- 3% (0 – 100% unbalanced load)	
Voltage Adjustment Range	+/- 5 V from touchscreen	
Phase Displacement	+/- 2° (0 – 100% balanced load) +/- 4° (0 – 100% unbalanced load)	
Rated Frequency	50 / 60 Hz	
Frequency Regulation	+/- 0.1% in free running mode	
Frequency Synchronization	+/- 0.5/1.0/1.5/ Hz (+/- 1 Hz std.) Switch selectable by technician	

4300 Specifications		
Model Number	4310F3F300	4310F3F500
Frequency Slew Rate	1 Hz to 3 Hz (in 0.5 Hz steps)	
Voltage Transients (Recovery time : 50 ms)	+/- 5% (100% step load change) +/- 3% (loss or return of input voltage) +/- 8% (transfer from bypass to inverter)	
Inverter Overload Capacity	125% for 90 sec.; 150% for 30 sec.	
Crest Factor	3.6	2.8
Neutral Line Conductor	Sized for 200% of line rating	
Voltage THD	1.5% max.	
Inrush Current Protection	Automatic transfer to bypass, then retransfer to inverter	
System		
Efficiency (Typical)	See Section 11.2	
Thermal Load	See Section 11.3	
Short Circuit Interrupt Rating (kAIC)	35 kAIC	
Dimensions (WxDxH)	22.1 in. x 31.6 in. x 73.7 in. (561 mm x 802 mm x 1872 mm)	
Weight	788 lb. (357 kg)	867 lb. (393 kg)
Audible Noise	~65 dBA @ 1 meter from front of unit	
Operating Temperature	32 – 104 °F (0 – 40 °C)	
Operating Humidity	5% – 95% RH (non-condensing)	
Altitude	to 6600 ft. (2000 m) without derating ²	
Color	O'Brien Black (Textured)	
Features	Standard: RS-232 for remote monitoring Optional: Secondary input terminals RemotEye internet monitoring, Line-up and match Battery Cabinet, Transformer Cabinet, Maintenance Bypass Cabinet	
Standards	UL 1778, cUL, NEC, ISO9001, ISO14001, ANSI C62.41 (IEEE 587), NEMA PE1-1993	
Warranty	See Toshiba Warranty Policy for Full Details	
Operation Diagnosis		
Input OV Protection	Standard	
Internal Temperature	UPS gives indication of internal temperature, alarm when high temp	
Event Data Storage	16 – Operation, 16 – Backup, 16 - Warnings, 16 – Faults, 16 - Test, 16 - System	
Applications		
Switches	Generator compatible	
Bypass Switch		
Bypass Disable	Static switch < ¼ cycle (50 Hz – 5 ms/60 Hz – 4.16 ms)	
Automatic Retransfer	Factory or authorized service center selectable only	
Other		
Real Time Clock	Real Time Clock with backup Supercap.	

4300 Specifications		
Model Number	4310F3F300	4310F3F500
Schedule Operation	Schedule Bypass/On-Line operation of UPS using optional RemotEye communication software	
Autostart	Automatic UPS Startup when AC is applied - Option can be enabled or disabled at user's discretion	
Remote Bypass/On-Line	Standard – External terminal	
Emergency Power Off	Standard – Terminal contacts only	
LED Display	3 LED's indicating On-Line/Fault, Warning, and A/C Input	
Operator Interface	Interactive Touchscreen	
Buzzer Volume	Standard (Fixed Volume)	
Power Connections	Standard – Hard wire	
RS-232C Interface	Toshiba UPS Communication Protocol 2.0	
Service	7 x 24 Technical Support 1-877-867-8773	

1 - Specified at rated conditions under balanced linear loads.

2 - At 6600 ft. (2000 m) above sea level, output capacity should be derated by 3% (Consult factory for higher elevations).

3 - Prolonged operation at this level requires derating of the maximum Operating Temperature to 90 °F (32 °C).

4 – SHORT TERM operation only at 70% Load (e.g. Brownouts). Operation at this level requires derating the maximum Operating Temperature to 95 °F (35 °C).

11.2 Typical Efficiency vs. Load

EFFICIENCY AT VARIOUS LOADS

UPS % Full Load	Efficiency at Percent Full Load	
	30 kVA*	50 kVA
100%	91.9%	91.1%
75%	93.4%	91.2%
50%	93.2%	90.9%
25%	88.0%	88.8%

* Subject to change without notice.

11.3 Typical Thermal Loss vs. Load

THERMAL LOSS AT VARIOUS LOADS

UPS % Full Load	BTU/hr. Loss at Percent Full Load	
	30 kVA*	50 kVA
100%	8,153	15,019
75%	4,883	11,181
50%	3,336	7695
25%	3,156	4856
0%	2047	3412

* Subject to change without notice.

12 Operator Interface

12.1 Operator Controls

Figure 12.1 shows the functions of the operating buttons on the graphic display panel.

NOTICE

Press the reset button for at least 2 seconds to reset the display.
The display may not respond if the button press is too short.



FIGURE 12.1 – UPS DISPLAY PANEL

12.2 Operator Controls - Light Emitting Diodes (LED)

The following table describes the front panel LED behaviors and the associated meaning.

TABLE 12.1 - LED BEHAVIOR KEY

LED	Behavior	Significance/Meaning
On-Line/ Fault	Green - ON	UPS is in On-Line, Backup, or Battery Test mode.
	Green - OFF	UPS in Bypass or Shutdown mode.
	Red - ON	One or more faults occurred. See <i>Records: Faults</i> for details.
	Red - OFF	No fault occurred.
Warning	Amber - ON	Service Call needed.
	Amber - Flashing	One or more Warnings occurred.
	Amber - OFF	No Warning occurred.
A/C Input	Green - ON	Input or Bypass voltage is within specified range.
	Green - Flashing	Input or Bypass voltage is over specified range.
	Green - OFF	Input or Bypass voltage is under specified range.

NOTE: On-Line/Fault LEDs - Appear Amber if Green and Red flash concurrently.

12.3 Operator Controls

Bypass/On-Line Switch

Switches the UPS between On-Line and Bypass modes.

Display Reset Switch

Allows the display to be rebooted without powering down the UPS. The display can be reset by pressing the Reset Switch with a thin probe, such as a paper clip.

EPO (Emergency Power Off) Function

These units are equipped with a front panel mounted EPO switch.

This safety feature enables quick shutdown of the UPS AC output and battery circuits.

The EPO function is initiated by pressing the switch to the closed “shutdown” position. The effect of using the EPO switch is the same whether the UPS is in the AC Input Mode, Battery Backup Mode, or the Bypass Mode. See ‘EMERGENCY OFF’ screen.

The following figure shows the UPS condition after application of the EPO switch. Use the Start-up Procedure for restarting the unit.

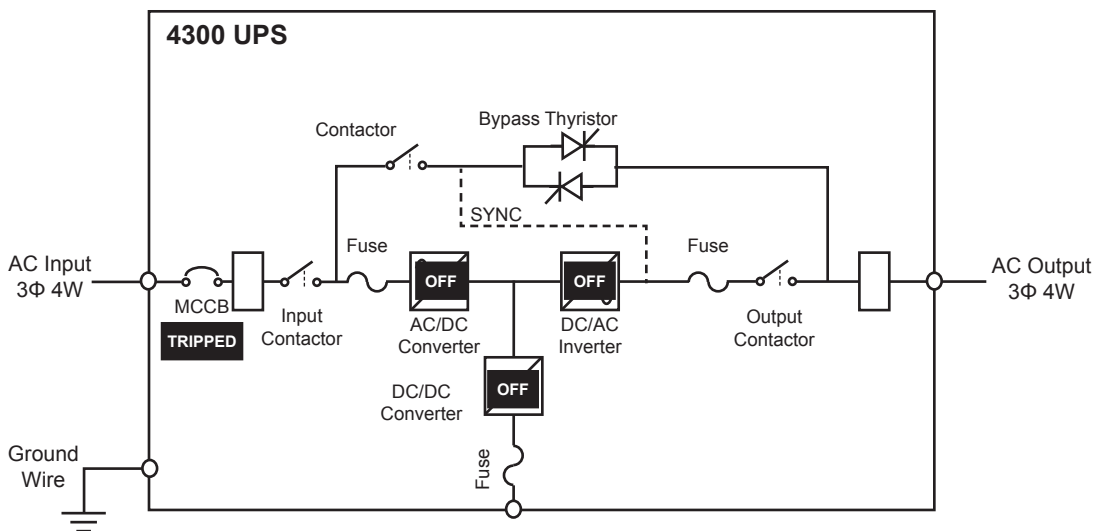
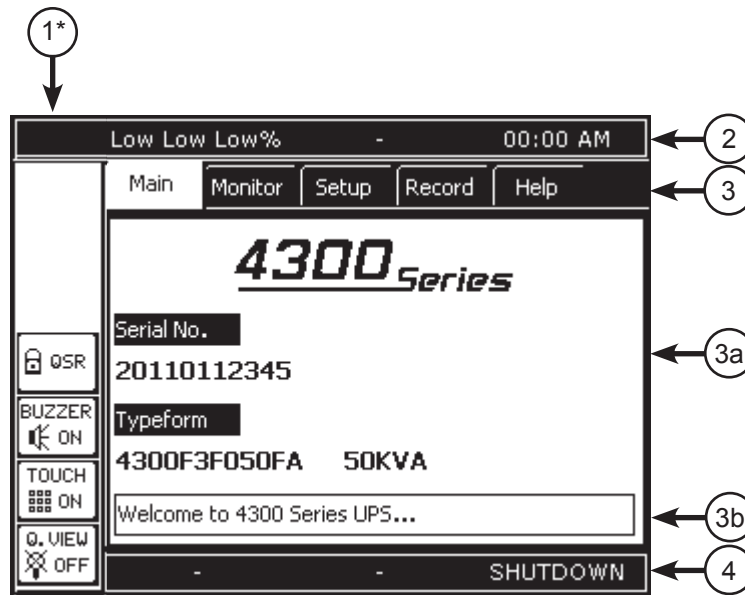

FIGURE 12-2 - EFFECT OF EPO ACTIVATION

12.4 Touch Screen Display

The various components of the touchscreen display are identified in Figure 12-3.



Touchscreen Layout	
No.	Function
1*	Quick Access Toolbar - Interface/Status Switches (push-button icon changes to reflect current status)
2	Header Bar - Displays system load, status, and time.
3	Menu TABS - Top level menu. Touch a Tab to activate the display mode
3a	Data display area
3b	Update - Displays current status and operation hints.
4	Footer Bar - Displays Faults, Warnings, and UPS Operating Mode.

* - Older versions of the display may show the Interface/Status switches at the top of the Quick Access Toolbar.

FIGURE 12.3 – TOUCHSCREEN DISPLAY COMPONENTS (INITIAL MAIN DISPLAY)

12.5 Header Bar

The Header Bar on the graphic display panel displays three system parameters: the System Load, Current Status, and System Time.

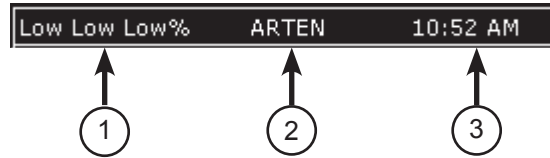

Header Bar Components	
No.	Function
1	System Load - Load per each phase as percent of full load. Low - Less than 10% Load.
2	Current Status - UPS status at the moment. (Status is delayed by a few seconds)
3	System Time - Current time in AM-PM format

FIGURE 12.4 – HEADER BAR DISPLAY COMPONENTS

12.6 Footer Bar

The Footer Bar on the graphic display panel displays three system parameters:

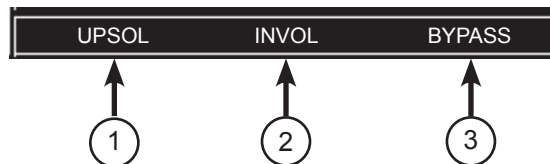

Footer Bar Components	
No.	Function
1	Fault - Displays last fault sensed by UPS. A Fault causes the UPS to switch to bypass and it will not automatically reset.
2	Warning - Displays last warning sensed by UPS. Multiple frequent warnings of the same type may induce a fault condition.
3	UPS Mode - Selected operating mode.

FIGURE 12.5 – FOOTER BAR DISPLAY COMPONENTS

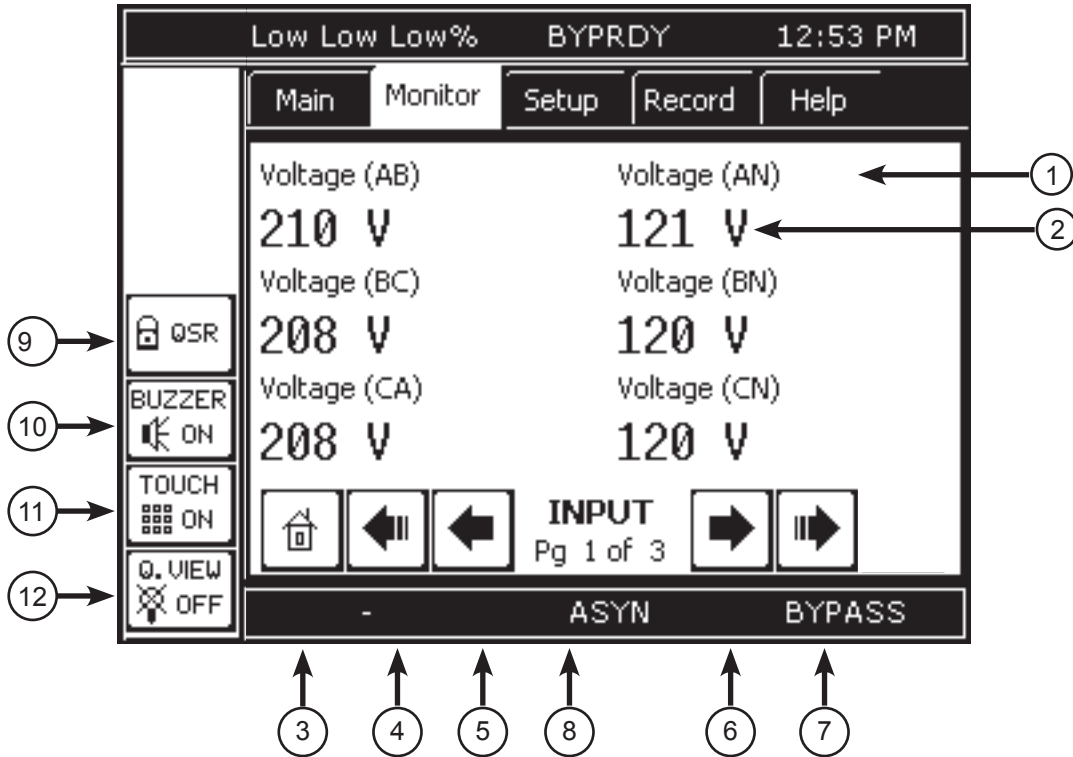







Touch Screen Controls	
No.	Function
Display	
1	Parameter Description
2	Parameter Value
Navigation Bar	
3	Home
4	Go To First Page
5	Go To Previous Page
6	Go To Next Page
7	Go To Last Page
8	Parameter Type (Input, Output, Communication, DC) and Pages of Data.
Quick Access Toolbar	
9	Security Level (USR, ADM)
10	Warning Buzzer Switch/Status (press for ON, press again for OFF)
11	Touchscreen Enable/Disable
12	Quick View Selector (press for Quick View, press again for Normal View)

FIGURE 12.6 - TOUCHSCREEN CONTROLS

12.7 Quick Access Toolbar

The Quick Access Toolbar allows the operator easily perform routine commands. The Quick Access Toolbar buttons and their function are listed below.

TABLE 12.2 - QUICK ACCESS TOOLBAR CONTROLS

Quick Access Toolbar Controls	
No.	Function
	Security/Access Level - Access levels are: USR, ADM
 	Warning Buzzer mute. Press to silence buzzer. Buzzer will sound again at next fault event. (To silence buzzer for all fault events set to "Disable".)
 	Touch Screen ON/OFF button. Press to toggle between ON and OFF. <ul style="list-style-type: none"> • ON enables all touchscreen active areas. • OFF disables all touchscreen areas except the TOUCH button.
 	Quick View On/Off Selector - Press to toggle between Normal view and Quick view. Quick view displays a simultaneous summary of the Input/Output/Bypass/DC Voltages and Currents

12.8 4300 Menu Tree

Below is a menu tree for the 4300 display.

- Quick Access Toolbar buttons allow immediate control of important functions.
- Menu Tabs allow access to varying degrees of detailed information concerning the UPS operation, performance and parameters. The degree of information available is determined by the Security mode, which can be changed pressing the top Quick Access Toolbar button and entering the appropriate password.

(Quick Access Toolbar Buttons)

ADM - Security Mode: USR and ADM

BUZZER ON - Toggles between BUZZER ON, BUZZER OFF

TOUCH ON - Toggles between enabling and disabling the touchscreen.

Q. VIEW ON - Toggles between Quick View and standard view (Q. VIEW OFF)

(Tab Buttons)

(TAB Selection Buttons)

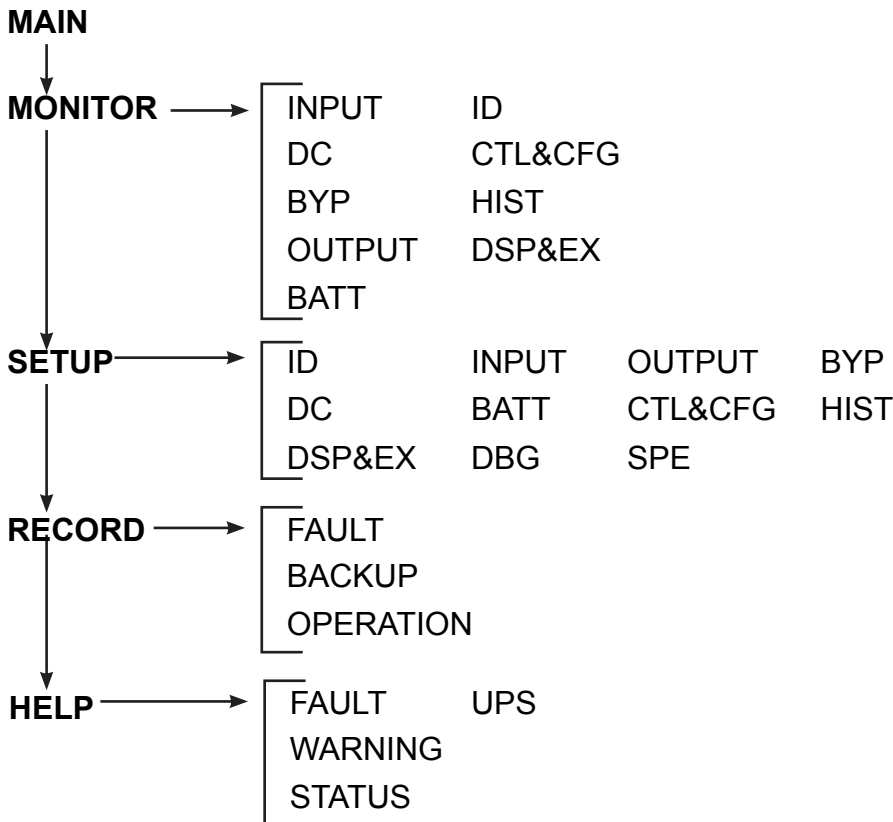

FIGURE 12.7 - MENU TREE

12.9 Toolbar: Security

The UPS initializes in the USR, or lowest security mode. To change the display security level, press the Security button.

The screen displays an alpha/numeric keypad to enter the appropriate password for the desired security level. The UPS ships with a default ADM password of ADMIN.

In the example below, to change the security level from USR to ADM:

1. Press the Security button. The alpha/numeric keypad is displayed.
2. Type in the ADM password "ADMIN" - Press the ABC button once for A, twice rapidly for B, etc.
3. After entering the password, press WRITE.
4. If the password is accepted the display will show "Successful". Press QUIT to return to the Main display, and the Security button will display the ADM security level.
If the password is not accepted, the screen will return to the Main display and the Security button will display the USR level.

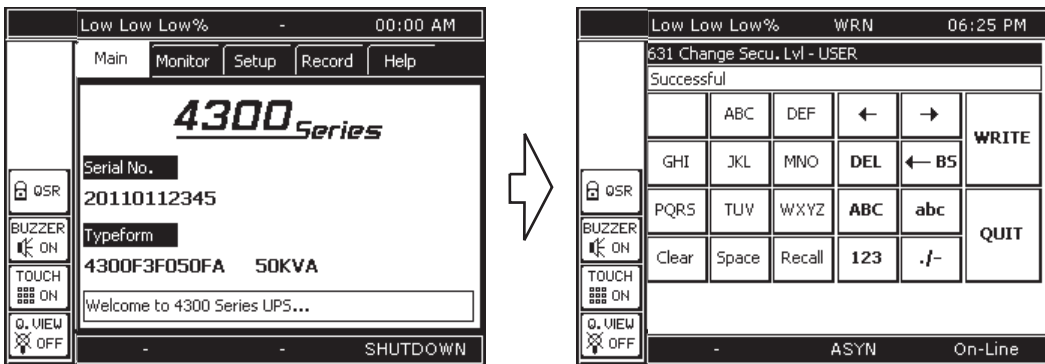

FIGURE 12.8 CHANGING SECURITY LEVEL

12.10 Toolbar: Buzzer ON/OFF

The UPS Buzzer sounds when a fault occurs or when the UPS switched to backup mode. The Toolbar allows the user to turn on/off the buzzer.

The buzzer can also be enabled or disabled through the setup menu. If the Buzzer is disabled through the setup menu, the Toolbar Buzzer button will be disabled.

12.11 Toolbar: Touch ON/OFF

The touchscreen can be turned OFF (locked) by pressing the TOUCH ON/OFF button. With TOUCH OFF, only the TOUCH button is active, the rest of the display will not respond to touch.

12.12 Toolbar: QUICK VIEW ON/OFF

At anytime while using the tabs to view system details, the summary of the UPS Input, Output, and DC Bus can be viewed by pressing the Q. VIEW button (Button will display Q. VIEW ON). The illustration below highlights the critical features of the Quick View display.

Exit Quick View by pressing the Q. VIEW button again. (Button will display Q. VIEW OFF)

TABLE 12.3 - QUICK VIEW DISPLAY

No.	Description
1	Displays Vin, Vout, and Vbyp for all three phases
2	Changes voltage display mode: Press repeatedly to display sequentially the voltage as: Line-to-Line (LL), Line-to-Neutral (LN), and Voltage as a % of rated Voltage (%). The highlighted icon indicates the voltage display mode.
3	Displays output current for all three phases.
4	Changes current display mode: Press repeatedly to display alternately the current in Amps (A), or as a % of rated current (%). The highlighted icon indicates the current display mode.
5	Displays DC Bus voltage, Battery voltage, and Battery discharge current.

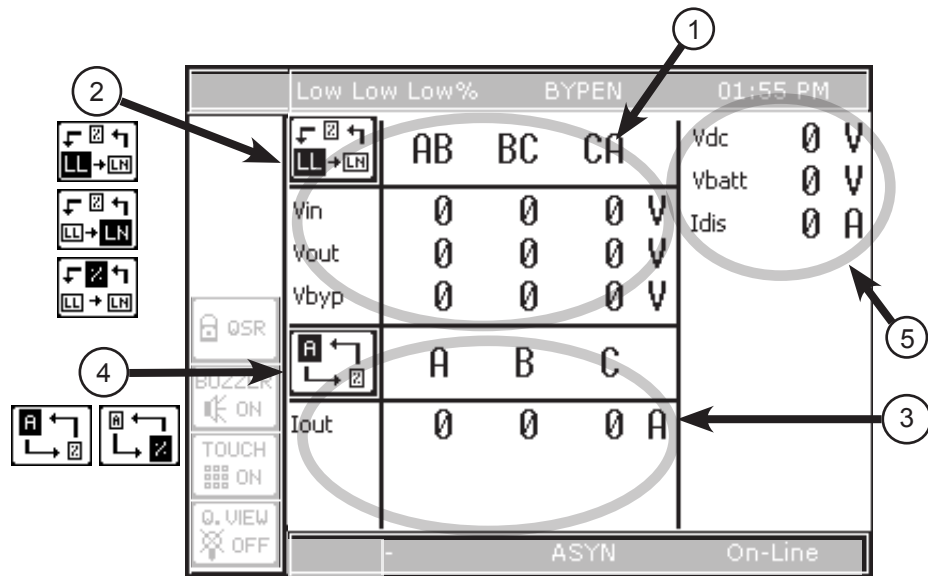

FIGURE 12-9 QUICK VIEW DISPLAY

12.13 Tab: Main

The Main tab displays the UPS Serial Number and Typeform.



Main Tab Components	
No.	Function
1	Serial Number - UPS Serial Number
2	Typeform - UPS typeform
3	Information Bar - Randomly displays status, helpful hints, acronym definitions every two seconds.

FIGURE 12.10 – MAIN TAB COMPONENTS

12.14 Tab: Monitor

The MONITOR tab allows the user to select a specific group of performance parameters to view; Input, Output, Bypass, DC Link, ID, Control and Configuration, History, and Display and External Communications (RemotEye).

The right side of the display is a vertical stack of five buttons: 4 active and 1 reserved for future use.

The middle of the display contains five buttons arranged in a diagram representing the functional model of the UPS. The lines connecting the mimic buttons represent the power flow from input to output. A thin line indicates no current flow, and a thick or bold line indicates current flow. See the Mimic Display current Flow Indicator illustration on the following page.

The figure below illustrates the data displayed when the corresponding button is pressed.

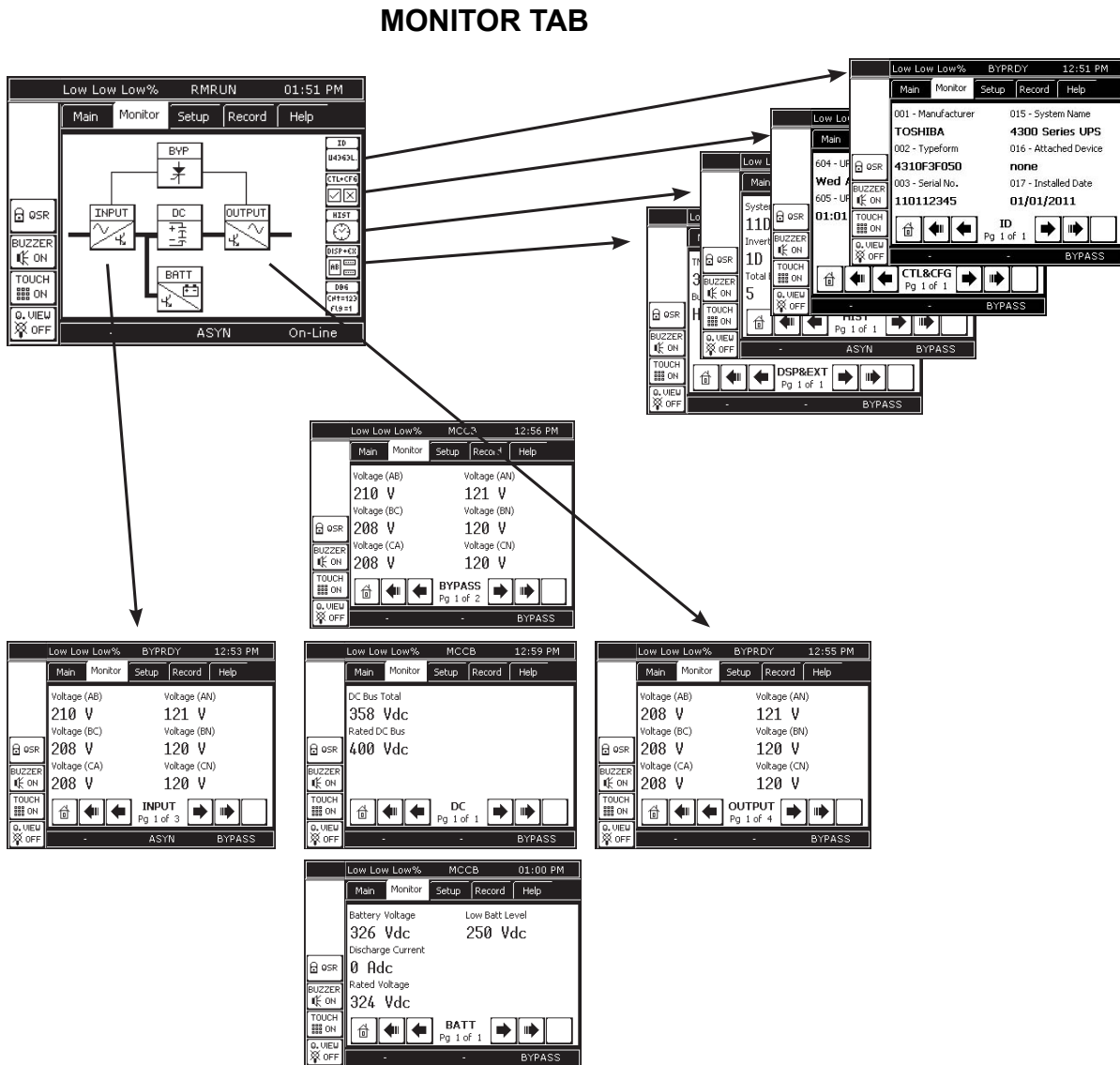

The mimic display indicates the power flow through, or around, the UPS. There are four possible modes the UPS operates in: Off, Bypass, On-Line, and Backup. The figure below illustrates the display for each of these modes.

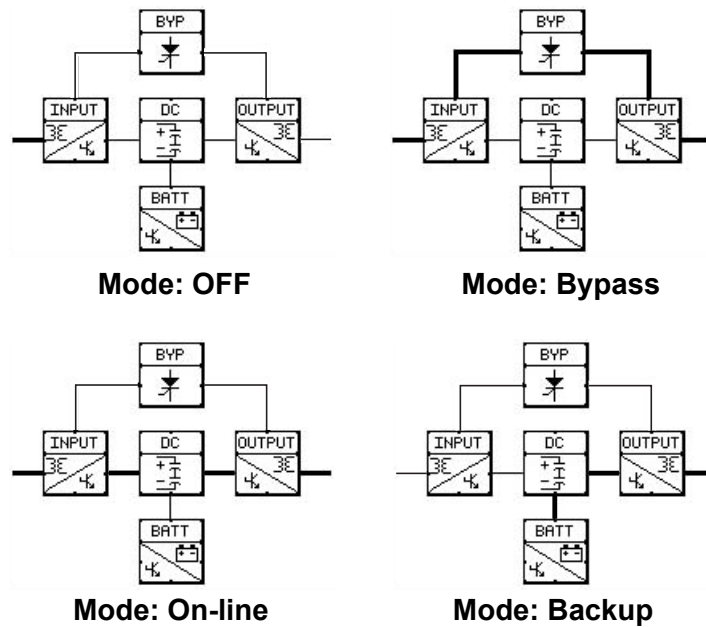
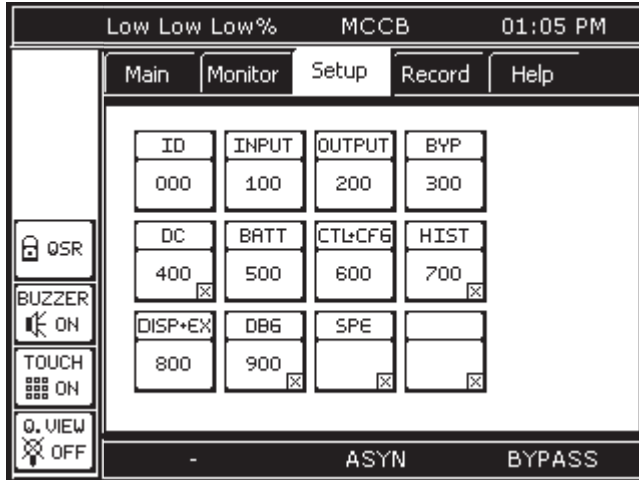

FIGURE 12-12 MIMIC DISPLAY CURRENT FLOW INDICATOR

12.15 Tab: Setup

The SETUP tab allows the user to adjust certain UPS parameters. The setup tab shows 12 buttons. Inactive buttons are indicated with a “x” in the lower right-hand corner of the button. The table below, right, shows a typical SETUP button.



Typical Button	Significance
	No “x” in the lower right corner indicates the button is active. Pressing the button will open a data page displaying the parameters available at the current security level.
	A button that has an “x” in the lower right corner is inactive and cannot be accessed at the current security level.

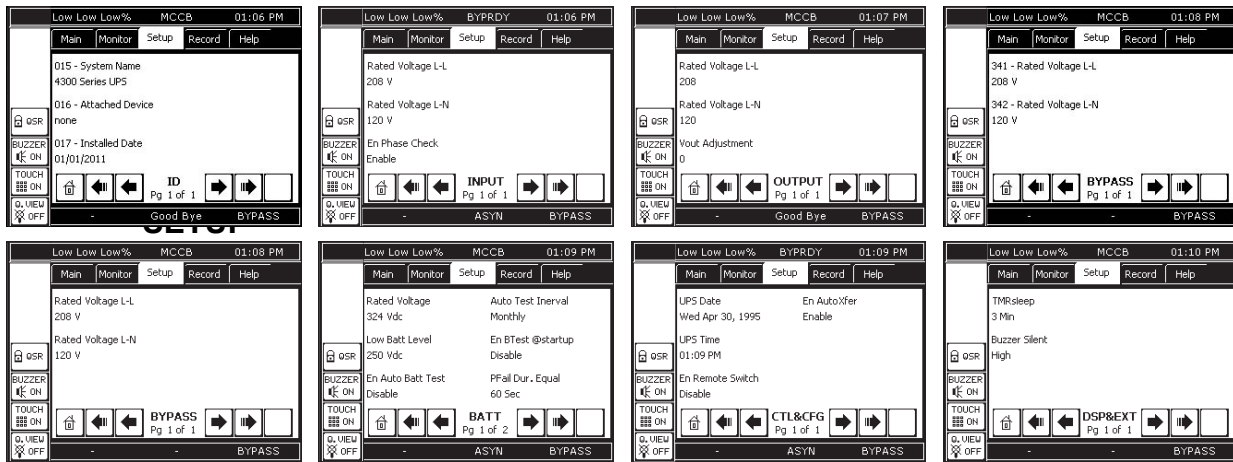

Param. Prefix	Parameter Category
0	UPS Identification, Serial number, Start-up Date, software version
1	Input line-line and line-neutral V/I values, V/I percent of rated value, and frequency
2	Output line-line and line-neutral V/I values, V/I percent of rated value, and frequency
3	Bypass line-line and line-neutral V/I values, V/I percent of rated value, and frequency
4	DC Bus Voltage, DC Under Voltage Level, Startup Voltage Level
5	Battery Voltage/Current, shutdown voltage, battery test enable
6	Control and Configuration - UPS time/date/status, faults, warnings, password management
7	UPS Operation time, Number of Faults, Backup, Operations.
8	Display and Ext Comm. - Disp. S/W version, buzzer status, display calibration values. RemotEye I/P address, data and network status.

FIGURE 12.13 - PARAMETER CATEGORIES

Tab: SETUP (cont.)

Pressing an active button will cause a list of parameters to be displayed (See previous page). Pressing a listed parameter will activate a display appropriate to the parameter selections available. If the parameter cannot be edited at the current security level, the display will not change. If the parameter can be edited or changed, an appropriate keypad will be displayed as shown below. Either a alpha/numeric keypad, a multiple choice, or binary choice display will appear.

After entering data or selecting an options, press WRITE to save the selections, or QUIT to leave the current value unchanged.

Example 1 - Alpha/numeric display.

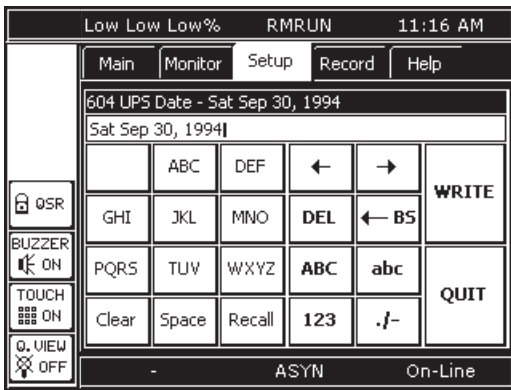

Example 2 - Multiple Choice Display with Default value Marked (*)

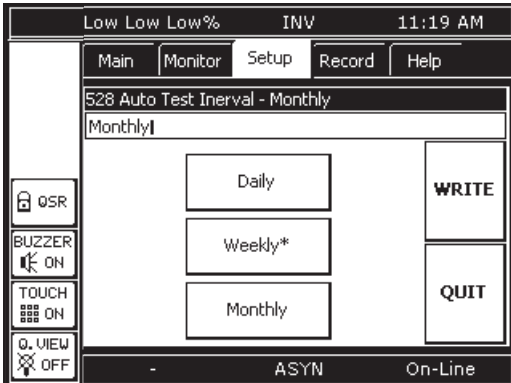
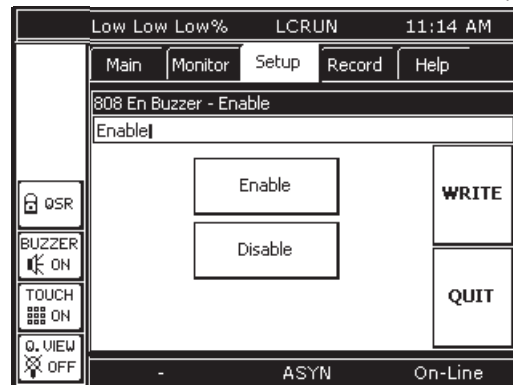

TABLE 12.4 - TOUCHSCREEN KEYPAD IDENTIFICATION

Button	Action
Clear	Delete all characters on input line
Space	(Space bar)
Recall	Restores previous entered value
← →	Move cursor one space left or right
DEL	Delete character to right of cursor
← BS	Back Space - Delete character to left of cursor
ABC	Set Keypad to capital letters (A,B, C...)
abc	Set Keypad to lower case letters (a, b, c...)
123	Set Keypad to numbers (1, 2, 3...)
./-	Set Keypad to write Special Characters (. , - : /)
Write	Write information (Enter) (Pressing Quit without first pressing Write will cause the newly entered data to be lost.)
Quit	Exit keypad.

Example 3 - Binary choice (On/Off, Enable/Disable, Contact A/Contact B)



12.16 Setup: Calibrating the Touchscreen

At anytime while using the tabs to view system details, the touchscreen can be calibrated by executing the built-in calibration routine.

To calibrate the touchscreen:

1. Press the **Setup** Tab.
2. Press the **DISP-EX 800** button
3. Press the entry **Cali** to begin the calibration routine
4. Follow the directions on the display to press the “+” at each location it flashes on the display. To exit the calibration routine press QUIT at any time. See Fig. 2-10 A, B.
5. After the touchscreen has been recalibrated the display will indicate that the calibration routine has passed. Press Quit to return to the main display. See Fig. 2-10 C.

A

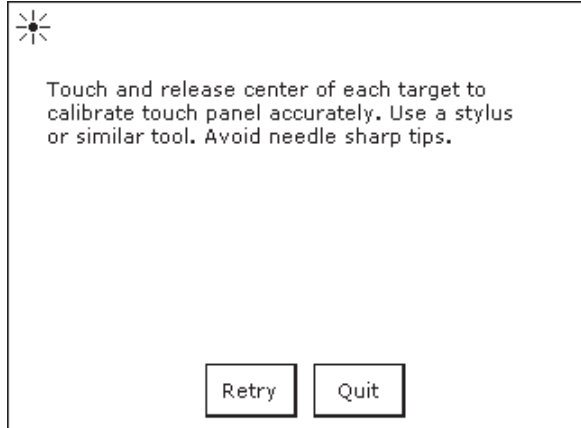

B

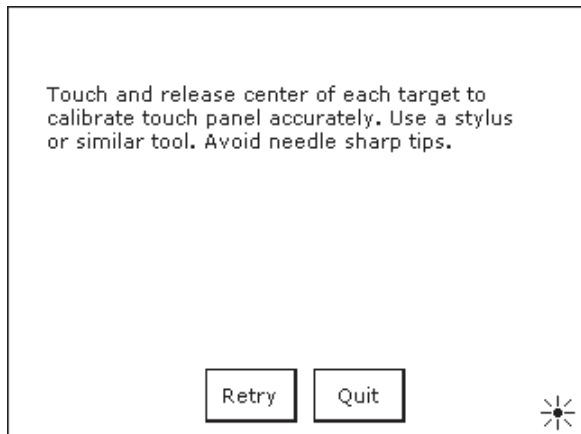

C

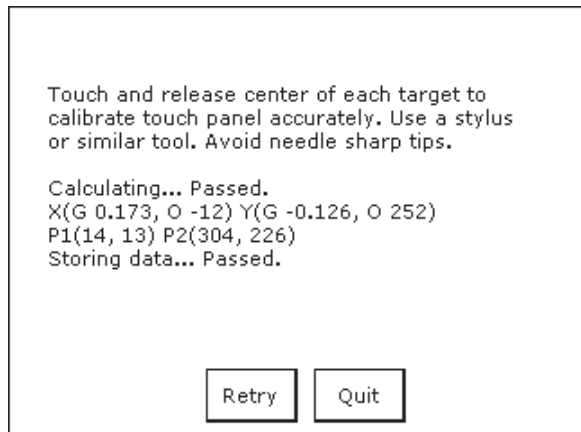

FIGURE 12-14 TOUCHSCREEN DISPLAY CALIBRATION

12.17 Tab: Record

The tab Record offers three types of records: Operation, Backup, and Fault.

Backup Record	Description	Max. Number of Records
Operation	Every change in operating mode is recorded by time, date, and mode.	16 records before overwrite
Backup	Every time the UPS switches to and from backup, the time and date are recorded.	16 records before overwrite
Fault	Every time a fault occurs, the date, time and fault is recorded.	16 records before overwrite

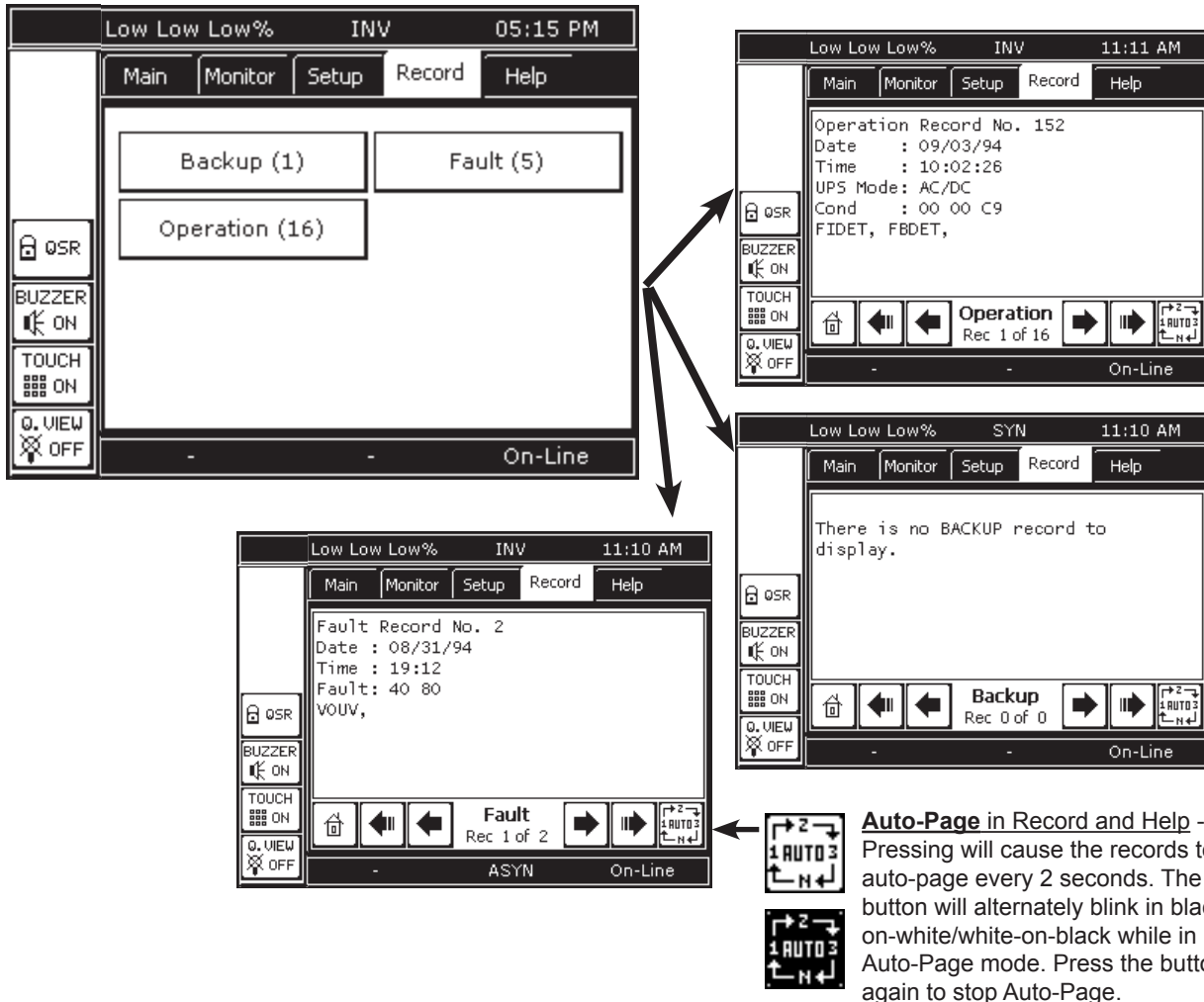

FIGURE 12.15 - RECORDS

12.18 Tab: Help

This on-line help provides ready definitions of the Acronyms displayed on the touchscreen and their definitions. Each acronym and accompanying definition is displayed on a single page.



The navigation bar has an additional button in Record and Help called Auto-Page. Pressing Auto-Page will cause the records to auto-page every 2 seconds. The button will alternately blink in black-on-white/white-on-black while in Auto-Page mode. Press the button again to exit Auto-Page mode.

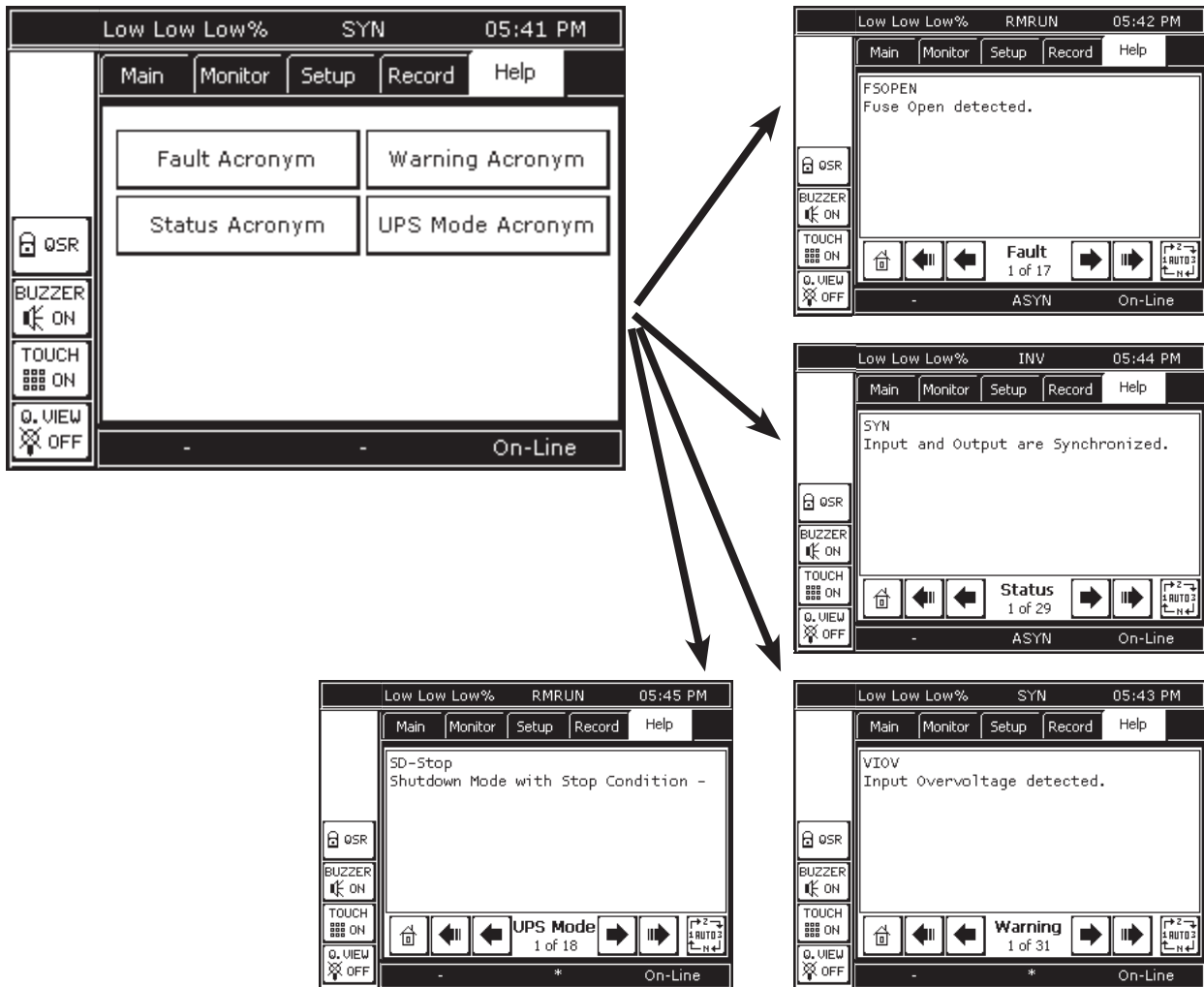

FIGURE 12.16 - HELP CATEGORIES

12.19 4300 Parameter Definitions

The following table lists those parameters that can viewed and/or changed at the User and Admin security level. Parameters are identified as a three digit number composed of the Block and Item number. E.g. Parameter 003 is the UPS serial number. The Short Descriptions is the labeling shown in the UPS display. REIII column indicates if a parameter can be viewed with RemotEye.

Blk	Item	Long Description	Short Description (Inside UPS)	Units	Permissions		Remark	RE III
					User	Admin		
0	01	UPS Manufacturer	Manufacturer		R	R		p
0	02	UPS Typeform	Typeform		R	R	See Toshiba UPS Typeform document.	p
0	03	UPS Serial Number	Serial No.		R	R	"YYYYMMNNNN Where YYYY is four digits year MM is two digits month NNNN is five digit number"	p
0	08	UPS System Name	System Name		R	R/W	Such as Plant3, Upstair...	p
0	09	UPS Attached Devices	Attached Device		R	R/W		p
0	10	UPS Installation Date	Installed Date		R	R/W	YYYYMMDD	p
1	01	Input Line to Line Voltage (AB)	Voltage (AB)	V	R	R		p
1	02	Input Line to Line Voltage (BC)	Voltage (BC)	V	R	R		p
1	03	Input Line to Line Voltage (CA)	Voltage (CA)	V	R	R		p
1	04	Input Line to Neutral Voltage (AN)	Voltage (AN)	V	R	R		p
1	05	Input Line to Neutral Voltage (BN)	Voltage (BN)	V	R	R		p
1	06	Input Line to Neutral Voltage (CN)	Voltage (CN)	V	R	R		p
1	07	Input Phase Current (A)	Current (A)	A	R	R		p
1	10	Input Frequency (A)	Freq (A)	dHz	R	R	600 for 60.0 Hz, 500 for 50.0 Hz. UPS will send you one decimal point and format it according to decimal points	p
1	11	Input Frequency (B)	Freq (B)	dHz	R	R	600 for 60.0 Hz, 500 for 50.0 Hz. UPS will send you one decimal point and format it according to decimal points	p
1	12	Input Frequency (C)	Freq (C)	dHz	R	R	600 for 60.0 Hz, 500 for 50.0 Hz. UPS will send you one decimal point and format it according to decimal points	p
1	21	Input Voltage in % (A)	Voltage (A)	%	R	R	Percentage of Line to Line and Line to Neutral Voltage are the same	p
1	22	Input Voltage in % (B)	Voltage (B)	%	R	R	Percentage of Line to Line and Line to Neutral Voltage are the same	p
1	23	Input Voltage in % (C)	Voltage (C)	%	R	R	Percentage of Line to Line and Line to Neutral Voltage are the same	p
1	40	No of Input Lines	No of Input Line		R	R		p

Blk	Item	Long Description	Short Description (Inside UPS)	Units	Permissions		Remark	RE III
					User	Admin		
1	41	Rated Line to Line Input Voltage	Rated Voltage L-L	V	R	R		p
1	42	Rated Line to Neutral Input Voltage	Rated Voltage L-N	V	R	R		p
1	43	Rated Input Current	Rated Current	A	R	R		p
1	45	Rated Input Power (W)	Rated Power (W)	W	R	R		p
1	46	Rated Input Power (VA)	Rated Power (VA)	VA	R	R		p
1	47	VIUV Detection Level	VIUV DeLevel	%	R	R		p
1	49	VIOV Detection Level	VIOV DeLevel	%	R	R		p
1	58	Enable Phase Check	En Phase Check		R	R		p
2	01	Output Line to Line Voltage (AB)	Voltage (AB)	V	R	R		p
2	02	Output Line to Line Voltage (BC)	Voltage (BC)	V	R	R		p
2	03	Output Line to Line Voltage (CA)	Voltage (CA)	V	R	R		p
2	04	Output Line to Neutral Voltage (AN)	Voltage (AN)	V	R	R		p
2	05	Output Line to Neutral Voltage (BN)	Voltage (BN)	V	R	R		p
2	06	Output Line to Neutral Voltage (CN)	Voltage (CN)	V	R	R		p
2	07	Output Phase Current (A)	Current (A)	A	R	R		p
2	08	Output Phase Current (B)	Current (B)	A	R	R		p
2	09	Output Phase Current (C)	Current (C)	A	R	R		p
2	10	Output Frequency (A)	Freq (A)	dHz	R	R	600 for 60.0 Hz, 500 for 50.0 Hz. UPS will send you one decimal point and format it according to decimal points	p
2	11	Output Frequency (B)	Freq (B)	dHz	R	R	600 for 60.0 Hz, 500 for 50.0 Hz. UPS will send you one decimal point and format it according to decimal points	p
2	12	Output Frequency (C)	Freq (C)	dHz	R	R	600 for 60.0 Hz, 500 for 50.0 Hz. UPS will send you one decimal point and format it according to decimal points	p
2	13	Output Power W (Total)	Power W (Total)	kW	R	R		p
2	21	Output Voltage % (A)	Voltage % (A)	%	R	R	Percentage of Line to Line and Line to Neutral Voltage are the same	p
2	22	Output Voltage % (B)	Voltage % (B)	%	R	R	Percentage of Line to Line and Line to Neutral Voltage are the same	p
2	23	Output Voltage % (C)	Voltage % (C)	%	R	R	Percentage of Line to Line and Line to Neutral Voltage are the same	p
2	24	Output Current % (Total)	Current % (Total)	%	R	R		p
2	25	Output Current % (A)	Current % (A)	%	R	R		p
2	26	Output Current % (B)	Current % (B)	%	R	R		p
2	27	Output Current % (C)	Current % (C)	%	R	R		p

Blk	Item	Long Description	Short Description (Inside UPS)	Units	Permissions		Remark	RE III
					User	Admin		
2	28	Output Power W % (Total)	Power W % (Total)	%	R	R		p
2	36	Output Power Factor	Power Factor		R	R		p
2	40	No of Output Line	No of Output Line		R	R		p
2	41	Rated Line to Line Output Voltage	Rated Voltage L-L	V	R	R		p
2	42	Rated Line to Neutral Output Voltage	Rated Voltage L-N	V	R	R		p
2	43	Rated Output Current	Rated Current	A	R	R		p
2	45	Rated Output Power (W)	Rated Power (W)	W	R	R		p
2	46	Rated Output Power (VA)	Rated Power (VA)	VA	R	R		p
2	47	VOUV Detection Level	VOUV DeLevel	%	R	R		p
2	49	VOOV Detection Level	VOOV DeLevel	%	R	R		p
3	01	Bypass Line to Line Voltage (AB)	Voltage (AB)	V	R	R		p
3	02	Bypass Line to Line Voltage (BC)	Voltage (BC)	V	R	R		p
3	03	Bypass Line to Line Voltage (CA)	Voltage (CA)	V	R	R		p
3	04	Bypass Line to Neutral Voltage (AN)	Voltage (AN)	V	R	R		p
3	05	Bypass Line to Neutral Voltage (BN)	Voltage (BN)	V	R	R		p
3	06	Bypass Line to Neutral Voltage (CN)	Voltage (CN)	V	R	R		p
3	10	Bypass Frequency (A)	Freq (A)	dHz	R	R	600 for 60.0 Hz, 500 for 50.0 Hz. UPS will send you one decimal point and format it according to decimal points	p
3	11	Bypass Frequency (B)	Freq (B)	dHz	R	R	600 for 60.0 Hz, 500 for 50.0 Hz. UPS will send you one decimal point and format it according to decimal points	p
3	12	Bypass Frequency (C)	Freq (C)	dHz	R	R	600 for 60.0 Hz, 500 for 50.0 Hz. UPS will send you one decimal point and format it according to decimal points	p
3	21	Bypass Voltage % (A)	Voltage % (A)	%	R	R	Percentage of Line to Line and Line to Neutral Voltage are the same	p
3	22	Bypass Voltage % (B)	Voltage % (B)	%	R	R	Percentage of Line to Line and Line to Neutral Voltage are the same	p
3	23	Bypass Voltage % (C)	Voltage % (C)	%	R	R	Percentage of Line to Line and Line to Neutral Voltage are the same	p
3	40	No of Bypass Line	No of Bypass Line		R	R		p
3	47	Bypass UV Detection Level	VbUV DeLevel	%	R	R		p
3	49	Bypass OV Detection Level	VbOV DeLevel	%	R	R		p
4	01	DC Bus Total	DC Bus Total	Vdc	R	R		p
5	01	Battery Voltage	Battery Voltage	Vdc	R	R		p
5	03	Battery Discharge Current	Discharge Current	Adc	R	R		p

Blk	Item	Long Description	Short Description (Inside UPS)	Units	Permissions		Remark	RE III
					User	Admin		
5	12	Equalized Setting	Auto Equal Ch		R	R/W		p
5	13	Equalized Charge Time	Equal Charge Time		R	R/W		p
5	14	Float Charging Voltage	Vchrg Float	Vdc	R	R/W		p
5	22	Low Battery Detection Level	Low Batt Level	Vdc	R	R		p
5	24	Battery Shutdown Level	Batt SDown Level	Vdc	R	R		p
5	27	Auto Battery Test	Auto Batt Test		R	R/W		p
5	28	Battery Auto Test Interval	Auto Test Interval	Sec	R	R/W		p
5	29	Battery Test at Startup	Batt Test @startup		R	R/W		p
5	30	Equalized Power Failure Duration	PFail Dur. Equal	Sec	-	R/W		p
5	31	Number of Batteries in Series	No Batt(Series)		R	R/W		p
5	32	Number of Batteries in Parallel	No Batt(Paral)		R	R/W		p
5	33	Rated Ampere Hour	Rated AHr		R	R/W		p
5	34	Battery Pack's C Rate	C Rate		-	R/W		y
5	35	Battery Installed Date	Batt Ins. Date		R	R/W		p
6	04	UPS Date	UPS Date		R	R/W		p
6	05	UPS Time	UPS Time		R	R/W		p
6	08	Current State	Current State		R	R	"0 - Shutdown 1 - Shutdown 2 - Shutdown 3 - Shutdown 4 - Shutdown 5 - Shutdown 6 - Bypass 7 - Bypass 8 - Bypass 9 - On-Line 10- On-Line 11 - BackUp 12 - CVCF 13 - Bypass 14 - Bypass 15 - Bypass 16 - Bypass 17 - Bypass"	p
6	11	Faults	Faults		R	R		p
6	12	Warnings	Warnings		R	R		p

Blk	Item	Long Description	Short Description (Inside UPS)	Units	Permissions		Remark	RE III
					User	Admin		
6	13	UPS Status(Comm)	UPS Status(Comm)		R	R		p
6	25	Service Port Baud Rate	Srv Port Baud		R	R	"0 - 9600 1 - 19200 2 - 38400 3 - 57600 4 - 115200"	p
6	27	RMT13 Port Baud Rate	RMT13 Port Baud		R	R	"0 - 9600 1 - 19200 2 - 38400 3 - 57600 4 - 115200"	p
6	31	Change Secu. Lvl	Change Secu. Lvl		R/W	R/W		p
6	32	Manage Admin PW	Manage Admin PW		-	R/W		p
6	33	Reset Admin PW	Reset Admin PW		R/W	R/W	"0 - Nothing 1 - Reset"	y
6	39	Enable RemotEye to Control UPS	En REye UPS Ctl		-	R/W		y
6	41	Inverter Start	Inverter Start		R	R		p
6	42	Remote Switch	Remote Bypass Switch		-	R/W		p
6	67	Auto Transfer	AutoXfer		R	R/W	"255 or 1 - Enable 0 - Disabled"	p
7	01	System Operation Time	System Op Time	Sec	R	R		p
7	02	Inverter Op Time	Inverter Op Time	Sec	R	R		p
7	23	Total Backups	Total Backups		R	R		p
7	25	Total Faults	Total Faults		R	R		p
7	27	Total Operations	Total Operations		R	R		p
8	01	Display Firmware Version	DFW Ver		R	R	"UXXYFVMMRRR T - Toshiba UPS XX - 2 Alpha Numeric UPS Product Line (43 - 4300) Y - uC Projects (M - Main, S - Sub, D - Display) FV - Firmware Version MM - Major version RRR - Minor version Note: Only display can write. Others, read only."	p
8	02	Display Firmware Built Date	DFW BDate		R	R	"Mmm DD, YYYY (Ex. Jan 04, 2006 Automatically read by compiler) Note: Only display can write. Others, read only."	p

Blk	Item	Long Description	Short Description (Inside UPS)	Units	Permissions		Remark	RE III
					User	Admin		
8	03	Display Firmware Built Time	DFW BTime		R	R	"HH:MM:SS (Ex. 18:45:45 Automatically read by compiler) Note: Only display can write. Others, read only."	p
8	06	Display Backlight Status	Sblight		R	R	"0: Off 1: On"	y
8	07	Display Sleep Timer	TMRsleep	Min	R/W	R/W		y
8	08	Buzzer	Buzzer		R/W	R/W	"0: Disable 1: Full Enable"	y
8	09	Buzzer Status	Sbuzzer		R	R	"0: Off 1: Idle 2: Alarm Sounding 3: Alarm Silenced"	p
8	11	Display Calibration	Cali Disp		R/W	R/W	"0 : Disabled 255 : Enabled Note: Only display can write. Others, read only."	y
8	21	User Interface Tone	UI Tone		R/W	R/W		y
8	25	Wired Blink @BK	Warning Led @BK		R/W	R/W	"0 - Enable 255 - Disable"	y
8	27	Expert Mode	Expert Mode		R/W	R/W	"0 - Enable 255 - Disable"	y
8	28	UI Tone Duration	UI Tone Duration	mS	R/W	R/W		y
8	50	RemotEye Installation Date	REye Ins Dat		R/W	R/W	"YYYYMMDD Note: Only RemotEye can write. Others, read only."	p
8	51	RemotEye Version	REye Ver		R/W	R/W	Note: Only RemotEye can write. Others, read only.	p
8	52	RemotEye IP Address	REye IP		R/W	R/W	"Ex. ""10.128.33.5"" Cfg. Of RE parms can be done via re comm.port Note: Only RemotEye can write. Others, read only."	p
8	53	RemotEye Network Mask Address	REye Mask IP		R/W	R/W	"Ex. ""255.0.0.0"" Note: Only RemotEye can write. Others, read only."	p
8	54	RemotEye Gateway Address	REye Gway IP		R/W	R/W	"Ex. ""10.128.33.1"" Note: Only RemotEye can write. Others, read only."	p
8	55	RemotEye Installation Status	Sreye		R/W	R/W	Note: Only RemotEye can write. Others, read only.	p
8	57	RemotEye Data Link Status	Sreye Datlink		R/W	R/W	"0: Unknown 1: Link Down 2: Link Up Note: Only RemotEye can write. Others, read only."	p
8	58	RemotEye Network Link Status	Sreye Netlink		R/W	R/W	"0: Unknown 1: Link Down 2: Link Up Note: Only RemotEye can write. Others, read only."	p

12.20 System Fault Messages

A Fault message is generated when either a fault condition occurs, or a warning condition occurs three times within ten minutes. The table below shows the possible fault messages and what actions need be taken.

If the input voltage is normal when the fault occurs then the UPS will switch immediately to the bypass mode to continuously feed power to the load.

If the fault condition occurs while the input power is abnormal and the UPS is in Bypass mode the UPS will shut down the output to prevent load equipment damage.

When a Fault condition exists, the red LED on the UPS display panel will illuminate until the fault is cleared.

TABLE 12.5 - SYSTEM FAULT MESSAGES

Display	Meaning	Action
BYPOH	Bypass Overheat – Overheating condition occurred.	Check unit for blocked or in-operable fan. Lower ambient temperature if it is greater than 104 °F (40 °C). Bypass operation will also cease if overheat condition is not corrected within 1 hr. of inverter shutdown. Try restarting. If condition re-occurs plan for total shutdown and call for service.
CL	Current Limit – UPS not within specifications.	Contact the nearest Toshiba authorized representative for service.
COV	Charger Overvoltage – Charger overvoltage condition occurred.	Contact the nearest Toshiba authorized representative for service.
DCOC	DC Bus Overcurrent – DC overcurrent condition occurred.	UPS is possibly faulty. Check the UPS operation conditions at time of fault. Not advisable to restart the UPS. Call for service.
DCOV	DC Bus Overvoltage – DC overvoltage condition occurred.	UPS is possible faulty, input wiring error, input overvoltage or connection of a motor load. Try restarting. If condition persists call for service.
DCUB	DC bus unbalanced.	UPS is possibly faulty. Check the UPS operation conditions at time of fault. Not advisable to restart the UPS. Call for service.
DCUVBS	DC Bus Undervoltage during Boostup Mode – DC Bus undervoltage condition occurred.	UPS is possibly faulty. Check the UPS operation conditions at time of fault. Not advisable to restart the UPS. Call for service.
DCUVC	DC Bus Undervoltage During Charging Mode – DC Bus undervoltage condition occurred.	UPS is possibly faulty. Check the UPS operation conditions at time of fault. Not advisable to restart the UPS. Call for service.
DOH	Device Overheat – Overheating condition occurred.	Reduce equipment load to 100% or less and try restarting.
OOO	Output Overcurrent – UPS is overloaded.	Shutdown excess equipment to reduce load.
PHBRER	Bypass phase rotation error.	Bypass phase rotation is reversed. Switch any two input cable connections: A and B, B and C, or C and A.

Display	Meaning	Action
PHIRER	Input phase rotation error.	Input phase rotation is reversed. Switch any two input cable connections: A and B, B and C, or C and A.
UPSOL	UPS Overload.	Reduce equipment load to 100% or less.
VOOV	Output Overvoltage – Output over-voltage condition occurred.	UPS is possibly faulty. Check the UPS operation conditions at time of fault. Not advisable to restart the UPS. Call for service.
VOUV	Output Undervoltage – Output undervoltage condition occurred.	UPS is possibly faulty. Check the UPS operation conditions at time of fault. Not advisable to restart the UPS. Call for service.

12.21 System Warning Messages

Warning messages are generated when a noncritical abnormal operating condition occurs. The following tables shows possible messages and their meaning.

When a Warning condition exists, the amber LED on the UPS display panel will flash for the duration of the Warning condition.

TABLE 12.6 - SYSTEM WARNING MESSAGES

Display	Meaning	Action
ASYN	Asynchronous mode – Input and output frequency are different. Bypass is disabled.	No Action Needed.
BLFEND	Battery Lifetime End – Batteries at end of life.	Have batteries replaced immediately.
BLFNE	Battery Lifetime Near End – Batteries are nearing the end of their expected lifetime.	Contact the nearest Toshiba authorized representative to arrange for battery replacement.
BMCCBO	Battery MCCB is OFF - Backup power is not available.	Switch Battery Breaker ON.
BOH	Battery Overheat – Battery not within specifications.	Contact the nearest Toshiba authorized representative for service.
BTFAIL	Battery Test Failed – Battery not within specifications.	Contact the nearest Toshiba authorized representative for service.
BYP	UPS is in bypass mode.	Switch UPS On-Line.
CALL	Service Call Required – Inspection of the unit is advised.	Have inspection/service performed.
COV	Charger Overvoltage – Battery Charger not within specifications.	Contact the nearest Toshiba authorized representative for service.
CL	Current Limit – UPS not within specifications.	Contact the nearest Toshiba authorized representative for service.
EEUPDER	EEPROM Update error.	Contact the nearest Toshiba authorized representative for service.

Display	Meaning	Action
EE2RAER	EEPROM to ROM loading error.	Contact the nearest Toshiba authorized representative for service.
FIBYER	Input/Bypass Frequency Error – Input frequency outside of UPS specifications.	Depends on UPS mode.
INVOL	Inverter overload.	Shutdown excess load equipment to reduce load.
MCCBTRP	UPS input MCCB tripped open.	
NOCOM	No communication between main controller and display.	Contact the nearest Toshiba authorized representative for service.
OL110	Overload – UPS is overloaded (110% and above) Unit will switch to bypass operation or shut down if no action is taken.	Shut down excess equipment to reduce load.
REYDNER	RemotEye Downlink error (main and communication error).	Contact the nearest Toshiba authorized representative for service.
REYE-UPER	RemotEye Uplink error.	Contact the nearest Toshiba authorized representative for service.
RO2EEER	ROM to EE error.	Contact the nearest Toshiba authorized representative for service.
SOH	System overheat.	Contact the nearest Toshiba authorized representative for service.
SRV-232ER	RS-232 service port error.	Contact the nearest Toshiba authorized representative for service.
STFAIL	System test failed.	Contact the nearest Toshiba authorized representative for service.
VBNG	Battery voltage is not good.	Contact the nearest Toshiba authorized representative for service.
VBLO	Battery Voltage low.	Battery backup is xx% depleted.
VBSD	Battery voltage reached shut-down level.	Battery backup is exhausted. UPS will shut down until utility power is restored.
VBYOV	Bypass overvoltage.	Restore On-Line operation as soon as possible.
VBYUV	Bypass under voltage.	Restore On-Line operation as soon as possible.
VIOV	Input Overvoltage – Input voltage exceeds UPS specifications.	Depends on UPS mode.
VIUV	Input Undervoltage – Input voltage less than UPS specifications.	Depends on UPS mode.

12.22 System Mode Messages

A UPS Mode message is generated when the UPS changes operating mode. The following tables list the possible operating modes for the UPS.

TABLE 12.7 - SYSTEM MODE MESSAGES

Display	Meaning
Backup	Backup – Power comes from other than input.
BattTest	Battery Test – Battery test in progress.
Bypass	Bypass – UPS is offline, power is being provided directly from UPS input.
On-Line	On-Line – Input converter and inverter are running (Double conversion mode).
Shutdown	Shutdown – No output, DC Bus is charged through Soft-start Resistor.
Startup	Startup – UPS is starting up.

12.23 System Status Messages

A UPS Status message is generated when the UPS changes its status (from inverter to bypass mode, for example). The table below shows the possible Status messages and their meaning.

TABLE 12.8 - SYSTEM STATUS MESSAGES

Display	Meaning	Action
ARTEN	Auto Retransfer Enable	No action needed.
BYP	Bypass mode – Power is supplied by UPS input.	No action needed.
BYPEN	Bypass Enable	No action needed.
DEFCAL	Touchscreen is using default values instead of calibrated values.	No action needed.
DLYSTRUP	Delay Start – UPS is counting down prior to startup.	No action needed.
EE1ST	EEPROM is loaded with default values.	No action needed.
EPO	EPO circuit is active.	Reset EPO switch to start.
EQCHRG	Equalized Charging	No action needed.
FLT	A fault has occurred.	See Fault records.
FRCDDBYP	UPS forced into bypass mode.	Secure the load and contact the nearest Toshiba authorized representative for service.
FWUPD	Firmware updated.	No action needed.
INVSTUP	UPS starts up in inverter mode (skips bypass)	No action needed.
INV	Inverter mode.	Inverter is running (it can be On-Line, Battery Test, or Backup)
LANSD	UPS goes to Shutdown triggered from LAN SD (shutdown) circuit.	Deactivate LAN shutdown signal to reset.

Display	Meaning	Action
LB	Low Battery – The battery voltage has dropped low (about 90% or less) during operation. Continued operation in this mode will deplete battery and cause output shut down. (This can be adjusted by the operator)	Immediately shut down the load equipment in an orderly fashion and then press the STOP key.
LCRUN	Local run command issued.	No action needed.
MANUAL	UPS is in Manual mode	No action needed.
OUT50HZ	UPS set for 50 Hz Output.	No action needed.
PFAIL	Input power failure.	No action needed.
PRCHRG	Protective charging	No action needed.
RMTSD	Remote shutdown occurred.	One or more warnings occurred. Check the Warnings field for details. Disconnect LAN signal to reset.
RMTSWEN	Remote switch control enable.	No action needed.
SYN	Synchronous mode.	Input and output are synchronized.
TIMEDSD	UPS is counting down prior to shutdown.	Immediately shut down the load equipment in an orderly fashion and then press the STOP key.
WRN	A warning has occurred.	See Warning record.

13. UPS Operation

The 4300 UPS is hardwired to both utility power and the critical loads. The two main operating states are

1. On-Line with the UPS providing clean power to the load.
2. Bypass, where the power is routed around the converter-inverter of the UPS and fed directly to the load.

A Third state, Emergency shut-down, is for emergency use only and is discussed separately in Section 12.3.

The UPS can be switched between On-Line and Bypass by switching the knob switch located below the touchscreen display.

13.1 Initial UPS Startup

The first time the UPS is started after installation, use the touchscreen to enter the current time and date.

1. Start the UPS as described in 13.2 steps 1-5.
2. Enter the **System Date**:

Press the **Setup** tab.

Press **System Date** in the Data Display Area.

Enter the date in the following format: **Www Mmm DD YYYY**

Www is the three character day of the week: Mon, Tue, Wed...

Mmm is the three character Month: Jan, Feb, Mar...

DD is the two digit day of the month: 01, 12, 30...

YYYY is the four digit year: 2011

Press **Write** to store the date.

Press **Quit** to exit **System Date** setup.

3. Enter the **System Time**:
Press the **Setup** tab.

Press **System Time** in the Data Display Area.

Enter the Time in the following format: **HH:MM AM**

HH is the two digit hour followed by a colon (:)

MM is the two digit month.

AM/PM is before or after noon.

Press **Write** to set the time.

Press **Quit** to exit System Time setup.

13.2 Starting/Stopping the UPS

1. Switch the main circuit breaker (MCCB) on the inside front of the UPS to the **ON** position.
2. Switch on the optional second Circuit Breaker if the UPS is equipped with dual inputs. The breaker(s) should normally remain in the **ON** position. Switch on the External Battery Cabinet breaker, if available.
3. Verify that the **On-Line** LED on the front panel lights green. All LED's on the front panel may light for a moment when the input breaker is turned on. This is normal. The UPS will now be supplying power in the bypass mode.

NOTICE

When running the UPS for the first time or after the power failure backup operation, charge the battery cabinet batteries, if any, for at least 24 hours (input breaker on) before operating the connected load.

Using the UPS without charging the battery shortens the battery backup operation time, which may result in the loss of data in case of a power failure.

4. Switch the **Bypass/On-Line** knob to **On-Line** to begin UPS operation.
5. Press the **Quick View** button on the Quick Access Toolbar and verify the UPS has input/output power. If the UPS has backup batteries, verify the batteries are being charged.

13.3 Stopping the UPS

To stop the UPS, switch the **Bypass/On-Line** key to **Bypass**. The **On-Line** LED changes from green to off. The UPS is now in Bypass mode.

NOTICE

If the input breaker is turned off while UPS is in the bypass state, the output power stops. Any load devices will lose power.

Ensure that all sensitive loads have been previously shut down.

To completely stop the UPS, open/turn off; the input breaker MCCB, the secondary Input breaker (if available), and the External Battery Cabinet breaker (if available).

13.4 Battery Backup Time and Discharge Process

The optional 43TBC battery cabinet provides approximately 7 or more minutes of back-up time depending on the UPS kVA rating and system load. The exact length of these times will depend on the UPS model used, condition of the batteries, amount and type of load, temperature and other variables.

Figure 13.1 graphically illustrates the battery discharge process from a full load condition.

Excessive discharge will cause the UPS battery voltage to drop. The chart shown below lists the voltage level at which each UPS low-voltage alarm will sound and at what level the low-voltage condition will cause the unit to automatically shut down.

UPS Capacity	30 kVA	50 kVA
Nominal voltage (V_{nom})	288 Vdc	288 Vdc
Alarm voltage (V_{low})	246 Vdc	246 Vdc
Shutdown voltage (V_{min})	230 Vdc	230 Vdc

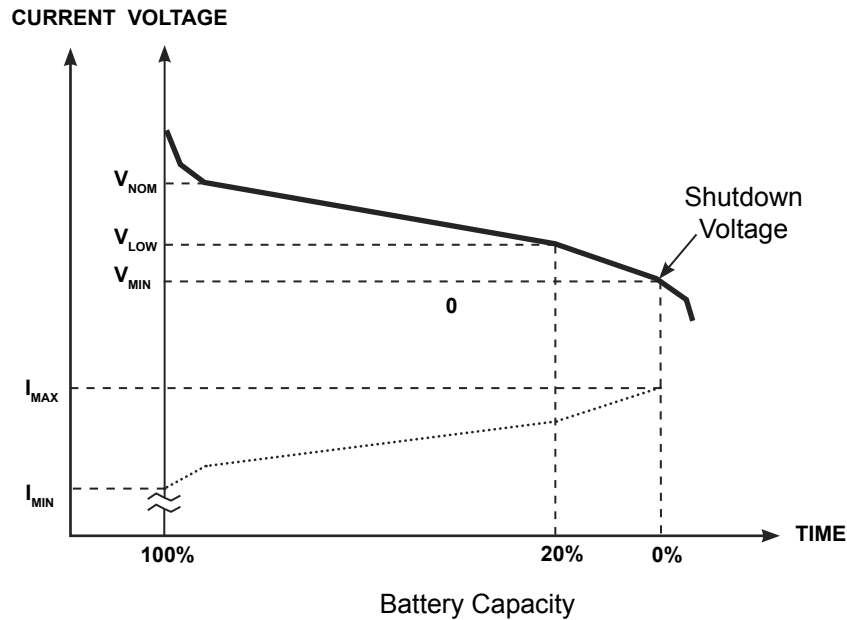

FIGURE 13.1 - TYPICAL BATTERY DISCHARGE CURVE

13.5 Battery Low Voltage Tolerances

The battery charging period varies depending on the amount of discharge during backup. Figure 13.2 shows the typical recharge curve for a fully discharged battery.

Charging Period	Explanation
Period 1	Initial charging at maximum current (limited by charger). V_{min} is minimum voltage at which the UPS will shut down power to the load.
Period 2	Charging rate drops as battery voltage increases.
Period 3	Battery cells are at maximum voltage, UPS continues to provide a "trickle charge" to keep the batteries a maximum charge capacity.

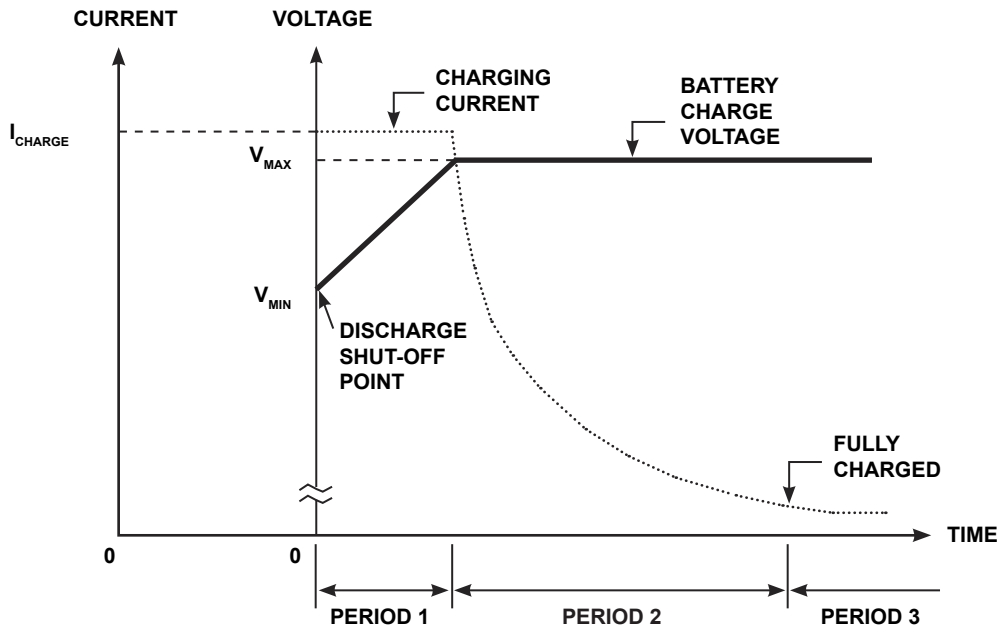

FIGURE 13.2 - TYPICAL BATTERY CHARGING CURVE

13.6 Battery Equalize Charge Mode

The UPS has a Battery Equalize Charge Mode that can be initiated by the user if the function is enabled. The UPS ships with this function disabled by default.



The Battery Equalize Charge Mode must be enabled by an authorized factory representative (typically during initial startup.)

Once Enabled, the Equalize Charge on Batteries mode (Parameter 539) can be initiated for a preset charge time by accessing Parameter 539 and selecting "Enable". At the completion of the charge time in parameter 513 the charging voltage will return to normal

13.7 Audible Alarm Functions

An audible alarm (buzzer) will sound when the UPS is in the battery backup mode, has a fault, has low battery voltage, or is in an overload condition. The buzzer will also beep each time an effective item is touched on the touchscreen. The following chart shows the buzzer pattern durations for each condition. Time units are shown in seconds.

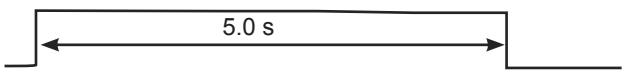
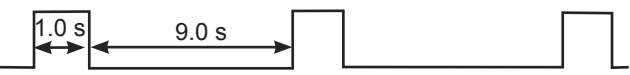
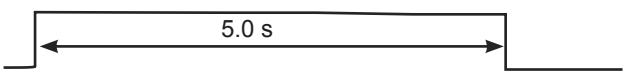
TABLE 13.2 - AUDIBLE ALARMS

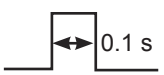
Condition	Audible Pattern
Any Fault (Intermittent buzz until fault clears)	
Switch to Backup (Single five-second buzz)	
Backup Operation (Intermittent buzz once every ten seconds)	
UPS Battery Shutdown Voltage (Batt. Voltage 79% Normal)	
Warnings: OL110 (Overload Timer) LB (Low Battery - Batt. Voltage 90% Normal) BLFN (Battery Life Pre-alarm - Batt expires in 6 mo.) BLFE (Battery Life End) CHRGOV (Charger Over Voltage) BTSTFL (Battery Test Fail) BOH (Battery Overheat) AOH (Ambient Overheat) CLMT (Current Limit) DCER (Display Disconnected) BDEPL (Battery Depletion)	
Touching Effective Item on Touchscreen	

The buzzer can be silenced most easily by pressing the Buzzer Silent button on the Quack Access Toolbar.

Alternatively, the buzzer can also be silenced by selecting the Settings tab, then set the Buzzer Silent parameter to Disable. This will turn off the buzzer for the current alarm status, but the buzzer will still sound when the next Fault/Warning condition occurs.

The buzzer can be disabled permanently by selecting the Settings tab then setting the parameter **Buzzer Disable** to Disable. This will disable the alarm so that no alarm sounds for any Fault or Warning condition.

14 Options

14.1 Ancillary Cabinets: Transformer, UPS, Battery.

The 4300 is designed as part of a product line of line-up-and-match cabinets. A full installation of all ancillary support cabinets is shown in figure 14.1. The ancillary units should be installed in the relative order shown below. Contact the factory for full specifications.



FIGURE 14.1 - OPTIONAL ANCILLARY SUPPORT CABINETS

14.2 4300 Options

The 4300 has the following option available:

- Kick Plate Set - Easily installed kick plates that match the color and texture of the UPS exterior. (See Appendix B.)
- Air Filter Kit - Air filter for the front door of the 4300 UPS, Transformer/Auxiliary, and Battery Cabinets. (See Appendix C.)

Contact the factory for pricing.

15 External Layouts/Dimensions/Shipping Weights

Dimensional Data

TABLE 15.1 - DIMENSIONAL DATA

EXTERNAL DIMENSIONS		
Unit	30 kVA	50 kVA
Height	73.7 in. (1872 mm)	73.7 in. (1872 mm)
Width	22.1 in. (561 mm)	22.1 in. (561 mm)
Depth	30.7 in. (779 mm)	30.7 in. (779 mm)

Electrical Conduit Knock-out Data

TABLE 15.2 - CONDUIT KNOCKOUT DIMENSIONS

CABLE ACCESS OPENING SIZES (30/50KVA)	
Left/Right Side	6 in. (152 mm) x 9 in. (229 mm)
Top	4.75 in. (121 mm) x 16.5 in. (419 mm)
Bottom	4.75 in. (121 mm) x 16.5 in. (419 mm)

Unit and Shipping Weights

TABLE 15.3 - UNIT AND SHIPPING WEIGHTS

Model	Unit Weight		Shipping Weight	
	Pounds	Kilograms	Pounds	Kilograms
30 kVA	788	357	838	380
50 kVA	867	393	917	416

1. Subject to change without notice.

PARAMETERS	50 KVA
UNIT WEIGHT (LBS/KGS)	846 / 380.7
VENTILATION REQTS.	FRONT 20"; TOP 12"
FINISH	0'BRIEN BLACK

NOTE: SEE MANUAL FOR COMPLETE SPECIFICATIONS

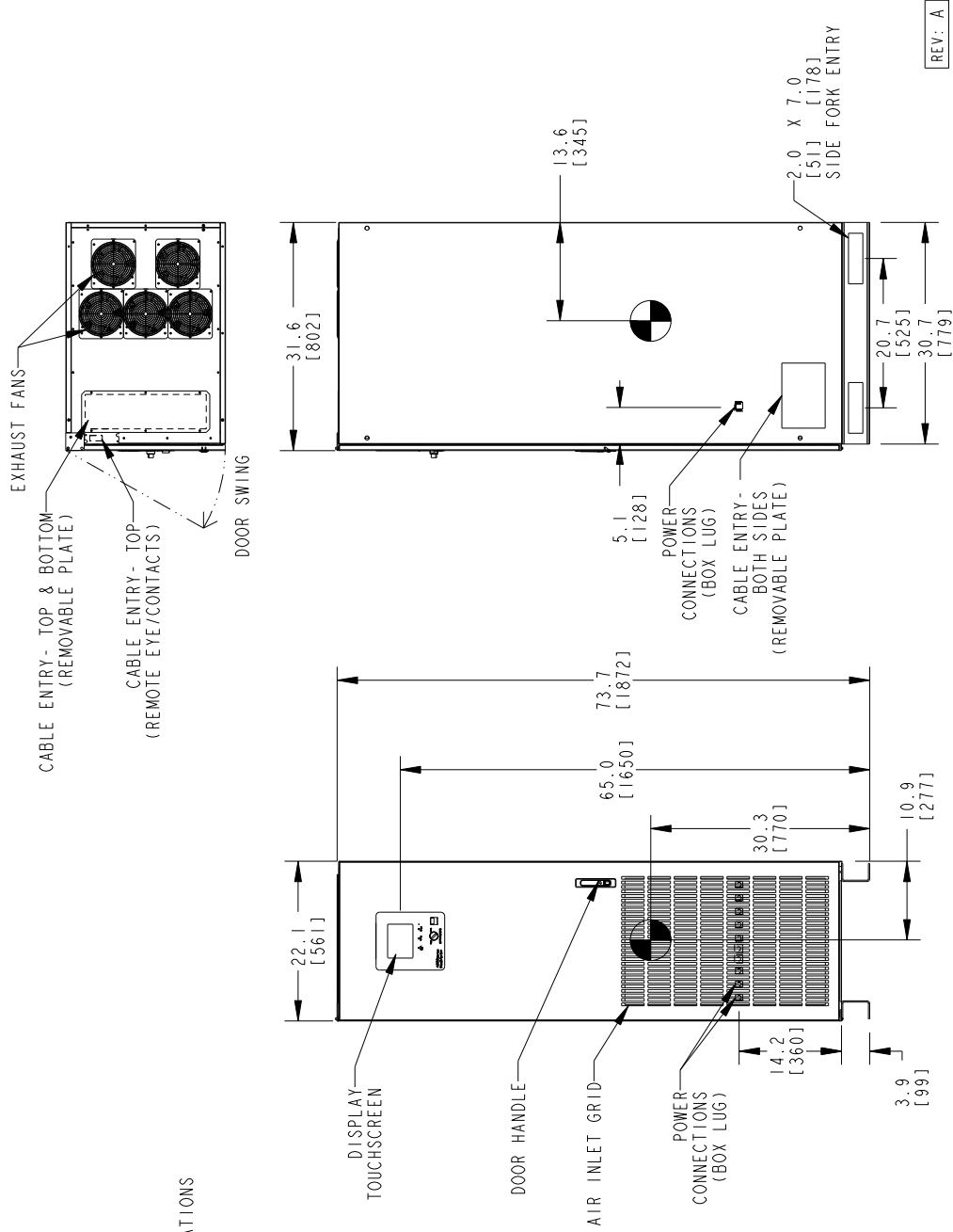

TOLENANCE:
XX TO ±.03
.XXX TO ±.015
.XXXX TO ±.005

FIGURE 15.1 - 4300 30 KVA PHYSICAL DIMENSIONS

PARAMETERS	50 KVA
UNIT WEIGHT (LBS/KGS)	846 / 380.7
VENTILATION REOTS.	FRONT 20"; TOP 12"
FINISH	0'BRIEN BLACK

NOTE: SEE MANUAL FOR COMPLETE SPECIFICATIONS

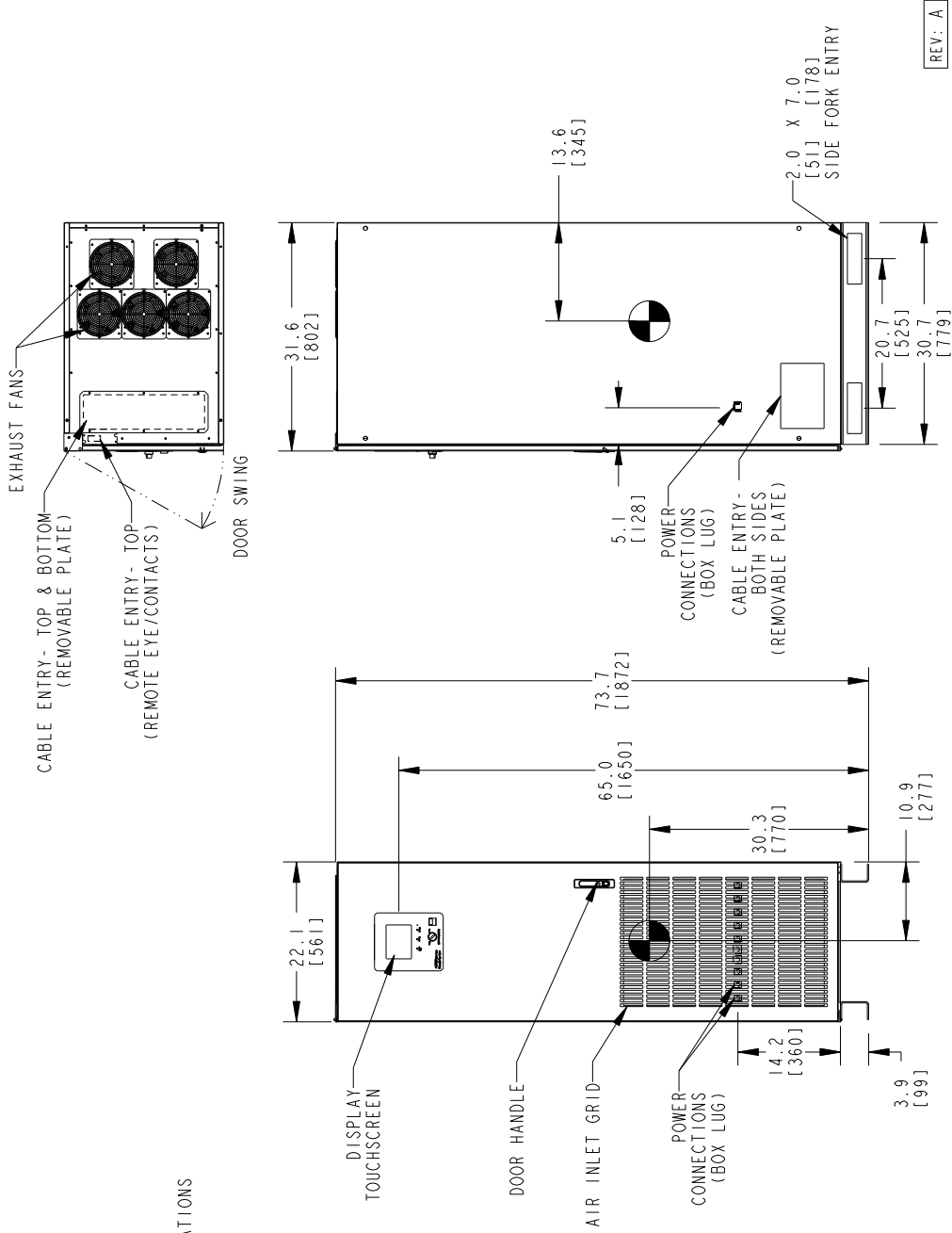

TOLERANCE:
.03
XXX TO ±.015
.XXXX TO ±.005

REV: A

FIGURE 15.2 - 4300 50 KVA PHYSICAL DIMENSIONS

Appendix A - Installation Planning Guide

TOSHIBA 4300 UPS

Installation Planning Guide for 30/50kVA UPS

Standard System: 208/120V Input, 208/120V Output

1. Maximum Current required at Primary AC Input based on full load output and maximum battery charging current.
2. Output load conductors are to be installed in separate conduit from input conductors.
3. Control wires and power wires are to be installed in separate conduits.
4. Recommended AC input and output overcurrent protection based on continuous full load current per NEC.
5. Wiring shall comply with all applicable national and local electrical codes.
6. Grounding conductors to be sized per NEC Article 250-122. Neutral conductors to be sized per NEC Article 310.15.
 - Primary AC Input: 3 ϕ , 4-wire + ground.
 - AC Output: 3 ϕ , 4-wire + ground.
 - DC Input: 2-wire (Positive/Negative) + ground.
7. Nominal battery voltage based on the use of VRLA type batteries (2.0 volts / cell nominal).
8. Maximum battery discharge current based on lowest permissible discharge voltage of 1.6 VPC.
9. DC wires should be sized to allow not more than a 2-volt drop at maximum discharge current.
10. Sizing calculations based on the following assumptions:
 - Not more than 6 current-carrying conductors installed in steel conduit in ambient temperature of 30 degrees C.
 - Temperature rating of conductors and terminals: 75 deg. C.
 - Feeder distance calculations based on NEC Chapter 9, Tables 8 and 9 data, allowing for 2% AC voltage drop.
 - Reference: 2005 NEC Handbook. Consult latest edition of applicable national and local codes for possible variations.
11. Ratings of wires and overcurrent devices are suggested minimums. Consult with a registered Professional Engineer within your local area for proper size selections.

TOSHIBA INTERNATIONAL CORPORATION

13131 West Little York Road

Houston, TX 77041

Telephone: 800.231.1412; 713.466.0277

Fax: 713.896.5212

Corporate Web Site: www.tic.toshiba.com

Group Web Site: www.toshibaups.com

TOSHIBA 4300 UPS

Installation Planning Guide for 30/50kVA UPS

Standard System: 208/120V Input, 208/120V Output

General Mechanical Information			
UPS kVA/ kW Rating	Dimensions (W x D x H)	Weight	Approximate Full-Load Heat Loss
	Inches	Lbs.	kBtu/Hr
30 kVA/ 24 kW	22 x 31.5 x 73.26	788	9.0
50 kVA/ 45 kW	22 x 31.5 x 73.26	867	15.2

Primary AC Input (208/120V 3-Phase / 4-Wire)					
Maximum Input Power Demand			Suggested External Feeder Breaker	Suggested Minimum Feeder Wire Size Per Phase // Neutral	Suggested Maximum Feeder Length For Min. Wire Size in Steel Conduit
kVA	PF	Amps	Feet	AWG or kcmil at 75° C Temp. Rating	Feet
30	>0.99	82 (90)	125 A	1/0 // 250 kcmil	380
50	>0.99	138 (148)	200 A	4/0 // 500 kcmil	380

Bypass AC Input (208/120V 3-Phase / 4-Wire)					
Maximum Input Power Demand			Suggested External Feeder Breaker	Suggested Minimum Feeder Wire Size Per Phase // Neutral	Suggested Maximum Feeder Length For Min. Wire Size in Steel Conduit
kVA	PF	Amps	Feet	AWG or kcmil at 75° C Temp. Rating	Feet
30	>0.99	83	110 A	1/0 // 250 kcmil	380
50	>0.99	139	175 A	4/0 // 500 kcmil	380

Battery Input (288VDC Nominal)					
Battery Capacity Required for Full Load Output		Maximum Discharge at Full Load Output	Suggested External Feeder Breaker	Suggested Minimum Feeder Wire Size Per Phase	Suggested Maximum Feeder Length For Min. Wire Size in Steel Conduit
	kWB	Amps DC	Amps	AWG or kcmil at 75° C Temp. Rating	Feet
30	29	127	150 A	1/0	70
50	49	214	250 A	4/0	70

AC Output (208/120V 3-Phase / 4-Wire)					
Rated Output Power			Suggested External Feeder Breaker	Suggested Minimum Feeder Wire Size Per Phase // Neutral	Suggested Maximum Feeder Length For Min. Wire Size in Steel Conduit
kVA	PF	Amps	Amps	AWG or kcmil at 75° C Temp. Rating	Feet
30	0.9	83	110 A	1/0 // 250kcmil	380
50	0.9	139	175 A	4/0 // 500 kcmil	380

Important Notes:

Min-Max Lug Cable Capacity:

- Power Terminals (AC Input, AC Output, AC Secondary Input) – #6 to 250 kcmil
- Neutral Terminals – 1/0 to 500 kcmil
- Battery Terminals – #6 to 250 kcmil

Appendix B - Optional Kickplate Installation

Purpose

This Installation Guide shows how to correctly install the optional 4300 Series Kick Plates on the 4300 UPS, 431A Ancillary Cabinet, and the 431B Battery Cabinet. These instructions are also available in the Manuals for the respective cabinets.

Toshiba International Corporation reserves the right, without prior notice, to update information, make product changes, or discontinue any product or service identified in this publication.

Toshiba International Corporation shall not be liable for direct, indirect, special, or consequential damages resulting from the use of the information contained within this Installation Guide.

Box Contents

Part Number	4310-30/50-KP-A	4310-30/50-KP-B
Instruction Sheet (P/N 66597)	1	1
F/B (Front/Back) Kick Plate, 22 in.	2	2
Side Kick Plate, 30.5 in.	2	(None)
NOTES	Initial set of kick plates to enclose the base of one 4300 cabinet.	Add-on kick plates to enclose additional cabinets. The sides kick-plates are moved to the outer sides of outermost cabinets in the lineup.
	Both pair of kick plates are symmetrical - there is no upside down.	

Tools Required

None - The kick plates consist of the F/B panels that magnetically latch to the welded base of the 4300 Series cabinets and a second pair (sides) that magnetically latch to the F/B plates.

Installing 4310-30/50-KP-A

NOTE: Due to variations within manufacturing specifications, the spacing on the base channels may be slightly more or less than the separation between the magnetic latches of the kick plates.

To correct this the installer should bend the magnetic latch support tab slightly to ensure a snug fit to the base channels.

STEP 1: Fit the F/B Plates with the UPS C-channel skids.

- 1.1 Place a F/B kick plate on edge on the floor, magnetic latches side toward the UPS with the magnetic latch faces facing left. See Figure 1.
- 1.2 Place one in front and one at the back of the UPS.
- 1.3 Slide the front F/B kick plate forward until both magnet latches adhere to the left and right vertical C-channel base skid member.
- 1.4 If one of the magnets does not latch firmly, or the spacing is too narrow, bend one or the other of the magnetic latch supports in or out as required to ensure a good fit. See Figure B1.
- 1.5 Repeat Step 1.3 and 1.4 for the F/B kick plate at the back of the UPS.
- 1.6 Remove the F/B kick plates from the C-channel base skids.

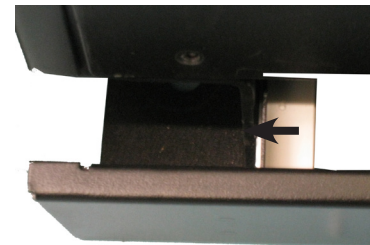

Left Base Skid



Right Base Skid

Figure B1

STEP 2: Slide Side Plates in along C-Channel base.

- 2.1 Facing the front of the UPS, slide a side kick plate with the smooth side facing out down along the left base C-channel skid until it is protruding about one inch in front of the UPS. See Figure B2.
- 2.2 Repeat for the right C-channel skid.

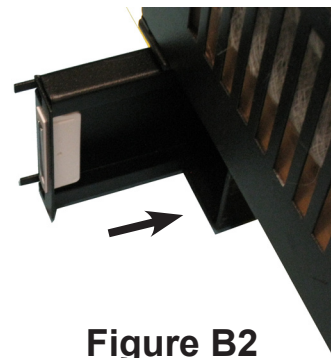

Figure B2

STEP 3: Align the F/B Plate with the UPS front.

Place a F/B kick plate on the floor as in Step 1. Angle the right edge out away from the UPS until the pair of front slots at the ends of the F/B kick plate are visible. See Figure B3.

STEP 4: Insert Side Plate tabs into F/B Plate slots.

Insert the side plate tabs into the F/B kick plate slots on the floor in front of the UPS, and then slide the right edge out until the pair of front slots at each end of the plate are visible. See Figure B3.

- 4.1 Carefully slide the F/B kick plate forward until the Side plate tabs are inserted in the F/B kick plate slots. (*NOTE - This is a snug fit.*)
- 4.2 Slide the right side of the F/B kick plate forward to engage the tabs of the right Side kick plate.
- 4.3 Slide the F/B kick plate forward until the left and right Side kick plate magnetic latches make contact with the F/B kick plate.
- 4.4 Slide the F/B kick plate back until it make contact with both the C-channel base skids.

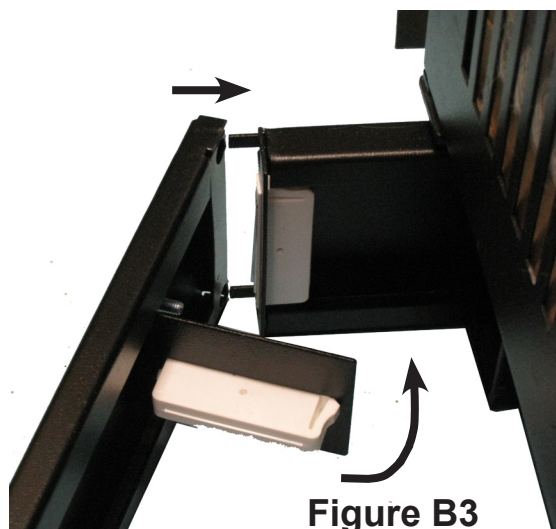

Figure B3

STEP 5: Attach the rear F/B Plate to the back of the UPS

Repeat Step B4 for the F/B kick plate at the rear of the UPS.

Completion

When the kick plates are properly installed, the front panel will be nearly flush with the front (Figure B4). The side kick plate will be inset about a quarter inch from the vertical side plane (Figure B5), and the back F/B kick plate will extend out about a quarter inch beyond the vertical back plane of the UPS (Figure B6).

Figure B4

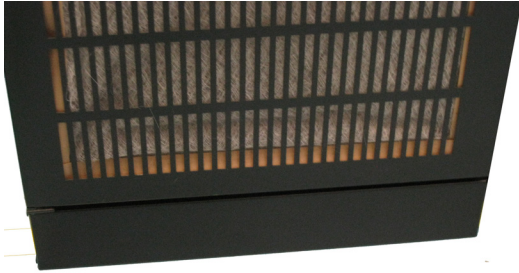

Front Kick Plate

Figure B5



Side Kick Plate

Figure B6



Back Kick Plate

Installing 4310-30/50-KP-B

The 4310-30/50-KP-B Kick Plate Kit contains one pair of F/B kick plates. This kit is required for each standard additional 4300 Series add on frame, such as the 431A and 431B. The 431M is already provided with a base skirt.

NOTE: Due to variations within manufacturing specifications, the spacing on the base channels may be slightly greater of less than the separation between the magnetic latches of the kick plates.

To correct this the installer should bend the magnetic latch support tab slightly to ensure a snug fit to the base channels.

STEP 1: Move Side Plates to outer-most C-channel base

Move the Side kick plates to the the outer sides of the assembled 4300 Series units. See Figure 7, 8.

STEP 2: Install the F/B Plates

Install the F/B kick plates as described on Pages 73-75.

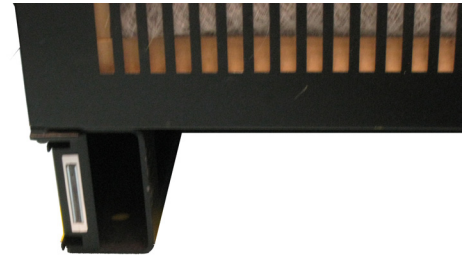

Figure 7

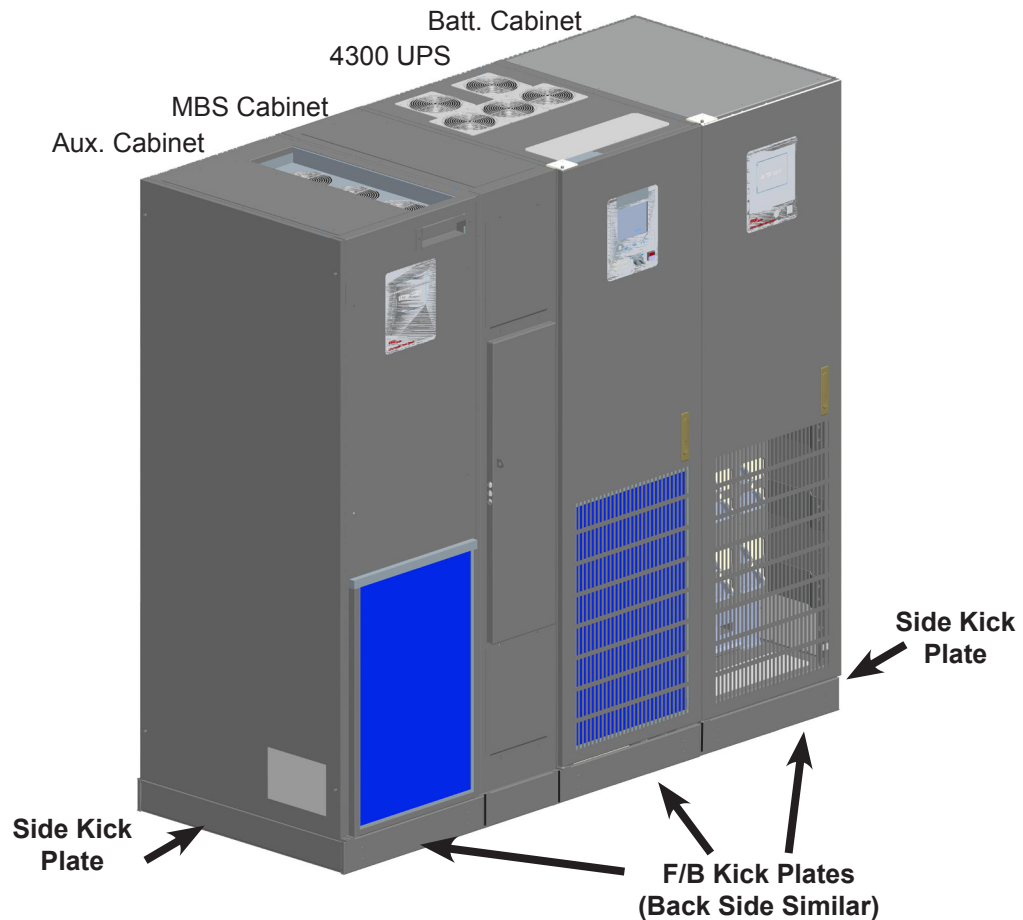

Figure 8

Appendix C - Optional Air Filters

Purpose

The front doors of the 4300 30/50kVA UPS, Transformer/Auxiliary, and Battery Cabinet are equipped to mount optional air filters. All these units use the same size filter. (See Air Filter Specs, below.)

Air Filter Specs.

Part Number	Dimensions	Filtration Rating	Filter Backing
Toshiba P/N 64233	20" x 30" x 1"	MERV 7	Plastic (Non-conductive)

Tools Required

None - The kick plates consist of the F/B panels that magnetically latch to the welded base of the 4300 Series cabinets and a second pair (sides) that magnetically latch to the F/B plates.

get pics of Xfmr cab and inst of filters.

Tool needed to unscrew this?

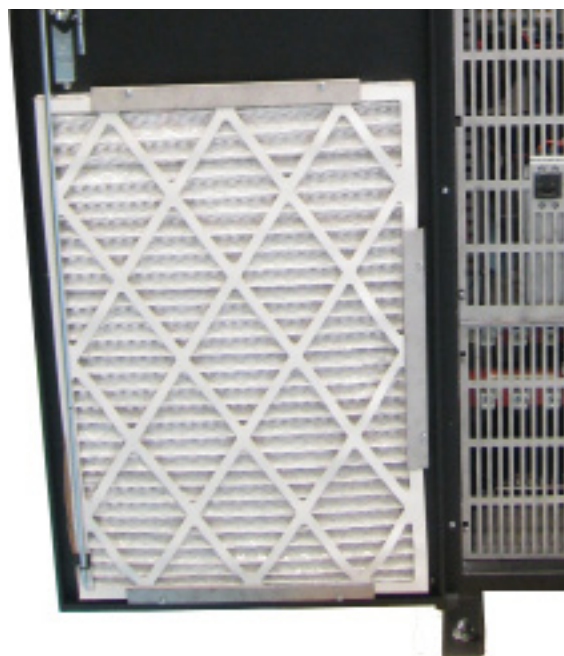
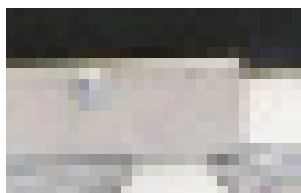

TOSHIBA

TOSHIBA INTERNATIONAL CORPORATION

SOCIAL INFRASTRUCTURE SYSTEMS GROUP

POWER ELECTRONICS DIVISION

13131 West Little York Road, Houston, Texas 77041

Tel (713) 466-0277 Fax. (713) 466-8773

US (800) 231-1412 Canada (800) 872-2192 Mexico 01/800/527-1204

<https://www.toshiba.com/tic/industrial/uninterruptible-power-systems>

Printed in the U.S.A.