

TOSVERT VF-S15 Series

**RS485 Communication Function
Instruction Manual**

TOSHIBA INDUSTRIAL PRODUCTS AND SYSTEMS CORPORATION

NOTICE



1. Read this manual before installing or operating. Keep this instruction manual on hand of the end user, and make use of this manual in maintenance and inspection.
2. All information contained in this manual will be changed without notice. Please contact your Toshiba distributor to confirm the latest information.

Read first

Safety precautions

This manual and labels on the inverter provide very important information that you should bear in mind to use the inverter properly and safely, and also to avoid injury to yourself and other people and damage to property.

Read the safety precautions in the instruction manual for your inverter before reading this manual and strictly follow the safety instructions given.

 CAUTION		Reference
 Mandatory action	<ul style="list-style-type: none"> ◆ Insert an electromagnetic contactor between the inverter and the power supply so that the machine can be stopped without fail from an external controller in case of an emergency. ◆ Do not write the same parameter to the EEPROM more than 10,000 times. The life time of EEPROM is approximately 10,000 times. (Some parameters are not limited, please refer to the “9.Parameter data”) When using the Toshiba inverter protocol and the data does not need to be records, use P command (the data is written only to RAM). ◆ About the handling of the inverter, please follow the Inverter’s instruction manual. 	Inverter’s instruction manual Section 4.2 “Commands”

Contents

1.	General outlines of the communication function.....	3
2.	Data transmission specifications	4
3.	Communication protocol.....	5
3.1.	About the handling of received frames.....	5
4.	Toshiba inverter protocol	6
4.1.	Data transmission format	7
4.1.1.	Data transmission format used in ASCII mode	7
4.1.2.	Data transmission format used in binary mode	10
4.1.3.	Transmission format of Block Communication	13
4.2.	Commands.....	17
4.3.	Transmission errors	20
4.4.	Broadcast communication function	21
4.5.	Examples of the use of communication commands.....	23
5.	Modbus RTU protocol.....	24
5.1.	Modbus RTU transmission format.....	25
5.1.1.	Read command (03H).....	26
5.1.2.	Block Read command : Indirect (03H)	27
5.1.3.	Block Read command : Direct (03H).....	29
5.1.4.	Write command (06H, 10H).....	31
5.1.5.	Block Write command (10H).....	33
5.1.6.	Block Write and Read command (17H)	35
5.1.7.	Identification command (2BH)	37
5.2.	CRC Generation.....	39
5.3.	Error codes.....	40
6.	Inter-drive communication	41
6.1.	Speed proportional control	44
6.2.	Transmission format for inter-drive communication	46
7.	Communication parameters	47
7.1.	Baud rate (<i>F800</i>), Parity (<i>F801</i>).....	49
7.2.	Inverter number (<i>F802</i>)	49
7.3.	Communication time-out detection (<i>F803</i>) (<i>F804</i>) (<i>F808</i>).....	50
7.4.	Communication waiting time (<i>F805</i>)	51
7.5.	Free notes (<i>F880</i>).....	51
7.6.	Communication function reset (<i>F899</i>).....	51
7.7.	Selection of operation command clear (<i>F719</i>).....	51
8.	Commands and monitoring from the computer	52
8.1.	Communication commands (commands from the computer)	52
8.2.	Monitoring from the computer	56
8.3.	Utilizing panel (LEDs and keys) by communication	64
8.3.1.	LED setting by communication	64
8.3.2.	Key utilization by communication.....	67
9.	Parameter data.....	68
	Appendix 1 Table of data codes.....	72
	Appendix 2 Response time	73
	Appendix 3 Inverter capacity code (FB05).....	74
	Appendix 4 Troubleshooting	76
	Appendix 5 Connecting for RS485 communication.....	77

1. General outlines of the communication function

This manual explains the RS485 communications interface function provided for the TOSVERT VF-S15 series of industrial inverters.

The TOSVERT VF-S15 series of inverters can be connected to a computer or a controller (hereinafter referred to as the computer) for data communications via USB converter (USB001Z).

By writing computer programs, you can monitor the operating status of the inverter, control its operation in various ways from the computer, and change and store parameter settings on storage devices.

The communication protocol is preparing the Toshiba inverter protocol and the Modbus RTU protocol. Please choose selection of a protocol with a communication protocol selection parameter (*F B 2 9*).

<Computer link>

By preparing the program (explained later), the following information can be exchanged between the computer and the inverter.

- Monitoring function (used to monitor the operating status of the inverter: Output frequency, current, voltage, etc.)
- Command function (used to issue run, stop and other commands to the inverter)
- Parameter function (used to set parameters and read their settings)

As for data communications codes, the TOSVERT VF-S15 series of inverters support the binary (HEX) code, in addition to the JIS (ASCII) code. The communications function is designed on the assumption that the JIS (ASCII) code is used for communications between the inverter and the personal computer, and the binary (HEX) code for communications between the inverter and the microcomputer built into the controller. A communication number is used to access the desired data item.

* The smallest unit of information that computers handle is called a “bit (binary digit),” which represents the two numbers in the binary system: 1 or 0. A group of 16 bits is referred to as a “word,” which is the basic unit of information the VF-S15 series of inverters use for data communications. One word can handle data items of 0 to FFFFH in hexadecimal notation (or 0 to 65535 in decimal notation).

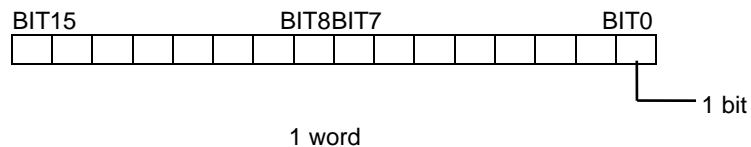

2. Data transmission specifications

Items	Specifications
Transmission scheme	Half-duplex
Synchronization scheme	Start-stop synchronization
Communication baud rate	9600/19200*/38400 bps (selectable using a parameter) *1
Communication protocol	Toshiba inverter protocol * / Modbus RTU protocol (selectable using a parameter) *1
Character transmission	<ASCII mode> JIS X 0201 8-bit (ASCII) <Binary mode, Modbus RTU> Binary codes fixed to 8 bits
Stop bit length	Received by inverter: 1 bit, Sent by inverter: 2 bits *3
Error detecting scheme	Parity *2: Even */Odd/Non parity (selectable using a parameter) *1, checksum(Toshiba inverter protocol), CRC(Modbus RTU protocol)
Character transmission format	11-bit characters *1 (Stop bit=1, with parity)
Order of bit transmission	Least significant bit sent first
Frame length	Variable

*: Standard default setting

*1: Changes to setting do not take effect until the inverter is turned back on or reset.

*2: JIS-X-0201 (ANSI)-compliant 8-bit codes are used for all messages transmitted in ASCII mode and vertical (even) parity bits specified by JIS-X-5001 are added to them. These even parity bits can be changed to odd parity bits by changing the parameter setting (a change to the parameter setting does not take effect until the inverter has been reset.)

*3: The following is the character transmission format.

Characters received: 11 bits (1 start bit + 8 bits + 1 parity bit + 1 stop bit)

START BIT										PARITY BIT	STOP BIT
-----------	--	--	--	--	--	--	--	--	--	------------	----------

The inverter receives **one stop bit**.

(The computer can be set so as to send 1, 1.5 or 2 stop bits.)

Characters sent: 12 bits (1 start bit + 8 bits + 1 parity bit + 2 stop bits)

START BIT										PARITY BIT	STOP BIT	STOP BIT
-----------	--	--	--	--	--	--	--	--	--	------------	----------	----------

The inverter sends **two stop bits**.

(The computer can be set so as to receive 1, 1.5 or 2 stop bits.)

3. Communication protocol

VF-S15 supports the Toshiba inverter protocol and a part of Modbus RTU protocol.

Select the desired protocol from in the following communication protocol selection parameters (*F B 2 9*).

“Parameter Name *F B 2 9*, Communication Number. 0829”

Data Range: 0, 1 (Initial value: 0)

0: Toshiba inverter protocol (Includes inter-drive communication)

1: Modbus RTU protocol

* A parameter change is reflected when the inverter is reset, such as in power off.

3.1. About the handling of received frames

To send and receive data frames, a frame synchronization system for locating the start and end points of each frame is defined with time for which no data is sent (time interval equivalent to the time required to send 3.5 bytes of data).

If no data is sent for the time required to send 3.5 bytes of data at the current transmission speed (approx. 4 ms or more at 9,600 bps or approx. 2 ms or more at 19,200 or approx. 1 ms or more at 38400) after receipt of a frame, the entire frame is assumed to have reached and information in it is analyzed. For this reason, an interval corresponding to at least 3.5 bytes of data must be placed between frames.

When two or more inverters on the same line are controlled individually one after another, the data frames are not only data from the computer to an inverter but also the response from an inverter to the computer. Therefore, an interval corresponding to at least 3.5 bytes should be placed between the time when the computer receives a response from an inverter and the time when it sends a frame to the next inverter. Otherwise the return frame received and the frame that is sent immediately after receipt of the return frame will be recognized as one frame and communication will not be carried out normally.

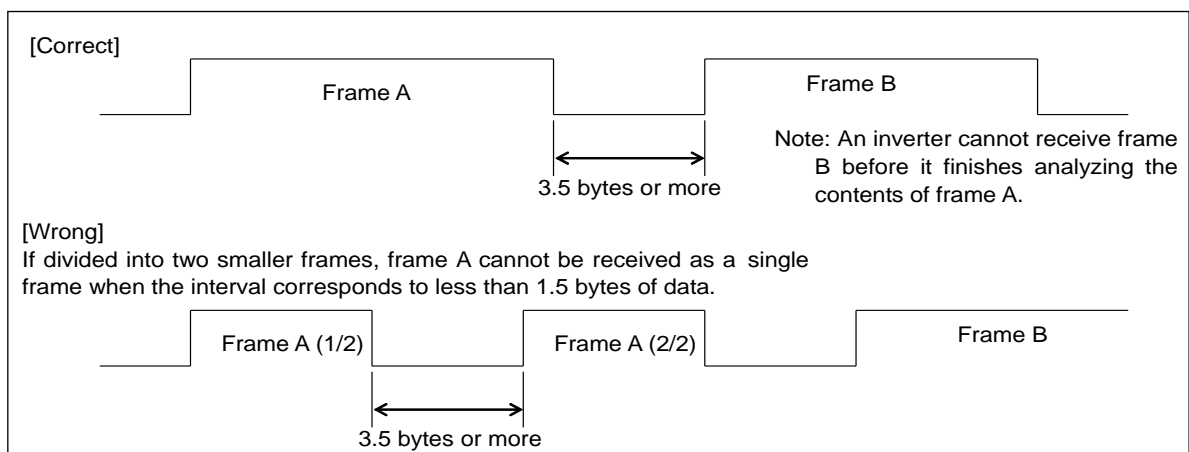

4. Toshiba inverter protocol

Select "TOSHIBA" (F829=0) in the communication protocol selection parameters. "TOSHIBA" (F829=0) is set for initial communication protocol selection of shipment setting. (See "3. Communication protocol".)

- Exchange of data between the computer and the inverter

In communication between the computer and the VF-S15 (hereinafter referred to as the inverter), the inverter is always placed in wait states and acts as a slave that operates on a request from the computer.

The judgment of ASCII mode or binary mode is automatically made with the start code.

	Start code	"CR" (carriage return)
ASCII mode	"("	Required
Binary mode	"2FH(/)"	Not required

- (1) If there is no transmission format or the inverter number that matches, an error occurs and no response is returned.
- (2) When an inverter number is added behind the "(" communication will take place only in case of broadcast communication or if the number matches up with that assigned to the inverters.
- (3) When a time-out period is specified with parameter F803 (communication time-out time), a time-out occurs if communication do not terminate normally within the specified time. With parameter F804 (communication time-out action), you can specify what the inverter should do if a time-out occurs. For details, refer to Section 7.3.
- (4) On executing the command received, the inverter returns data to the computer. For the response time, see Appendix 2, "Response time".

Note:

Communication is not available for about one second (initialization) just after the power is supplied to the inverter. If the control power is shut down due to an instantaneous voltage drop, communication is temporarily interrupted.

4.1. Data transmission format

4.1.1. Data transmission format used in ASCII mode

A communication number is used to specify a data item, all data is written in hexadecimal, and JIS-X-0201 (ASCII (ANSI))-compliant transmission characters are used.

- Computer → Inverter

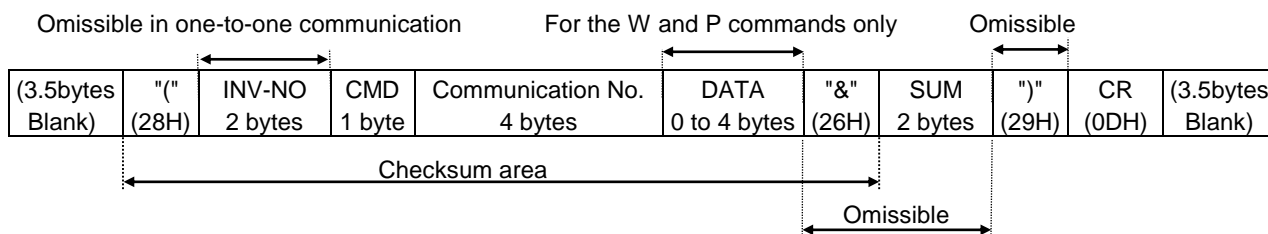

1. "(" (1 byte) : Start code in ASCII mode
2. INV-NO (2 bytes) : Inverter number (Omissible in one-to-one communication) ... 00 (30H, 30H) to 99 (39H, 39h), *(2AH)
The command is executed only when the inverter number matches up with that specified using a parameter.
(When * is specified in broadcast communication, the inverter number is assumed to match if all numbers except * match. When * is specified instead of each digit (two-digit number), all inverters connected are assumed to match.)
If the inverter number does not match or if the inverter number is of one digit, the data will be judged invalid and no data will be returned.
3. CMD (1 byte) : Command (For details, see the table below.)
4. Communication No.(4 bytes)
: Communication number (See "9. Parameter data".)
5. Data (0 to 4 bytes): Write data (valid for the W and P commands only)
6. "&" (1 byte) : Checksum discrimination code (omissible. When omitting this code, you also need to omit the checksum.)
7. Sum (2 bytes) : Checksum (omissible)
Add the ASCII-coded value of the last two digits (4 bits/digit) of the sum of a series of bits (ASCII codes) from the start code to the checksum discrimination code.
Ex.: (R0000&??) CR
 $28H+52H+30H+30H+30H+30H+26H=160H$
The last two digits represent the checksum. = 60
When omitting the checksum, you also need to omit the checksum discrimination code.
8. ")" (1 byte) : Stop code (omissible)
9. CR (1 byte) : Carriage return code

■ Details of commands and data

CMD (1 byte)	Write data (0 to 4 bytes) Hexadecimal number
R (52H): RAM read command	No data
W (57H): RAM/EEPROM write command	Write data (0 to FFFF)
P (50H) RAM write command	Write data (0 to FFFF)

- Inverter → Computer

At time of broadcast communication, returning of data is not executed, except for the inverters to be returned, when the inverter number is not matched, and the inverter number has only one character. This is because there will be a risk of that the returned data may be deformed.

- Data returned when data is processed normally (ASCII mode)

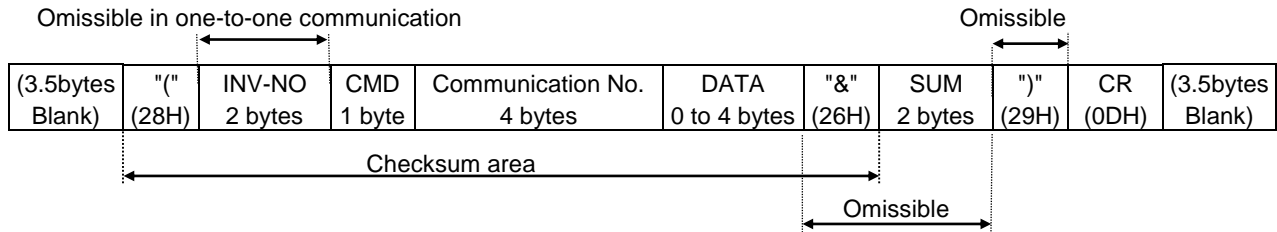

1. "(" (1 byte) : Start code in ASCII mode
2. INV-NO (2 bytes) : Inverter number (omitted if it is not found in the data received) ... 00 (30H, 30H) to 99 (39H, 39H)
If the inverter number matches up with that specified using a parameter, data will be returned to the computer. In broadcast communication, only the destination inverter (with a number matching up with the smallest effective number) returns data to the computer. In broadcast communication, no data is returned from any inverters except the inverter bearing a number that matches up with the smallest effective number.
Ex.: (*2R0000) CR -> (02R00000000) CR
Data is returned from the inverter with the number 2 only, but no data is returned from inverters with the number 12, 22
3. CMD (1 byte) : Command ... The command is also used for a check when an inverter is tripped. When the inverter is normal condition... The uppercase letter R, W or P is returned, depending on the command received: R, W or P command. When the inverter is tripped... The lowercase letter r, w or p is returned, depending on the command received: R, W or P command. (The command received is returned with 20H added to it.)
4. Communication No.(4 bytes) :
The communication number received is returned.
5. Data (0 to 4 bytes): Data ... The data read in is returned for the R command, while the data received is returned for the W and P commands. If the data received is composed of less than 4 digits, it will be converted into 4-digit data and returned.
Ex.: (W123412) CR → (W12340012) CR
6. "&" (1 byte) : Checksum discrimination code (omitted if it is not found in the data received)
7. Sum (2 bytes) : Checksum ... Omitted if no checksum discrimination code is found in the data received. ASCII-coded value of the last two digits (4 bits/digit) of the sum of a series of bits (ASCII codes) from the start code to the checksum discrimination code.
8. ")" (1 byte) : Stop code (omitted if it is not found in the data received)
9. CR (1 byte) : Carriage return code

• Data returned when data is not processed normally (ASCII mode)

In case an error occurs, communication error command (4EH(N) or 6EH(n)) and the error type number is returned to the computer in addition to the checksum. At time of broadcast communication of the binary mode, returning of data is not executed except for the inverter to be returned (inverter number 00H) and when the inverter number is not matched. This is because there will be a risk that the returned data may be deformed.

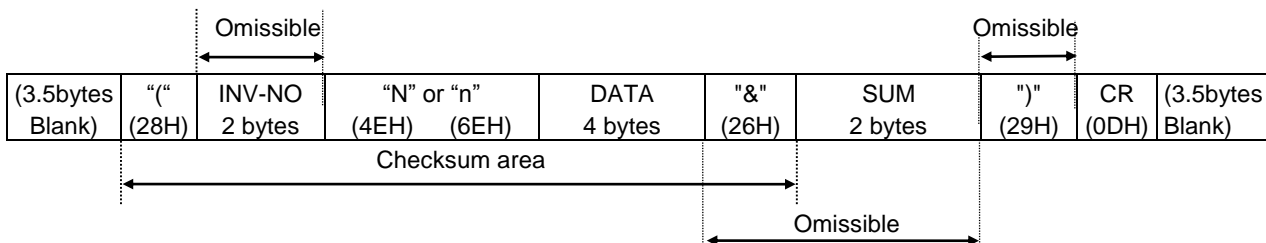

- ““ (1 byte) : Start code in ASCII mode
- “N” or “n” (1 byte) : Communication error command ... This is also used for the checking of inverter trip.
“N” is during normal condition and “n” is during trip.
- INV-NO (2 bytes) : Inverter number (omitted if it is not found in the data received) ... 00 (30H, 30H) to 99 (39H, 39H)
If the inverter number matches up with that specified using a parameter, data will be returned to the computer. In broadcast communication, only the destination inverter (with a number matching up with the smallest effective number) returns data to the computer.
- Data (4 bytes) : Error code (0000~0004)
 - 0000 ... Impossible to execute (Although communication is established normally, the command cannot be executed because it is to write data into a parameter whose setting cannot be changed during operation (e.g., maximum frequency) or the EEPROM is faulty.)
 - 0001 ... Data error (The data is outside the specified range or it is composed of too many digits.)
 - 0002 ... Communication number error (There is no communication number that matches.)
 - 0003 ... Command error (There is no command that matches.)
 - 0004 ... Checksum error (The checksum result differs.)
- ”)” (1 byte) : Stop code ... This code is omitted if it is not found in the data received.

■ Examples:

- (N0000&5C)CR... Impossible to execute (e.g., a change of maximum frequency data during operation)
- (N0001&5D)CR... Data error (Data is outside the specified range.)
- (N0002&5E)CR... No communication number (There is no communication number that matches.)
- (N0003&5F)CR... There is no command that matches. (Commands other than the R, W and P commands)
(Ex.: L, S, a, b, m, r, t, w ...)
- (N0004&60)CR... Checksum error (The checksum result differs.)
- No data returned ... Format error or invalid inverter number

4.1.2. Data transmission format used in binary mode

A communication number is used to specify a data item, data is written in hexadecimal form, and data in transmission characters are represented by binary codes (HEX codes).

- Computer → Inverter (binary mode)

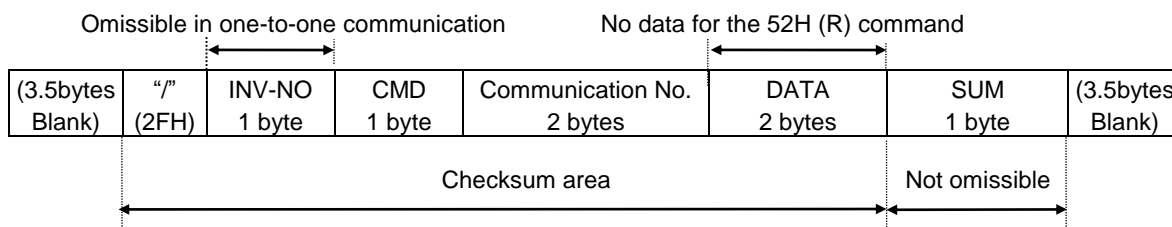

1. 2FH ("f") (1 byte) : Start code in binary mode
2. INV-NO (2 bytes) : Inverter number (Omissible in one-to-one communication) ... 00H to 3FH, FFH
In case the inverter number is other than FFH (broadcast communication), command is executed only when the inverter number coincides with the one designated with the panel. If the inverter number is not matched, it will be judged invalid and the data is not returned.
3. CMD (1 byte) : Command (For details, see the table below.)
52H (R) command: The size of the data following CMD is fixed to 3 bytes. (Communication number: 2 bytes, checksum: 1 byte)
57H (W), 50H (P) and 47H (G) commands: The size of the data following CMD is fixed to 5 bytes.
(Communication number: 2 bytes, data: 2 byte, checksum: 1 byte)
Any command other than the above is rejected and no error code is returned.
4. Communication No.(2 bytes)
: Communication number (See "9. Parameter data".)
5. Data (2 bytes) : 0000H to FFFFH
57H (W) and 50H (P) commands: Write data (An area check is performed.)
47H (G) command: Dummy data (e.g., 0000) is needed.
52H (R) command: Any data is judged invalid. (No data should be added.)
6. Sum (2 bytes) : Checksum (not omissible) 00H to FFH
Value of the last two digits (1 byte) of the sum of a series of bits (codes) from the start code of the data transmitted to the data (or to the communication number for the 52H (R) command)
Ex.: 2F 52 00 ?? ... 2FH+52H+00H+00H=81H
The last two digits (??) represent the checksum= 81

■ Details of commands and data

CMD (1 byte)	Write data (2 bytes) Hexadecimal number
52H (R): RAM read command	No data
57H (W): RAM/EEPROM write command	Write data (0000H to FFFFH)
50H (P): RAM write command	Write data (0000H to FFFFH)
47H (G): RAM read command (for two-wire networks)	Dummy data (0000H to FFFFH)

- Inverter → Computer (binary mode)

At time of broadcast communication of the binary mode, returning of data is not executed except for the inverter to be returned (inverter number 00H) and when the inverter number is not matched. This is because there will be a risk that the returned data may be deformed.

- Data returned when data is processed normally (Binary mode)

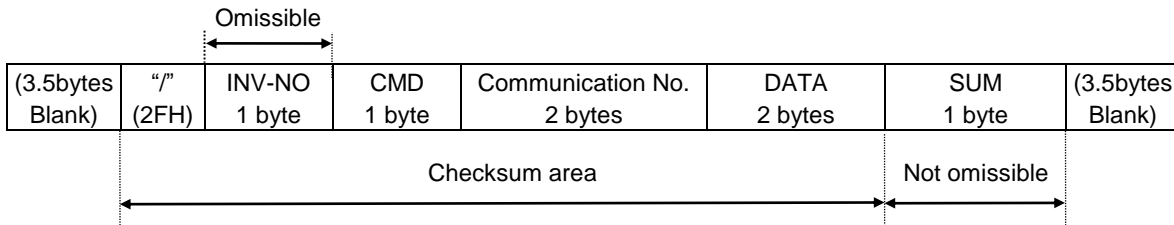

1. 2FH ("f") (1 byte) : Start code in binary mode
2. INV-NO (2 bytes) : Inverter number... 00H to 3FH (The inverter number is omitted if it is not found in the data received.)
If the inverter number matches up with that specified from the operation panel, data will be returned from the inverter. If the inverter number does not match, the data will be invalid and no data will be returned.
3. CMD (1 byte) : Command...The command is also used for a check when the inverter is tripped.
Under normal conditions...52H (R), 47H (G), 57H (W) or 50H (P) is returned, depending on the command received.
When the inverter is tripped...The lowercase letter 72H (r), 67H (g), 77H (w) or 70H (p) is returned with 20H added to it, depending on the command received.
4. Communication No. (4 bytes)
: The communication number received is returned.
5. Data (2 bytes) : Data ... 0000H to FFFFH
The data read is returned for the 52H (R) and 47H (G) commands, while the data written is returned for the 57H (W) and 50H (P) commands.
6. Sum (1 bytes) : Checksum (not omissible) 00H to FFH
Value of the last two digits (1 byte) of the sum of a series of bits (codes) from the start code to the data.

2) Error Processing (Binary mode)

In case an error occurs, communication error command (4EH(N) or 6EH(n)) and the error type number is returned to the computer in addition to the checksum. At time of broadcast communication of the binary mode, returning of data is not executed except for the inverter to be returned (inverter number 00H) and when the inverter number is not matched. This is because there will be a risk that the returned data may be deformed.

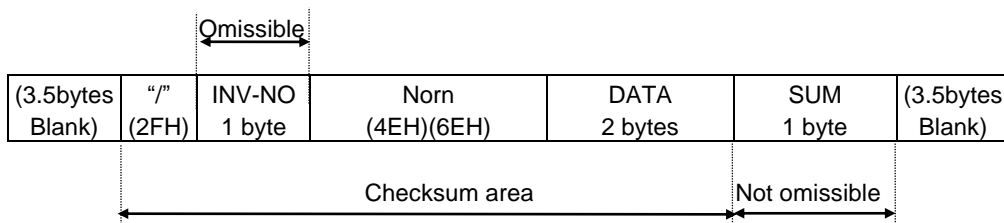

Norn (1 byte) : Communication error command ... This command is also used for a check when the inverter is tripped.
 "4EH (N)" is returned under normal conditions, while "6EH (n)" is returned when the inverter is tripped.

Data (2 bytes) : Error code (0000~0004)
 0000 ... Impossible to execute (Although communication is established normally, the command cannot be executed because it is to write data into a parameter whose setting cannot be changed during operation (e.g., maximum frequency) or the EEPROM is faulty.)
 0001 ... Data error (The data is outside the specified range or it is composed of too many digits.)
 0002 ... Communication number error (There is no communication number that matches.)
 0004 ... Checksum error (The checksum result differs.)

No code returned ...Command error, format error (parity, overrun or framing error) or the inverter number does not match or an inverter in broadcast communication in the binary mode except for the inverter for data returning (the inverter numbered 00H).

■ Examples:

- 2FH, 4EH, 00H, 00H, 7DH ... Impossible to execute (e.g., a change of maximum frequency data during operation)
- 2FH, 4EH, 00H, 01H, 7EH ... Data setting error (The data specified falls outside the specified range.)
- 2FH, 4EH, 00H, 02H, 7FH ... No communication number (There is no communication number that matches.)
- 2FH, 4EH, 00H, 04H, 81H ... Checksum error (The checksum result differs.)

4.1.3. Transmission format of Block Communication

What is block communication?

Data can be written in and read from several data groups set in one communication by setting the type of data desired for communication in the block communication parameters (*F B 7 0*, *F B 7 1*, *F B 7 5* to *F B 7 9*) in advance. Block communication can save the communication time.

Data is transmitted hexadecimal using the binary (HEX) code transmission characters. "Computer → inverter" is for writing only, while "Inverter → computer" for reply is for reading only.

- Computer → Inverter (Block Communication)

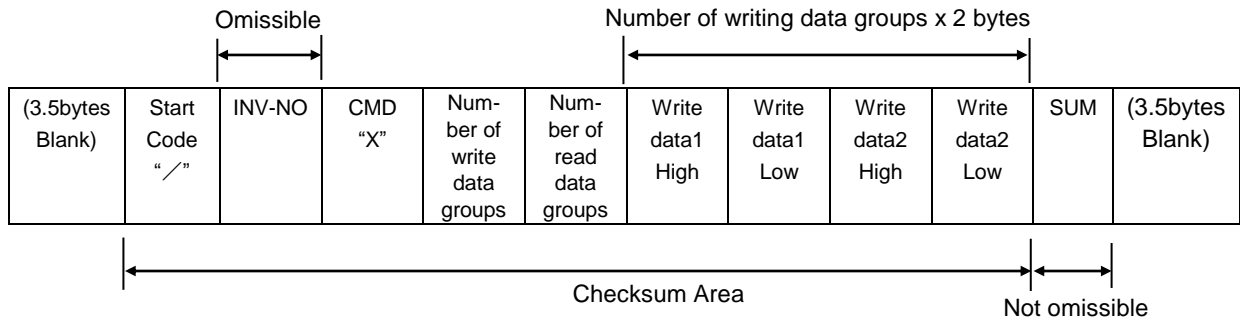

1. 2FH("2FH") (1 byte) : Start code of binary mode
2. INV-NO (1 byte) : Inverter number. (Can be omitted in 1:1 communication): 00H to 3FH, FFH
 Communication performs only when the inverter number is matched. Broadcast communication is FFH.
 Communication data will be invalidated and data will not be returned either if the inverter number does not match.
3. CMD (1 byte) : 'X' (Block communication command)
4. Number of write data groups (1 byte)
 : Specify the number of data groups to be written (00H to 02H).
 If specified outside of the range, data will be treated as a format error and data will not be returned.
5. Number of read data groups (1 byte)
 : Specify the number of data groups to be read (00H to 05H).
 If specified outside of the range, data will be returned as "Number of read data groups = 0" when returned by the inverter.
6. Write data1 (2 bytes)
 : Needed when the number of write data groups is larger than 1.
 The data is written to the specified parameter selected by *F B 7 0*.
 Dummy data is needed if the number of write data groups is larger than 1 even though (none) is selected for *F B 7 0*.
7. Write data2 (2 bytes)
 : Needed when the number of write data groups is 2.
 The data is written to the specified parameter selected by *F B 7 1*.
 Dummy data is needed if the number of write data groups is 2 even though (none) is selected for *F B 7 1*.
8. SUM (1 byte) : Checksum (Cannot be omitted) 00H to FFH
 Lower two digits (1 byte) of total sum from start code (SUM value not included)

■ Block Write 1, 2

Select data, which is desired to be written in block communication, in block write Data 1 and 2 Parameters (*FB70, FB71*). This parameter becomes effective when the system is reset, such as when power is turned off. When the setting is completed, turn off and then on the power.

No.	Block write data	Reference
0	No selection	-
1	Communication command 1 (FA00)	"8.1. Command by communication"
2	Communication command 2 (FA20)	
3	Frequency command value (FA01)	
4	Output data on the terminal board (FA50)	
5	FM analog output (FA51)	
6	Motor speed command (FA13)	

* When "No selection" is specified in the parameters, no data will be written even though write data is specified.

■ Block Read 1 to 5

Select read data, which is desired to be read in block communication, in block read data 1 and 5 Parameters (*FB75 to FB79*). This parameter becomes effective when the system is reset, such as when power is turned off. When the setting is completed, turn off and then on the power.

No.	Block read data	Reference
0	No selection	-
1	Status information 1 (FD01)	"8.2. Monitoring from communication"
2	Output frequency (FD00)	
3	Output current (FD03)	
4	Output voltage (FD05)	"9. Parameter data"
5	Alarm information 1 (FC91)	"8.2. Monitoring from communication"
6	PID feedback value (FD22)	"9. Parameter data"
7	Input terminal monitor (FD06)	"8.2. Monitoring from communication"
8	Output terminal monitor (FD07)	
9	Terminal VIA monitor (FE35)	
10	Terminal VIB monitor (FE36)	
11	Terminal VIC monitor (FE37)	
12	Input voltage (FD04)	
13	Motor speed (FE90)	
14	Torque (FD18)	

* "0000" will be returned as dummy data, if "0 (No selection)" is selected for the parameter and "read" is specified.

• Inverter → Computer

At time of broadcast communication of the binary mode, returning of data is not executed except for the inverter to be returned (inverter number 00H) and when the inverter number is not matched. This is because there will be a risk that the returned data may be deformed.

1) Normal processing

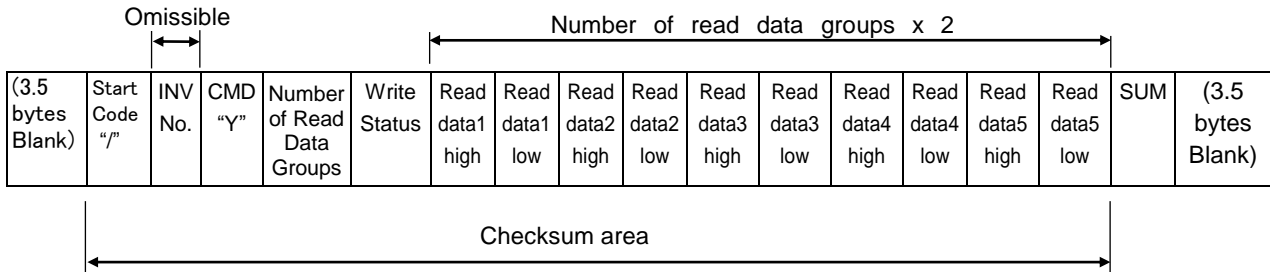

- 1. 2FH "r" (1 byte) : Start code in binary mode
- 2. INV-NO (1Byte) : Inverter number ···00H to 3FH
 If the inverter number matches up with that specified from the operation panel, data will be returned from the inverter. If the inverter number does not match, the data will be judged invalid and no data will be returned. Communication data will be invalidated and data will not be returned either if the inverter number does not match. (Inverter number is considered matched if it is omitted during reception)
- 3. CMD(1Byte) : 'Y' (Block communication command [monitoring])
 Lowercase letter 'y' is during inverter trip or inverter retry.
- 4. Number of read data groups (1 byte) : Return the number of data groups to be read (00H to 05H).
- 5. Write status (1 byte) : Return 00H to 03H.
 * Failing to write in the specified parameter in the number of write data groups, set "1" in the corresponding bit for the parameter failed to write. (See below.)

Bit Position	7	6	5	4	3	2	1	0
Data Type	-						FB77	FB70

- 6. Read data1 - 5 (2 bytes) : Return according to the number of read data groups. "0000H" is returned as dummy data if "0" is selected as a parameter.
 Read data1: Data selected by FB75. Read data2: Data selected by FB76.
 Read data3: Data selected by FB77. Read data4: Data selected by FB78.
 Read data5: Data selected by FB79.
- 7. SUM(1Byte) : Checksum (Cannot be omitted) 00H to FFH
 Lower two digits (1 byte) of total sum from start code of return data to read data.

■ Example

(When set as follows: FB70 = 1 (Communication command 1), FB71 = 3 (Frequency command value), FB75 = 1 (Status information 1), FB76 = 2 (Output frequency), FB77 = 3 (Output current), FB78 = 4 (Output voltage) and FB79 = 5 (Alarm information))

Computer → Inverter : 2F 58 02 05 C4 00 17 70 D9

Inverter → Computer : 2F 59 05 03 00 00 00 00 00 00 00 00 00 00 90 (When parameter is not set)

Inverter → Computer : 2F 59 05 00 40 00 00 00 00 00 00 00 00 00 CD CD (When parameter is set)

Inverter → Computer : 2F 59 05 00 64 00 17 70 1A 8A 24 FD 00 00 3D (During operation at 60Hz)

2) Error Processing (Binary mode)

In case an error occurs, communication error command (4EH(N) or 6EH(n)) and the error type number is returned to the computer in addition to the checksum.

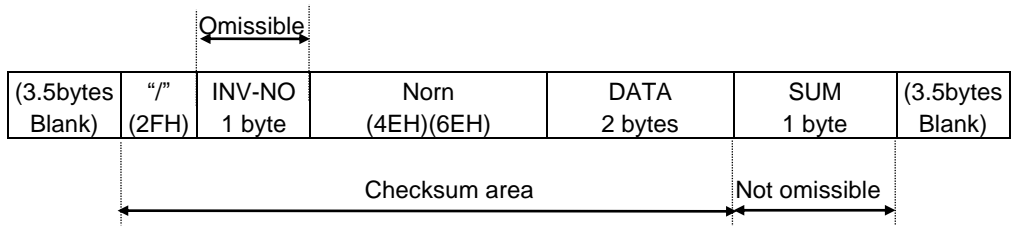

"N" or "n" (1 byte) : Communication error command. Also for check during an inverter trip (includes standing by for retrying and trip holding). "4EH (N)" is during normal condition, "6EH (n)" is during trip.

DATA (2 bytes) : Error code (0004)
 0004 : Checksum error (The checksum does not match)
 No return : Command error, format error (parity error, overrun error or framing error), inverter number mismatch, and inverter number other than 00H in broadcast communication.

■ Examples

Computer → Inverter : 2F 58 02 05 C4 00 17 70 D8

Inverter → Computer : 2F 4E 00 04 81 ... Checksum error

4.2. Commands

Here are the communication commands available.

Command	Function
W command	Writes the data with the specified communication number. (RAM and EEPROM).
P command	Writes the data with the specified communication number. (RAM).
R command	Reads the data with the specified communication number.
G command	Reads the data with the specified communication number. (For binary mode only. Dummy data is required for this command.)
S command	Inter-drive communication command (For binary mode only.)
X command	Block communication (Computer -> Inverter)
Y command	Block communication (Inverter -> Computer)

■ **W (57H)** (RAM^{*1}/EEPROM^{*2} write)

This command is used to write new data into the parameter specified using its communication number. It writes data into the RAM and EEPROM. For parameters whose settings cannot be stored in the EEPROM (e.g., parameter with the communication number FA00), the W (57H) command writes data into the RAM only. It cannot be used to write data into read-only parameters (e.g., parameter with the communication number FD?? or FE??).

Each time an attempt to write data is made, the inverter checks if the data falls within the specified range. If this check reveals that the data falls outside the specified range, the inverter will reject it and return an error code.

- Ex.: Setting the deceleration time (communication number: 0010) to 10 sec.

<ASCII mode>

Computer → Inverter Inverter → Computer
(W00100064)CR (W00100064)CR ... (10÷0.1=100=0064H)

CR: Carriage return

<Binary mode>

Computer → Inverter Inverter → Computer
2F 57 00 10 00 64 FA 2F 57 00 10 00 64 FA ... (10÷0.1=100=0064H)

⚠ CAUTION	
 Mandatory action	<p>◆ Do not write the same parameter to the EEPROM more than 10,000 times. The life time of EEPROM is approximately 10,000 times. (Some parameters are not limited, please refer to the "9. Parameter data")</p> <p>The lifetime of EEPROM is approximately 10,000 times. When using the Toshiba inverter protocol and the data does not need to be records, use P command (the data is written only to RAM).</p>

• Explanation of terms

*1: The RAM is used to temporarily store inverter operation data. Data stored in the RAM is cleared when the inverter is turned off, and data stored in the EEPROM is copied to the RAM when the inverter is turned back on.

*2: The EEPROM is used to store inverter operation parameter settings, and so on. Data stored in the EEPROM is retained even after the power is turned off, and it is copied to the RAM when the inverter is turned on or reset.

■ P (50H) (RAM¹ write)

This command is used to rewrite data into the parameter specified using a communication number. It writes data into the RAM only. It cannot be used to write data into any read-only parameters. Each time an attempt to write data is made the inverter checks whether the data falls within the specified range. If this check reveals that the data falls outside the range, the inverter will reject it and return an error code.

- Ex.: Entering the emergency stop command (communication number: FA00) from the computer
<ASCII mode>

<u>Computer → Inverter</u>	<u>Inverter → Computer</u>	
(PFA009000)CR	(PFA009000)CR	...Command priority, emergency stop command

<Binary mode>

<u>Computer → Inverter</u>	<u>Inverter → Computer</u>
2F 50 FA 00 90 00 09	2F 50 FA 00 90 00 09

■ R (52H) (Data read)

This command is used to read the setting of the parameter specified using a communication number.

- Ex.: Monitoring the electric current (communication number: FE03)

<ASCII mode>

<u>Computer → Inverter</u>	<u>Inverter → Computer</u>	
(RFE03)CR	(RFE03077B)CR	...Current: 1915 / 100 = 19.15%

<Binary mode>

<u>Computer → Inverter</u>	<u>Inverter → Computer</u>
2F 52 FE 03 82	2F 52 FE 03 07 7B 04

■ G (47H) (Data read)

This command is used to read the parameter data specified using a communication number. Although this command is used for the previous model to control the operation of two or more inverters in binary mode through two-wire RS485 network, the "R" command can also be used without problems for the VF-S15 series.

To use the "G" command, however, dummy data (2 bytes) is needed.

This command is available only in binary mode.

- Ex.: Monitoring the electric current (communication number: FE03)

<u>Computer → Inverter</u>	<u>Inverter → Computer</u>
2F 47 FE 03 00 00 77	2F 47 FE 03 07 7B F9

* In this example, the data 00H sent from the computer to the inverter is dummy data.

■ S (53H)/ s (73H) Inter-drive communication command(RAM¹ Write)

This command is for using frequency command value in % (1 = 0.01%), instead of in Hz, and is for synchronous-proportional operation in inter-drive communication. This command can also be used in ordinary computer link communications.

When writing in the frequency command value (FA01) is enabled and a parameter other than it is specified, a communication number error will result. Data is written in the RAMs only.

Data is not returned from the inverters while this command is used. This command can be used only in the binary mode.

For the details of the format, see "6.2. Transmission format for inter-drive communication".

Use (%) as the unit for frequency command value specified by the command S, instead of (Hz), and the receiving side converts units for frequency values to "Hz" in accordance with the point conversion parameter. The conversion formula is shown below.

Frequency command value (Hz) =

$$\frac{\text{Point 2 frequency (F814)} - \text{Point 1 frequency (F812)}}{\text{Point 2 (F813)} - \text{Point 1 (F811)}} \times (\text{Frequency command value (\%)}) - \text{Point 1 (F811)} + \text{Point 1 frequency (F812)}$$

When Command "s" (lowercase letter) is received, the slave side judges that the master side is tripped and operates in accordance with the inter-drive communication parameter (*F805*).
For detail, see "7. Communication parameters".

- Examples: 50% frequency command
(If maximum frequency = Frequency for operation at 80Hz = 40Hz: 50% = 5000d = 1388H)

<Binary mode>

Master inverter → Slave inverter
2F 53 FA 01 13 88 18

Slave inverter → Master inverter
No return

■ X(58H)/Y (59H) (Block Communication Command)

Data selected in the block communication write parameters (*F870*, *F871*) is written in the RAM. When returning data, data selected in block communication read parameters (*F875* to *F879*) is read and is returned.

For detail, see "4.1.3. Transmission format of Block Communication".

- Examples: 60Hz operation command from communication and monitoring (Monitoring when already operating at 60Hz)
(Parameter Setting: *F870* = 1, *F871* = 3, *F875* = 1, *F876* = 2, *F877* = 3, *F878* = 4, *F879* = 5)

<Binary mode>

Computer → Inverter
2F 58 02 05 C4 00 17 70 D9

Inverter → Computer
2F 59 05 00 64 00 17 70 1A 8A 24 FD 00 00 3D

4.3. Transmission errors

- Table of error codes

Error name	Description	Error code
Impossible to execute	The command is impossible to execute, though communication was established normally. 1 Writing data into a parameter whose setting cannot be changed during operation (e.g., maximum frequency) *1 2 Writing data into a parameter while “ <i>!n !t</i> ” is in progress 3 <i>F 700</i> (Parameter protection selection) is <i>2</i> : Writing prohibited (1+RS485 communication), <i>4</i> : Reading prohibited (3+RS485 communication) 4 If <i>F 738</i> (Password setting) was set to data, <i>F 738</i> can not set to data	0000
Data error	Invalid data is specified.	0001
Communication number error	There is no communication number that matches.	0002
Command error	The command specified does not exist.	0003 (ASCII mode) No code returned (Binary mode)
Checksum error	The checksum does not match.	0004
Format error	The data transmission format does not match. 1 One-digit inverter number (ASCII mode) 2 The CR code is found in the designated position. (ASCII mode) Ex.:Communication number of 4 digits or less. In the case of (R11) CR, 11) CR is recognized as a communication number and the CR code is not recognized, with the result that a format error occurs. 3 A code other than the stop code (“”) is entered in the stop code position.	No code returned
Receiving error	A parity, overrun or framing error has occurred. *2	No code returned

*1: For parameters whose settings cannot changed during operation, see the inverter’s instruction manual.

*2: Parity error : The parity does not match.
 Overrun error : A new data item is entered while the data is being read.
 Framing error : The stop bit is placed in the wrong position.

* For the errors with “no code returned” in the above table, no error code is returned to avoid a data crash.
 If no response is received, the computer side recognizes that a communication error has occurred. Retry after a lapse of some time.

* If the inverter number does not match, no processing will be carried out and no data will be returned, though it is not regarded as an error.

4.4. Broadcast communication function

Broadcast communication function can transmit the command (write the data) to multiple inverters by one communication. Only the write (W, P) command is valid and the read (R, G) command is invalid. The inverters subject to the broadcast communication are the same to the independent communication; 0 to 99 (00H - 63H) in the ASCII mode, and 0 to 63 (00H - 3FH) in the binary mode. To avoid data deforming, the inverters to return data will be limited.

- "Overall" broadcast communication (ASCII mode / Binary mode)

- ASCII Mode

If you enter two asterisks (**) in the inverter number position of the data transmission format, the computer will send the data simultaneously to all inverters (with an inverter number between 0 and 99 (00 to 63H)) on the network.

- Binary Mode

To put "FF" to the specified place of the inverter number in the communication format validates the broadcast communication and the command is transmitted to all the applicable inverters in the network (inverter numbers from 0 to 63 (00 to 3FH)).

<Inverter that returns data to the computer>

Data is returned from the inverter bearing the inverter number 00 only.

If you do not want inverters to return data, do not assign the number 00 to any inverter on the network.

- "Group" broadcast communication (ASCII mode only)

If you put "*" in the inverter number position of the data transmission format, data will be sent simultaneously to all inverters bearing a number whose digit in the one's place in decimal notation is "*".

If you put "?*" in the inverter number position of the data transmission format, the data will be sent simultaneously to all inverters bearing a number whose digit in the ten's place in decimal notation is "*".

("?": Any number between 0 and 9.)

<Inverter that returns data to the computer>

Data is returned only from the inverter bearing the smallest number in the same group of inverters (i.e., inverter whose number in the position of "*" is 0).

If you do not want inverters to return data to the computer, do not assign a number having a 0 in the position of "*" to any inverter on the network.)

- Examples of broadcast communication

Ex: Set the frequency setting for communication to 60Hz.

- 1 Computer → Multiple inverters: broadcast communication (ASCII Mode)

Example of transmission of data from computer to inverter: (**PFA011770)_{CR}

Example of data returned from inverter to computer: (00PFA011770)_{CR}

Data is returned from the inverter numbered 00 only, while commands are issued to all inverters connected to the network.

- 2 Computer → A specific group of inverters: group communication (ASCII Mode)

Example of transmission of data from computer to inverters: (*9PFA011770)_{CR}

Example of data returned from inverter to computer: (09PFA011770)_{CR}

Data is returned only the inverter numbered 09 only, while commands are issued to a maximum of 10 inverters bearing the number 09, 19, 29, 39, ... or 99.

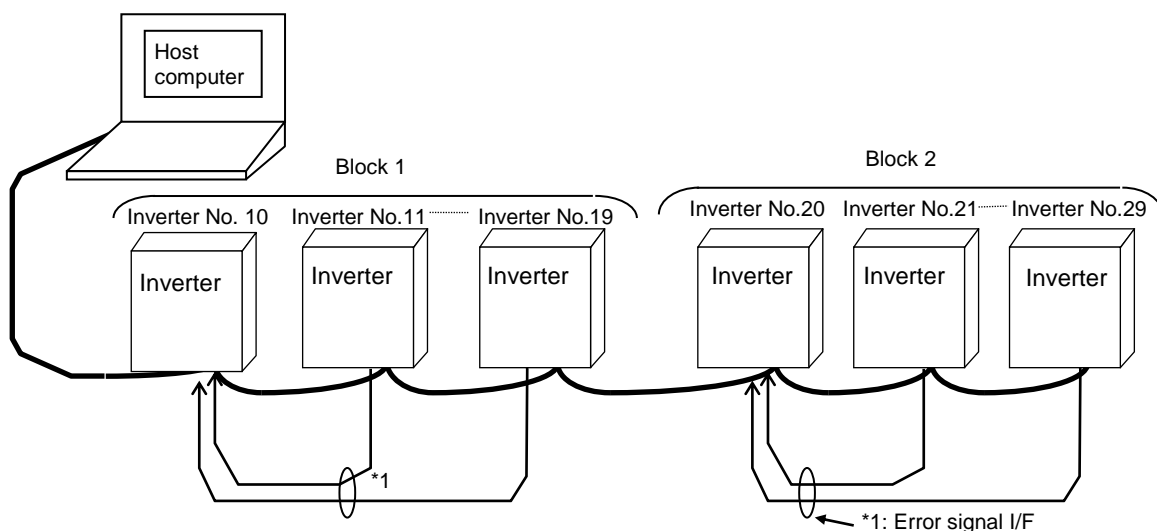

In broadcast communication, only the representative inverter in each block returns data to the computer. However, you can make the representative inverter in each block report the occurrence of a problem in the block. To do so, follow these steps.

Set the timer function so that, if a time-out occurs, the inverter will trip (Ex.: $F803=3$ (sec)), set the output terminal selection parameter (FL) so that trip information will be output through the output terminal ($F132=10$), and set the input terminal selection parameter (F) of the representative inverter in each block to "external input trip (emergency stop)" ($F111=20, 21$ (Inversion)). Then, connect the input terminal (F, CC) of the representative inverter to the FL terminal (FLA, FLC) of each of the other inverters in the same block. In this setting, if an inverter trips, the representative inverter will come to an emergency stop, and as a result it will report the occurrence of a problem in its block to the computer. (If the representative inverter returns a lowercase letter in response to a command from the computer, the computer will judge that a problem has arisen in an inverter.) To examine details on the problem that has arisen, the computer accesses each individual inverter, specifying its communication number. To make the computer issue a command to all inverters in block 1 or block 2 shown in the figure above, specify "1*" or "2*", respectively. In this system, inverter No. 10 will return data to the computer if a problem arises in block 1, or inverter No. 20 if a problem arises in block 2. For overall broadcast communication, specify "***", in which case the inverter with the communication number "00" will return data to the computer.

In this example, if you want the computer to maintain communication without bringing a representative inverter to an emergency stop, set its input terminal selection parameter to "disabled" ($F111=0$) but not to "external input trip (emergency stop)." This setting causes the computer to check the setting of the input terminal information parameter (Communication No.=FE06, bit 0) of the representative inverter, and as a result enables the computer to detect the occurrence of a problem.

CAUTION:

Data from inverters will be deformed if inverters of the same number are connected on the network. Never assign same single numbers to inverters on the network.

4.5. Examples of the use of communication commands

Here are some examples of the use of communication commands provided for the VF-S15 series of inverters.

Inverter numbers and checksum used in ASCII mode are omitted from these examples.

■ Examples of communication

- To run the motor in forward direction with the frequency set to 60 Hz from the computer

<ASCII mode>

<u>Computer → Inverter</u>	<u>Inverter → Computer</u>	
(PFA011770)CR	(PFA011770)CR	...Set the operation frequency to 60 Hz. (60 / 0.01 Hz = 6000 = 1770H)
(PFA00C400)CR	(PFA00C400)CR	...Set to "forward run" with commands and frequency instruction from the computer enabled.

<Binary mode>

<u>Computer → Inverter</u>	<u>Inverter → Computer</u>
2F 50 FA 01 17 70 01	2F 50 FA 01 17 70 01
2F 50 FA 00 C4 00 3D	2F 50 FA 00 C4 00 3D

- To monitor the output frequency (during 60 Hz operation)

<ASCII mode>

<u>Computer → Inverter</u>	<u>Inverter → Computer</u>	
(RFD00)CR	(RFD001770)CR	...Set the operation frequency to 60 Hz. (60÷0.01Hz=6000=1770H)

<Binary mode>

<u>Computer → Inverter</u>	<u>Inverter → Computer</u>
2F 52 FD 00 7E	2F 52 FD 00 17 70 05

- To monitor the status of the inverter

<ASCII mode>

<u>Computer → Inverter</u>	<u>Inverter → Computer</u>	
(RFD01)CR	(rFD010003)CR	...For details on statuses, see "8.2. Monitoring from the computer". (Stop status, FL output status, trip status (r command))

<Binary mode>

<u>Computer → Inverter</u>	<u>Inverter → Computer</u>
2F 52 FD 01 7F	2F 72 FD 01 00 03 A2

- To check the trip code (when the inverter is tripped because of $\overline{E} r r \overline{5}$)

...For details on trip codes, see "Trip code monitor" in "8.2. Monitoring from the computer". (18H = 24d " $\overline{E} r r \overline{5}$ " trip status)

<ASCII mode>

<u>Computer → Inverter</u>	<u>Inverter → Computer</u>
(RFC90)CR	(rFC900018)CR

<Binary mode>

<u>Computer → Inverter</u>	<u>Inverter → Computer</u>
2F 52 FC 90 0D	2F 72 FC 90 00 18 45

5. Modbus RTU protocol

The Modbus RTU protocol of VF-S15 supports only part of the Modbus RTU protocol. All data will be binary codes.

• Parameter Setting

• Protocol selection (F829)

Select "Modbus RTU (F829 = 1) in the communication selection parameters. "TOSHIBA" (F829=0) is set for communication protocol selection in initial shipment setting. (See "3. Communication protocol".)

• Inverter number (F802)

Inverter numbers. 0 to 247 can be specified in the Modbus RTU. "0" is allocated to broadcast communication (no return). Set between 1 and 247.

<Related Parameter: Change and set as necessary>

F800 : Baud rate

F801 : Parity

• Data Exchange with Inverters

The inverters are always ready to receive messages and perform slave operation in response to computer requests.

A transmission error will result if the transmission format does not match. The inverters will not respond if a framing error, parity error, CRC error or an inverter number mismatch occurs. If no response is received, the computer side recognizes that a communication error has occurred. Transmit data again.

(1) In case spacing for more than 3.5 bytes are provided before characters, all data immediately preceding it will be aborted. (See "3.1. About the handling of received frames".)

(2) Communication will be effective only when inverter numbers match or the communication mode is 0 (Broadcast communication). If there is no inverter number that matches or 0 (broadcast communication) is specified, no response is returned by any inverter.

(3) If no communication take place within the time specified using the timer function, the computer will assume that a communication error has occurred and trip the inverter. The timer function is disabled when the inverter is turned on or initialized. For details, see "7.3. Communication time-out detection".

(4) On executing the command received, the inverter returns data to the computer. For the response time, see Appendix 2, "Response time".

■ Caution:

Communication is not possible for about one second after the power is supplied to the inverter until the initial setting is completed. If the control power is shut down due to an instantaneous voltage drop, communication is temporarily interrupted.

5.1.Modbus RTU transmission format

Modbus RTU sends and receives binary data without a frame-synchronizing start code and defines the blank time to recognize the start of a frame. Modbus RTU decides the data that is first received subsequently as the first byte of a frame after a blank time for 3.5 bytes at the on-going communication speed.

【Request format / Positive response】

(3.5bytes Blank)	Inverter No.	Command	Data	CRC16		(3.5bytes Blank)
				low	high	
	1byte	1byte	variable length	1byte	1byte	

1) Inverter No. (1 byte) : Specify an inverter number between 0 and 247 (00H to F7H).
 Command processing will be executed only broadcast communication “0” and with those inverters that match set inverter numbers. Data will not be returned if “0” (broadcast communication) and inverter numbers do not match. Don’t use the number between 248 and 255(F8H to FFH) for inverter option and shipment test.

2) Command (1 byte) : Set the command. Refer to section 5.1.7 from 5.1.1

Command		Function	Information	Reference
Decimal	Hex			
03	03H	Read	Read the data with the specified communication number.	5.1.1
		Block read	Block read communication (Indirect)	5.1.2
			Block read communication (Direct)	5.1.3
06	06H	Write	Write the data with the specified communication number. (RAM and EEPROM).	5.1.4.1
16	10H			5.1.4.2
16	10H			Block write
23	17H	Block write and read	Block write and read communication (Indirect)	5.1.6
43	2BH	Identification	Reads the Inverter information (manufacture , type format , software version)	5.1.7

3) Data (variable length) : Set the data requested by command.

4) CRC (2 bytes) : Set generation results of CRC in the order of low to high numbers. For the method to generate CRC, see “5.2. CRC Generation”. Note that the setting sequence is reversal to that of others.

【Negative response】

(3.5bytes Blank)	Inverter No.	Command	Error code	CRC16		(3.5bytes Blank)
				low	high	
	1byte	Requested command + 80H	See “5.3. Error codes”.	1byte	1byte	

5.1.1. Read command (03H)

- Computer → Inverter *The text size is 8 bytes fixed.

Inverter No.	Command	Communication No.		Number of Data Groups		CRC16	
		high	low	high	low	low	high
	03			00	01		

- 1) Inverter No. (1 byte) : ---
- 2) Command (1 byte) : Set the read command (03H fixed).
- 3) Communication No. (2 bytes) : Set in the order of high to low numbers.
- 4) Number of data groups (2 bytes) : Set the number of data words 0001 (fixed) in the order of high to low numbers.
- 5) CRC16 (2 bytes) : ---

- Inverter → Computer (Normal return) *The text size is 7 bytes fixed.

Inverter No.	Command	Number of Data	Read data		CRC16	
			high	low	low	high
	03	02				

- 1) Inverter No. (1 byte) : ---
- 2) Command (1 byte) : Read command (03H fixed) will be returned.
- 3) Number of data : A number of data bytes (02H fixed) will be returned.
The number of data groups for transmission to the inverters is 2 bytes and 01H fixed.
- 4) Read data (2 bytes) : Returned in the order of read data (high) and (low).
- 5) CRC16 (2 bytes) : ---

- Inverter → Computer (Abnormal return) *The text size is 5 bytes fixed.

Inverter No.	Command	Error Code	CRC16	
			low	high
	83			

- 1) Inverter No (1 byte) : ---
- 2) Command (1 byte) : 83H fixed (Read command error) (Command + 80H)
- 3) Error code (1 byte) : See "5.3. Error codes".
- 4) CRC16 (2 bytes) : ---

■ Example: Reading output frequency (During 60Hz operation)

(Computer → Inverter) 01 03 FD 00 00 01 B5 A6
(Inverter → Computer) 01 03 02 17 70 B6 50

■ Example: Data specification error

(Computer → Inverter) 01 03 FD 00 00 02 F5 A7
(Inverter → Computer) 01 83 03 01 31

5.1.2. Block Read command : Indirect (03H)

Select the read data which is desired to be read in block communication to Block Communication Read Data Parameters (F875 to F879). This parameter becomes effective when the system is reset, such as when power is turned off. When the setting is completed, turn off and then on the power.

No.	Block read data	Reference
0	No selection	-
1	Status information 1 (FD01)	"8.2. Monitoring from communication"
2	Output frequency (FD00)	
3	Output current (FD03)	
4	Output voltage (FD05)	"9. Parameter data"
5	Alarm information 1 (FC91)	"8.2. Monitoring from communication"
6	PID feedback value (FD22)	"9. Parameter data"
7	Input terminal monitor (FD06)	"8.2. Monitoring from communication"
8	Output terminal monitor (FD07)	
9	Terminal VIA monitor (FE35)	
10	Terminal VIB monitor (FE36)	
11	Terminal VIC monitor (FE37)	
12	Input voltage (FD04)	
13	Motor speed (FE90)	
14	Torque (FD18)	

* "0000" will be returned as dummy data, if "0 (No selection)" is selected for the parameter and "read" is specified.

- Computer → Inverter *The text size is 8 bytes fixed.

Inverter No.	Command	Communication No.		Number of Data Groups		CRC16	
		high	low	high	low	low	high
	03	18	75	00	02-05		

- 1) Inverter No. (1 byte) : ---
- 2) Command (1 byte) : Set the read command (03H fixed).
- 3) Communication No. (2 bytes) : Set in the order of high to low numbers (1875H fixed).
- 4) Number of data groups (2 bytes) : Set the number of data words from 0002H to 0005H.
- 5) CRC16 (2 bytes) : ---

- Inverter → Computer *The text size is variable.

Inverter No.	Command	Number of data	Read data 1		...	Read data 5		CRC16	
			high	low		high	low	low	high
	03	04-10							

- 1) Inverter No. (1 byte) : ---
- 2) Command (1 byte) : Set the read command (03H fixed).
- 3) Number of data (1 bytes) : The number of read data bytes will be returned. The number is from 04H to 0AH bytes. Note that the number of byte is variable.
- 4) Read data 1 (2 bytes) : The data selected with F875 is read.
- 5) Read data 2 (2 bytes) : The data selected with F876 is read.
- 6) Read data 3 (2 bytes) : The data selected with F877 is read.

- 7) Read data 4 (2 bytes) : The data selected with *F878* is read.
- 8) Read data 5 (2 bytes) : The data selected with *F879* is read.
- 9) CRC16 (2 bytes) : ---

• Inverter → Computer (Abnormal return) *The text size is 5 bytes fixed.

Inverter No.	Command	Error Code	CRC16	
			low	high
	83			

- 1) Inverter No (1 byte) : ---
- 2) Command (1 byte) : 83H fixed (Read command error) (Command + 80H)
- 3) Error code (1 byte) : See "5.3. Error codes".
- 4) CRC16 (2 bytes) : ---

■ Example: Indirect block read of 5 words(During 60Hz operation)

< Parameter >

- F802* (Inverter number) = *1*
- F829* (Selection of communication protocol) = *1*: Modbus RTU
- F875* (Block read data 1) = *1*: Status information 1
- F876* (Block read data 2) = *2*: Output frequency
- F877* (Block read data 3) = *3*: Output current
- F878* (Block read data 4) = *4*: Output voltage
- F879* (Block read data 5) = *5*: Alarm information

(Computer → Inverter) 01 03 18 75 00 05 92 B3
 (Inverter → Computer) 01 03 0A E4 04 17 70 00 00 26 FF 00 80 58 00

■ Example: Indirect block read of 2 words(During 60Hz operation and *F875=1, F876=2*)

(Computer → Inverter) 01 03 18 75 00 02 D3 71
 (Inverter → Computer) 01 03 04 E4 04 17 70 83 16

■ Example: Indirect block read of 2 words(During 60Hz operation and *F875=0, F876=2*)

(Computer → Inverter) 01 03 18 75 00 02 D3 71
 (Inverter → Computer) 01 03 04 00 00 17 70 F4 27

■ Example: Data error (Number of word is wrong)

(Computer → Inverter) 01 03 18 75 00 06 D2 B2
 (Inverter → Computer) 01 83 03 01 31

■ Example: Data error (Communication number is wrong)

(Computer → Inverter) 01 03 18 76 00 02 23 71
 (Inverter → Computer) 01 83 03 01 31

5.1.3. Block Read command : Direct (03H)

The data of consecutive communication number from the specified communication number is read. Eight data or less is read.

Communication numbers "xxxAH" to "xxxFH" and "xxAxH" to "xxFxH" don't exist in VF-S15.

Therefore, these communication numbers are automatically skipped when read by Block Read command:Direct (03H) in Modbus RTU protocol.

For example:

When the data of two words is read from ACC (0009h), 000Ah doesn't exist because of this specification. Consequently, in this case ACC(0009h) and DEC(0010h) are read.

When a consecutive communication number doesn't exist, the data of 8000H is sent back.

- Computer → Inverter *The text size is 8 bytes fixed.

Inverter No.	Command	Communication No.		Number of Data Groups		CRC16	
		high	low	high	low	low	high
	03			00	02-08		

- 1) Inverter No. (1 byte) : ---
- 2) Command (1 byte) : Set the read command (03H fixed).
- 3) Communication No. (2 bytes) : Set in the order of high to low numbers.
Note: If communication number doesn't exist, return the error to computer.
- 4) Number of data groups (2 bytes) : Set the number of data words from 0002H to 0008H.
- 5) CRC16 (2 bytes) : ---

- Inverter → Computer *The text size is variable.

Inverter No.	Command	Number of data	Read data 1		...	Read data 8		CRC16	
			high	low		high	low	low	high
	03	04-16							

- 1) Inverter No. (1 byte) : ---
- 2) Command (1 byte) : Set the read command (03H fixed).
- 3) Number of data (1 bytes) : A number of data bytes will be returned. The number of data groups for transmissions to the inverter is from 04 to 16 (04H – 10H) bytes. Note that the number of data returned by the inverters is variable.
- 4) Read data 1 (2 bytes) : The data of specified communication number is read.
- 5) Read data 2 (2 bytes) : The data of specified communication number + 1 is read.
- 6) Read data 3 (2 bytes) : The data of specified communication number + 2 is read.
- 7) Read data 4 (2 bytes) : The data of specified communication number + 3 is read.
- 8) Read data 5 (2 bytes) : The data of specified communication number + 4 is read.
- 9) Read data 6 (2 bytes) : The data of specified communication number + 5 is read.
- 10) Read data 7 (2 bytes) : The data of specified communication number + 6 is read.
- 11) Read data 8 (2 bytes) : The data of specified communication number + 7 is read.
- 12) CRC16 (2 bytes) : ---

- Inverter → Computer (Abnormal return) *The text size is 5 bytes fixed.

Inverter No.	Command	Error Code	CRC16	
			low	high
	83			

- 1) Inverter No (1 byte) : ---
- 2) Command (1 byte) : 83H fixed (Read command error) (Command + 80H)
- 3) Error code (1 byte) : See "5.3. Error codes".
- 4) CRC16 (2 bytes) : ---

■ Example: direct block read of 5 words

< Parameter >

F 8 0 2 (Inverter number) = 1

F 8 2 9 (Selection of communication protocol) = 1: Modbus RTU

F 1 3 0 = 4

F 1 3 1 = 6

F 1 3 2 = 10

F 1 3 3 : nonexistent



F 1 3 4 : nonexistent

(Computer → Inverter) 01 03 01 30 00 05 84 3A

(Inverter → Computer) 01 03 0A 00 04 00 06 00 0A 80 00 80 00 A0 77

Note: When a consecutive communication number doesn't exist, the data of 8000H is sent back.
Please confirm the range of the parameter.

5.1.4. Write command (06H, 10H)

 CAUTION	
 Mandatory action	♦ Do not write the same parameter to the EEPROM more than 10,000 times. The life time of EEPROM is approximately 10,000 times. (Some parameters are not limited, please refer to the “9. Parameter data”)

5.1.4.1. Write command (06)

- Computer → Inverter *The text size is 8 bytes fixed.

Inverter No.	Command	Communication No.		Write Data		CRC16	
		high	low	high	low	low	high
	06						

- 1) Inverter No. (1 byte) : ---
- 2) Command (1 byte) : Set the write command (06H fixed).
- 3) Communication No. (2 bytes) : Set in the order of high to low numbers.
- 4) Write data (2 bytes) : Set in the order of high to low write data.
- 5) CRC16 (2 bytes) : ---

- Inverter → Computer (Normal return) *The text size is 8 bytes fixed.

Note: The return packet and the sending packet are same.

Inverter No.	Command	Communication No.		Write Data		CRC16	
		high	low	high	low	low	high
	06						

- Inverter → Computer (Abnormal return) *The text size is 5 bytes fixed.

Inverter No.	Command	Error Code	CRC16	
			low	high
	86			

- 1) Inverter No (1 byte) : ---
- 2) Command (1 byte) : 86H fixed (Read command error) (Command + 80H)
- 3) Error code (1 byte) : See "5.3. Error codes".
- 4) CRC16 (2 bytes) : ---

■ Example: Writing in frequency command value (FA01) (60Hz)
 (Computer → Inverter) 01 06 FA 01 17 70 E6 C6
 (Inverter → Computer) 01 06 FA 01 17 70 E6 C6

■ Example: Communication number error
 (Computer → Inverter) 01 06 FF FF 00 00 89 EE
 (Inverter → Computer) 01 86 02 C3 A1

5.1.4.2. Write command (10H)

- Computer → Inverter *The text size is 11 bytes fixed.

Inverter No.	Command	Communication No.		Number of word		Number of byte	Write Data		CRC16	
		high	low	high	low		high	low	low	high
	10			00	01	02				

- 1) Inverter No. (1 byte) : ---
- 2) Command (1 byte) : Set the write command (10H fixed).
- 3) Communication No. (2 bytes) : Set in the order of high to low numbers.
- 4) Number of word (2 bytes) : 0001H (fixed).
- 5) Number of byte (1 bytes) : 02H (fixed).
- 6) Write data (2 bytes) : Set in the order of high to low write data.
- 7) CRC16 (2 bytes) : ---

- Inverter → Computer (Normal return) *The text size is 8 bytes fixed.

Inverter No.	Command	Communication No.		Number of word		CRC16	
		high	low	high	low	low	high
	10			00	01		

- 1) Inverter No. (1 byte) : ---
- 2) Command (1 byte) : Set the write command (10H fixed).
- 3) Communication No. (2 bytes) : Set in the order of high to low numbers.
- 4) Number of word (2 bytes) : 0001H (fixed).
- 5) CRC16 (2 bytes) : ---

- Inverter → Computer (Abnormal return) *The text size is 5 bytes fixed.

Inverter No.	Command	Error Code	CRC16	
			low	high
	90			

- 1) Inverter No (1 byte) : ---
- 2) Command (1 byte) : 90H fixed (Write command error) (Command + 80H)
- 3) Error code (1 byte) : See "5.3. Error codes".
- 4) CRC16 (2 bytes) : ---

- Example(One word write) : Writing in frequency command value (FA01) (60Hz)
 (Computer → Inverter) 01 10 FA 01 00 01 02 17 70 F3 9A
 (Inverter → Computer) 01 10 FA 01 00 01 60 D1

5.1.5. Block Write command (10H)

Select data, which is desired to be written in block communications, in Block Communication Write Data 1 and 2 Parameters (*F870, F871*). This parameter becomes effective when the system is reset, such as when power is turned off. When the setting is completed, turn off and then on the power.

No.	Block write data	Reference
0	No selection	-
1	Communication command 1 (FA00)	"8.1. Command by communication"
2	Communication command 2 (FA20)	
3	Frequency command value (FA01)	
4	Output data on the terminal board (FA50)	
5	FM analog output (FA51)	
6	Motor speed command (FA13)	

* When "No selection" is specified in the parameters, no data will be written even though write data is specified.

- Computer → Inverter *The text size is 13 bytes fixed.

Inverter No.	Command	Communication No.		Number of word		Number of byte	Write Data 1		Write Data 2		CRC16	
		high	low	high	low		high	low	high	low	low	high
	10	18	70	00	02	04						

- 1) Inverter No. (1 byte) : ---
- 2) Command (1 byte) : Set the block write command (10H fixed).
- 3) Communication No. (2 bytes) : Set in the order of high to low numbers (1870H fixed).
- 4) Number of word (2 bytes) : 0002H (fixed).
- 5) Number of byte (1 bytes) : 04H (fixed).
- 6) Write data 1(2 bytes) : Set in the order of high to low write data 1.
The data is written to the specified parameter selected by *F870*.
- 6) Write data 2(2 bytes) : Set in the order of high to low write data 2.
The data is written to the specified parameter selected by *F871*.
- 8) CRC16 (2 bytes) : ---

- Inverter → Computer (Normal return) *The text size is 8 bytes fixed.

Inverter No.	Command	Communication No.		Number of word		CRC16	
		high	low	high	low	low	high
	10	18	70	00	02		

- 1) Inverter No. (1 byte) : ---
- 2) Command (1 byte) : 10H (fixed).
- 3) Communication No. (2 bytes) : 1870H (fixed).
- 4) Number of word (2 bytes) : 0002H (fixed).
- 5) CRC16 (2 bytes) : ---

- Inverter → Computer (Abnormal return) *The text size is 5 bytes fixed.

Inverter No.	Command	Error Code	CRC16	
			low	high
	90			

- 1) Inverter No (1 byte) : ---
- 2) Command (1 byte) : 90H fixed (Read command error) (Command + 80H)
- 3) Error code (1 byte) : See "5.3. Error codes".
- 4) CRC16 (2 bytes) : ---

■ Example: Set the operation frequency(FA01=60.00Hz) and forward run command value by RS485

< Parameter >

F B 0 2 (Inverter number) = 1

F B 2 9 (RS485 protocol selection) = 1: Modbus RTU

F B 7 0 (Block write data 1) = 1: Communication command 1

F B 7 1 (Block write data 2) = 3: Frequency command value

note) If the bits "bit14 (Frequency priority selection) " and "bit15 (Command priority selection) " of RS485 communication command 1 (FA00) are not set, please set *F 7 0 d* to "4:RS485 communication", and *7 0 d* to "2:RS485 communication ".

(Computer → Inverter) 01 10 18 70 00 02 04 C4 00 17 70 6D AF

(Inverter → Computer) 01 10 18 70 00 02 46 B3

■ Example: (Inverter is busy or *F B 7 0, F B 7 1* is 0)

(Computer → Inverter) 01 10 18 70 00 02 04 C4 00 17 70 6D AF

(Inverter → Computer) 01 90 04 4D C3

■ Example: Communication number error

(Computer → Inverter) 01 10 18 71 00 02 04 C4 00 17 70 AC 63

(Inverter → Computer) 01 90 03 0C 01

■ Example: Data range error

(Computer → Inverter) 01 10 18 70 00 03 04 C4 00 17 70 6C 7E

(Inverter → Computer) 01 90 03 0C 01

5.1.6. Block Write and Read command (17H)

Select data, which is desired to be written in block communications, in Block Communication Write Data 1 and 2 Parameters (FB70, FB71). Then, Select read data, which is desired to be read in block communication, in block read data 1 and 5 Parameters (FB75 to FB79).

This parameter becomes effective when the system is reset, such as when power is turned off. When the setting is completed, turn off and then on the power.

No.	Block write data	Reference
0	No selection	-
1	Communication command 1 (FA00)	"8.1. Command by communication"
2	Communication command 2 (FA20)	
3	Frequency command value (FA01)	
4	Output data on the terminal board (FA50)	
5	FM analog output (FA51)	
6	Motor speed command (FA13)	

* When "No selection" is specified in the parameters, no data will be written even though write data is specified.

No.	Block read data	Reference
0	No selection	-
1	Status information 1 (FD01)	"8.2. Monitoring from communication"
2	Output frequency (FD00)	
3	Output current (FD03)	
4	Output voltage (FD05)	"9. Parameter data"
5	Alarm information 1 (FC91)	"8.2. Monitoring from communication"
6	PID feedback value (FD22)	"9. Parameter data"
7	Input terminal monitor (FD06)	"8.2. Monitoring from communication"
8	Output terminal monitor (FD07)	
9	Terminal VIA monitor (FE35)	
10	Terminal VIB monitor (FE36)	
11	Terminal VIC monitor (FE37)	
12	Input voltage (FD04)	
13	Motor speed (FE90)	
14	Torque (FD18)	

* "0000" will be returned as dummy data, if "0 (No selection)" is selected for the parameter and "read" is specified.

- Computer → Inverter *The text size is 13 bytes fixed.

INV-NO	CMD	Read communication No.		Read number of word		Write communication No.		Write number of word	
		high	low	high	high	low	low	low	high
	17	18	75	00		18	70	00	02

Number of byte	Write data 1		Write data 2		CRC16	
	high	low	high	low	low	high
04						

- 1) Inverter No. (1 byte) : ---
- 2) Command (1 byte) : Set the block write and read command (17H fixed).
- 3) Read communication No. (2 bytes) : Set in the order of high to low numbers (1875H fixed).
- 4) Read number of word : Set the number of word from 2 to 5.
- 5) Write communication No. : Set in the order of high to low numbers (1870H fixed).

- 6) Write number of word : 0004H(fixed).
- 7) Write number of byte : 0002H(fixed).
- 8) Write data 1(2 bytes) : Set in the order of high to low write data 1.
The data is written to the specified parameter selected by *F B 7 0*.
- 9) Write data 2(2 bytes) : Set in the order of high to low write data 2.
The data is written to the specified parameter selected by *F B 7 1*.
- 10) CRC16 (2 bytes) : ---

• Inverter → Computer (Normal return) *The text size is variable.

Inverter No.	Command	Number of data	Read data 1		...	Read data 8		CRC16	
			high	low		high	low	low	high
	17	04-16							

- 1) Inverter No. (1 byte) : ---
- 2) Command (1 byte) : 10H (fixed).
- 3) Communication No. (2 bytes) : 1870H(fixed).
- 4) Number of word (2 bytes) : 0002H(fixed).
- 5) CRC16 (2 bytes) : ---

• Inverter → Computer (Abnormal return) *The text size is 5 bytes fixed.

Inverter No.	Command	Error Code	CRC16	
			low	high
	97			

- 1) Inverter No (1 byte) : ---
- 2) Command (1 byte) : 90H fixed (Read command error) (Command + 80H)
- 3) Error code (1 byte) : See "5.3. Error codes".
- 4) CRC16 (2 bytes) : ---

5.1.7. Identification command (2BH)

- Computer → Inverter *The text size is 7 bytes fixed.

Inverter No.	Command	Type of MEI	Read device ID	Object ID	CRC16	
					low	high
	2B (fixed)	0E (fixed)	00-03 (variable)	00 (fixed)		

- 1) Inverter No. (1 byte) : ---
- 2) Command (1 byte) : Set the Identification command (2BH fixed).
- 3) Type of MEI (1 byte) : 0EH fixed.
- 4) Read Device ID (1 byte) : 00-03H
- 5) Object ID (1 byte) : 00H fixed.
- 6) CRC16 (2 bytes) : ---

- Inverter → Computer (Normal return) *The text size is variable.

Inverter No.	Command	Type of MEI	Read Device Id	Degree of conformity	Number of additional frames	Next object Id	Number of objects
	2B (fixed)	0E (fixed)	00-03 (variable)	01 (fixed)	00 (fixed)	00 (fixed)	03 (fixed)

Id of object no.1	Length of object no.1	Value of object no.1
00 (fixed)	07 (fixed)	"TOSHIBA" (fixed)

Id of object no.2	Length of object no.2	Value of object no.2
01 (fixed)	0C (variable)	"VFS15-2037PM" (variable) Note: See Appendix 3.

Id of object no.3	Length of object no.3	Value of object no.3(4 bytes)
02 (fixed)	04 (fixed)	"0100" (variable)

CRC16	
low	high

The total response size is variable.

The three objects contained in the response correspond to the following objects:

Object no.1: Manufacturer name ("TOSHIBA").

Object no.2: Device reference (ASCII string ; ex. : " VFS15-2037PM"). Note: See Appendix 3.

Object no.3: Device version (4-byte ASCII string; for example: "0100" for version 100).

- Inverter → Computer (Abnormal return) *The text size is 5 bytes fixed.

Inverter No.	Command	Error Code	CRC16	
			low	high
	AB			

- 1) Inverter No (1 byte) : ---
- 2) Command (1 byte) : ABH fixed (Read command error) (Command + 80H)
- 3) Error code (1 byte) : See "5.3. Error codes".
- 4) CRC16 (2 bytes) : ---

■ Example: Reading Identification

Inverter No = 01H
 Manufacturer name = "TOSHIBA"(7 bytes)
 Device name = "VFS15-2037PM" (12 bytes)
 Device version = "0100" (4 bytes)

```
(Computer → Inverter) 01 2B 0E 01 00 70 77
(Inverter → Computer) 01 2B 0E 01 01 00 00 03
                      00 07 54 4F 53 48 49 42 41
                      01 0C 56 46 53 31 35 2D 32 30 33 37 50 4D
                      02 04 30 31 30 30
                      13 45
```

5.2. CRC Generation

“CRC” is a system to check errors in communication frames during data transmission. CRC is composed of two bytes and has hexadecimal-bit binary values. CRC values are generated by the transmission side that adds CRC to messages. The receiving side regenerates CRC of received messages and compares generation results of CRC regeneration with CRC values actually received. If values do not match, data will be aborted.

- Flow

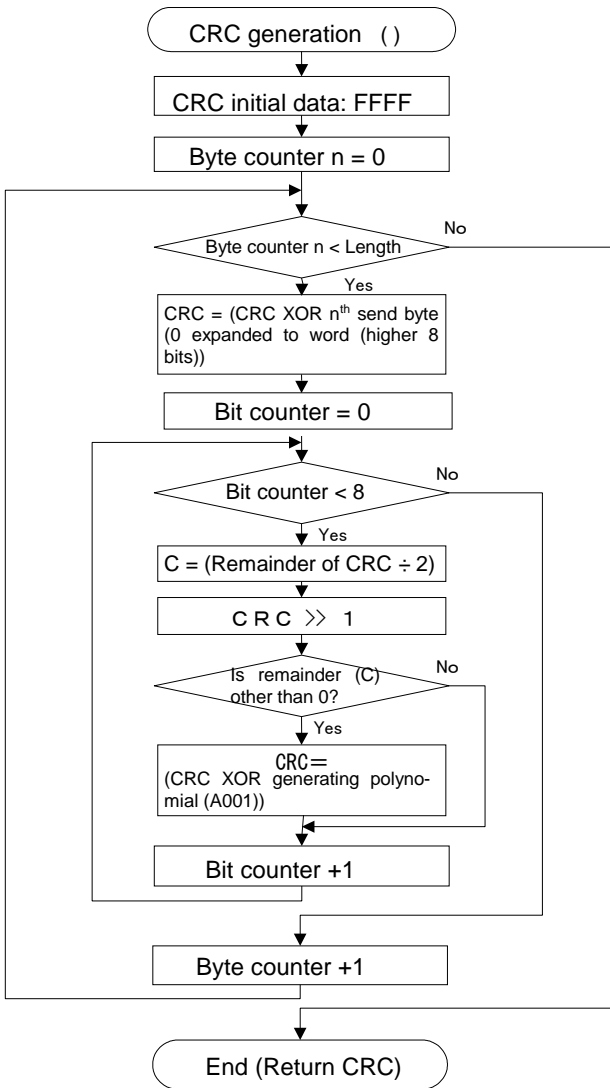

A procedure for generating a CRC is:

- 1, Load a 16-bit register with FFFF hex (all 1's). Call this the CRC register.
- Exclusive OR the first 8-bit byte of the message with the low-order byte of the 16-bit CRC register, putting the result in the CRC register.
- Shift the CRC register one bit to the right (toward the LSB), zero-filling the MSB. Extract and examine the LSB.
- (If the LSB was 0): Repeat Step 3 (another shift).
(If the LSB was 1): Exclusive OR the CRC register with the polynomial value A001 hex (1010 0000 0000 0001).
- Repeat Steps 3 and 4 until 8 shifts have been performed. When this is done, a complete 8-bit byte will have been processed.
- Repeat Steps 2 through 5 for the next 8-bit byte of the message. Continue doing this until all bytes have been processed.
- The final contents of the CRC register is the CRC value.
- When the CRC is placed into the message, its upper and lower bytes must be swapped as described below.

5.3. Error codes

In case of the following errors, the return commands from the inverters are added 80h to the commands received by the inverters. The following error codes are used.

Error Code	Description
01	<ul style="list-style-type: none"> - Command error - Function code 43 supported but MEI Type not equal to 14
02	<ul style="list-style-type: none"> - Communication number error - It tried to write to parameter with only reading.
03	<ul style="list-style-type: none"> - Data range error - Fixed-data error - Function code 43 and MEI Type 14 supported but invalid Read Device ID Code (Read Device ID code > 3)
04	<ul style="list-style-type: none"> - Unable to execute - Writing in write-disable-during-operation parameter - Writing in parameter that is executing TYP - F700 (Parameter protection selection) is 2:Writing prohibited (RS485), 4:Writing and Reading prohibited (RS485) - If F738 (Password setting) was set to data, F738 can not set to data.

6. Inter-drive communication

Inter-drive communication (communication between inverters) are used, for example, when performing speed proportional control of two or more inverters without using a PLC or computer. The command is instructed by the operation from the master inverter's panel or analog input, etc.

With the Inter-drive communication function, the master inverter continues to transmit the data selected by the parameters to all the slave inverters on the same network. The master inverter uses the S command for outputting instructions to the slave inverters, and the slave inverters do not return the data. (See "4.2. Commands".) Network construction for a simple synchronized operation and speed-proportional operation can be created by this function.

* If the master inverter trips, the slave inverters display the blinking error code "t" and come to a full stop (0Hz). See the parameter (*F805*) on the next page.

After the master inverter was reset, the blinking error code "t" is lost.

* With the communication time-out parameters *F803* and *F804*, you can specify what the slave inverters should do (continue to operate, issue an alarm or trip) if a cable is broken or the master inverter is turned off during operation.

* To use the inter-drive communication function, select "Toshiba inverter protocol" (*F829=0*) in the communication protocol selection parameters. "Toshiba inverter protocol" (*F829=0*) is set for communication protocol selection in Shipment setting. (See "3. Communication protocol".)

<Conceptual illustration (RS485 communication)>

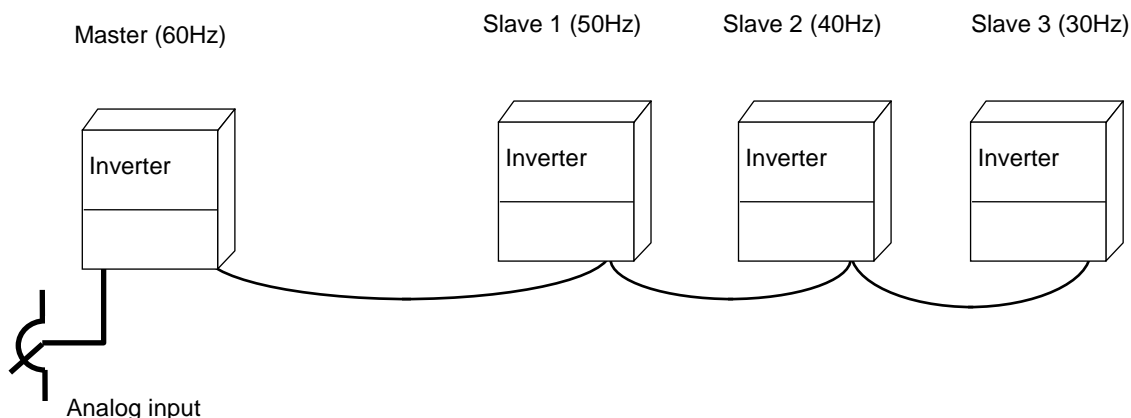

<Notes>

Speed command can be transmitted but the run / stop signal is not issued. Slave station should have an individual stop signal or the function to stop the action by the frequency reference. (Setting is necessary for *F241*: Operation start frequency, *F242*: Operation start frequency hysteresis.)

For continuing the operation by the last received command value in the case of a communication breakdown, communications time-out time (*F803*) to trip the slave inverters. The master inverter does not trip even though the communication breakdown happens. To trip the master inverter, provide an interlock mechanism by installing an FL fault relay point or the like from the slave side.

- Setting of parameter

- Protocol selection (F829) Shipment setting: 0 (TOSHIBA)

Protocol setting with all inverters (both master and slave inverters) engaged in inter-drive communication

0: Set the TOSHIBA.

*Inter-drive communication are disabled when Modbus RTU protocol is selected.

*This parameter is validated after resetting the inverter or rebooting the power supply.

- Setting of master and slave inverters for communication between inverters (setting of master and slave) (F806) ... Shipment setting = 0

Assign one master inverter in the network. Other inverters should be the slave inverters.

*Specify only one inverter as the master. In case two or more inverters are designated for the master inverter in the same network, data will collide.

- Setting to the master inverter

Set data desired for sending from the master side to the slave side.

3: Master (transmission of frequency commands)

4: Master (transmission of output frequency signals)

- Setting to the slave inverters

Set the desired action on the slave side that will be needed when the master trips.

0: Slave (0 Hz command issued in case the master inverter fails)

(The output frequency is limited to the lower limit frequency.)

1: Slave (Operation continued in case the master inverter fails)

Note: If the master inverter trips when an output frequency is specified for it, the operation frequency of the slave inverters become 0Hz because tripping of the master inverter causes its output frequency to drop to 0Hz.

2: Slave (Emergency stop tripping in case the master inverter fails)

The way they make an emergency stop depends on the setting of F603 (emergency stop).

*This parameter is validated after resetting the inverter or rebooting the power supply.

- Communication waiting time (F805) ... Shipment setting = 0.00

- Setting to the master inverter

Specify a waiting time if you want the master to issue commands to slaves with a given delay.

- Frequency setting mode selection 1 (F70d) ... Shipment setting = 0: Setting dial 1

Designate a target of speed command input for the inverter to the parameter F70d.

- Setting to the master inverter

Select except RS485 communication (F70d ≠ 4).

- Setting to the slave inverters

Select RS485 communication (F70d=4)

- Relating communication parameters

Following parameters should be set or changed if necessary.

- Baud rate (F800)... Shipment setting = 4: 19200bps

Baud rate of all inverters in the network (master and slave) should be same network.

- Parity (F801) ... Shipment setting = 1: Even parity

Parity of all inverters in the network (master and slave) should be same network.

- Communication time-out time (F803) ... Shipment setting = 0.0

Operation is continued by the last received command value in the case of a communication breakdown. To stop the operation of inverter, provide a communication time-out time (ex. F803= 1.0 second) to the slave inverters. The master inverter does not trip even though the communication breakdown happens. To trip the master inverter, provide an interlock mechanism by installing a FL fault relay point or the like from the slave side.

- Communication waiting time (F805)

When the slave inverter is bad response, the interval time is short. In this case, the communication waiting time (F805) is set to 0.0 1sec.

- Frequency point selection (F810, F811-F814)

The command from master inverter can be performed by the parameter of the point setting. See "6.1 Speed proportional control" for details.

- Setting example of parameters

Parameters relating to the master side (example)

F806:3 Master (transmission of frequency commands (%)(100% at FH))
 F829:0 Selection of communication protocol (Toshiba inverter protocol)
 F800:4 Baud rate (ex. 19200bps)
 F801:1 Parity (Even parity)
 C00d:1 Example: Panel keypad
 F00d:2 Example: Terminal VIB
 F805:0.0 1 Communication waiting time

Parameters relating to the slave side (example)

F806:0 Slave (0 Hz command issued in case the master inverter fails)
 F829:0 Selection of communication protocol (Toshiba inverter protocol)
 F803:1.0 Communication time-out time (ex. 1 second)
 F800:4 Baud rate (same to the master side)
 F801:1 Parity (same to the master side)
 C00d:0 Terminal block (ex. Driven by F, ST) (F24 1:Run and stop of operation is controlled with the frequency reference value by setting the "run frequency".)
 F00d:4 RS485 communication
 F810:1 Enabled
 F811:? Adjusted to the system Point 1 setting (%)
 F812:? Ditto Point 1 frequency (Hz)
 F813:? Ditto Point 2 setting (%)
 F814:? Ditto Point 2 frequency (Hz)

6.1. Speed proportional control

Proportional control of frequency can be performed in two ways: control by selecting frequency points and control by adjusting the ratio to the maximum frequency. This section explains proportional control of inverters by means of a master inverter (inter-drive communication), although the VF-S15 series inverters are ready for proportional control by means of the "S" command even when they are operated under the control of a computer (computer-linked communication) (in the latter cases, read the master inverter as the computer).

Proportional control can also be performed in units of Hz using ordinary write commands (W and P commands) (frequency point selection only). For proportional control in units of %, however, the S command should be used.

* For proportional control by selecting frequency points, the gradient can be set variously according to the way each inverter is used. For proportional control by controlling the ratio to the maximum frequency, settings can be made easily without consideration of the rate at which the frequency is increased or decreased to the target frequency.

• Data sent by the master inverter to slave inverters in inter-drive communication mode (frequency command value)

$$fc(\%) = \frac{\text{Master side } fc \times 10000}{\text{Master side } FH} \quad (1=0.01\%)$$

* Fractions under 1 (0.01%) are omitted. Therefore, an error of 0.01% is introduced at the maximum.

• Conversion of the frequency command received by a slave inverter (when the "frequency point selection" option is not selected)

The value obtained by the following conversion calculation is written in RAM as a frequency command value.

$$fc(\text{Hz}) = \frac{\text{Slave receive data}(\%) \times \text{Slave side } FH}{10000} \quad (1=0.01\text{Hz})$$

* Fractions under 1 (0.01Hz) are omitted. Therefore, an error of 0.01Hz is introduced at the maximum.

[Diagram of speed proportional control]

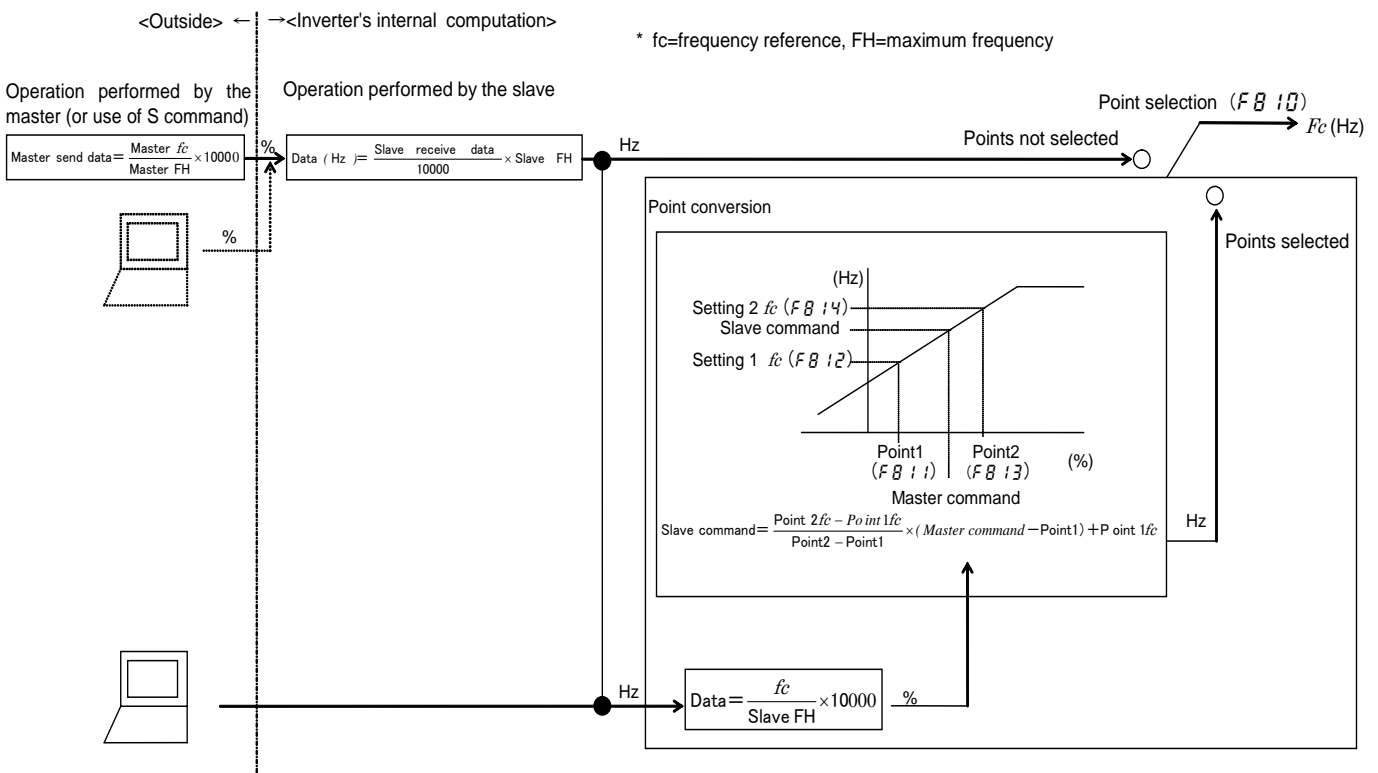

• If the “Frequency point selection” function is disabled ($FB10=0$)

The operation frequency (frequency command value) of the inverters are calculated using the following equations, with the received data in the following equation used as the data received from the master inverter when inverters are operated under the control of a master inverter (inter-drive communication), or with the received data in the following equation used as the data received from the computer when inverters are operated under the control of a computer (computer-linked operation).

$$fc(Hz) = \frac{\text{Slave receive data}(\%) \times \text{Slave side FH}}{10000} \quad (\text{Hz})$$

Example:

Unit:1=0.01Hz

	Maximum frequency	Operation frequency command value
Master (Fc)	100.00Hz (10000)	50.00Hz (5000)
Slave 1	90.00Hz (9000)	45.00Hz (4500)
Slave 2	80.00Hz (8000)	40.00Hz (4000)

$$\text{Master send data: } fc(\%) = \frac{\text{Master side } fc \times 10000}{\text{Master side FH}} = \frac{5000 \times 10000}{10000} = 5000 = 50\%$$

$$\text{Slave 1: } fc(Hz) = \frac{5000 \times 9000}{10000} = 4500 = 45Hz$$

$$\text{Slave 2: } fc(Hz) = \frac{5000 \times 8000}{10000} = 4000 = 40Hz$$

• If the “Frequency point selection” function is enabled ($FB10 \neq 0$)

When inverters are operated under the control of a mater inverter, the operation frequency (frequency command value) of the slave inverters are calculated using the following equations. Just as the master inverter is calculated to the data, personal computer has to send the same data.

$$fc(Hz) = \frac{\text{Point 2 frequency} - \text{Point 1 frequency}}{\text{Point 2} - \text{Point 1}} \times (\text{Master command}(\%) - \text{Point 1}) + \text{Point 1 frequency}$$

Example:

Units: Frequency unit 1 = 0.01Hz, Point setting unit 1 = 0.01%

	Maximum frequency (FH)	Point 1 setting (FB11)	Point 1 frequency (FB12)	Point 2 setting (FB13)	Point 2 frequency (FB14)	Frequency (Fc)
Master (Fc)	100.00Hz (10000)	-	-	-	-	50.00Hz (5000)
Slave 1	100.00Hz (10000)	0.00% (0)	0.00Hz (0)	100.00% (10000)	90.00Hz (9000)	45.00Hz (4500)
Slave 2	100.00Hz(10000)	0.00% (0)	0.0Hz (0)	100.00%(10000)	80.00Hz (8000)	40.00Hz (4000)

Data sent by the master inverter

$$\text{Master send data: } fc(\%) = \frac{\text{Master side } fc \times 10000}{\text{Master side FH}} = \frac{5000 \times 10000}{10000} = 5000 = 50\%$$

Results of conversions to point frequency (for the equation used, see above.)

$$\text{Slave 1: } fc(Hz) = \frac{9000 - 0}{10000 - 0} \times (5000 - 0) + 0 = 4500 = 45Hz$$

$$\text{Slave 2: } fc(Hz) = \frac{8000 - 0}{10000 - 0} \times (5000 - 0) + 0 = 4000 = 40Hz$$

6.2. Transmission format for inter-drive communication

Data type is handled in hexadecimal notation and the transmission characters are treated with the binary (HEX) code.

The transmission format is basically the same to the case of binary mode. S command is used and the slave inverters do not return the data.

- Master inverter → Slave inverter (Binary mode)

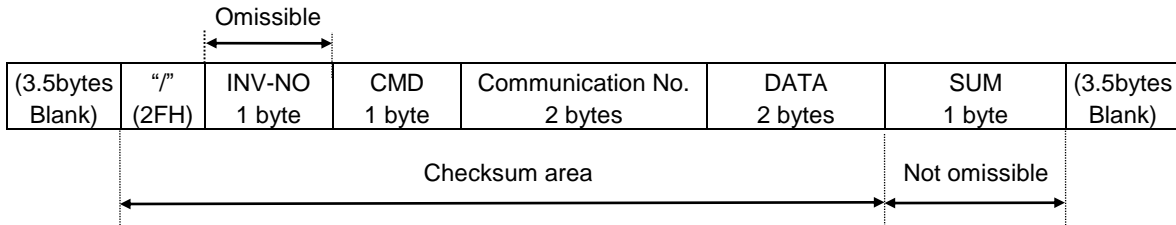

- 1) INV-NO (1 byte) : Inverter number
This is always excluded at the master inverter side at time of inter-drive communication, and can be added when the user utilize this data for the purpose of proportional operation. (When this code is added, only the inverter concerned will accept the data.)
- 2) CMD (1 byte) : Command
53H ("S") or 73H ("s") command ... command for inter-drive communication
When the master inverter is not tripping, this will be 53H ("S").
When the master inverter is tripping, this will be 73H ("s").
- 3) Communication number (2 bytes) :
Specify "FA01" for RS485 communication.
- 4) DATA (2 bytes) : Instruction data to slave (0 to 10000:100=1%)

As for the S command, see "4.2. Commands", and see "6. Inter-drive communication function" for the communication of inverters.

7. Communication parameters

The settings of communication-related parameters can be changed from the operation panel and the external controller (computer). Note that there are two types of parameters: parameters whose settings take effect immediately after the setting and parameters whose settings do not take effect until the inverter is turned back on or reset.

Communication Number.	Title	Function	Adjustment range	Unit	Default setting	Valid	Reference
0719	<i>F719</i>	Selection of operation command clear	0: Clear at coast stop and retained at <i>NOFF</i> 1: Retained at coast stop and <i>NOFF</i> 2: Clear at coast stop and <i>NOFF</i> 3: 2+ clear when <i>ENOD</i> is changed	-	1	Real time	Section 7.7
0800	<i>F800</i>	Baud rate	3: 9600bps 4: 19200bps 5: 38400bps	-	4	After reset.	Section 7.1
0801	<i>F801</i>	Parity	0: Non parity 1: Even parity 2: Odd parity	-	1	After reset.	Section 7.1
0802	<i>F802</i>	Inverter number	0-247	1	0	Real time	Section 7.2
0803	<i>F803</i>	Communication time-out time	0.0: Disabled 0.1-100.0s	0.1s	0.0	Real time	Section 7.3
0804	<i>F804</i>	Communication time-out action	0: Alarm only 1: Trip (Coast stop) 2: Trip (Deceleration stop)	-	0	Real time	
0805	<i>F805</i>	Communication waiting time	0.00-2.00	0.01s	0.00	Real time	Section 7.4
0806	<i>F806</i>	Setting of master and slave for communication between inverters	0: Slave (0 Hz command issued in case the master inverter fails) 1: Slave (Operation continued in case the master inverter fails) 2: Slave (Emergency stop tripping in case the master inverter fails) 3: Master (transmission of frequency commands) 4: Master (transmission of output frequency signals)	-	0	After reset.	Chapter 6
0808	<i>F808</i>	Communication time-out detection condition	0: Always 1: During communication mode *1 2: 1+running	-	1	Real time	Section 7.3
0810	<i>F810</i>	Frequency point selection	0: Disabled 1: Enabled	-	0	Real time	Section 6.13
0811	<i>F811</i>	Communication command point selection	0-100%	1%	0		
0812	<i>F812</i>	Communication command point 1 setting	0- <i>F</i> Hz	0.01Hz	0.0		
0813	<i>F813</i>	Communication command point 1 frequency	0-100%	1%	100		
0814	<i>F814</i>	Communication command point 2 setting	0- <i>F</i> Hz	0.01Hz	60.0		
0829	<i>F829</i>	Selection of communication protocol	0: Toshiba inverter protocol 1: Modbus RTU protocol	-	0	After reset.	Chapter 3
0856	<i>F856</i>	Number of motor poles for communication	1: 2poles, 2: 4poles, - 8: 16poles	-	2	Real time	Section 8.1

Communication Number.	Title	Function	Adjustment range	Unit	Default setting	Valid	Reference
0870	<i>F870</i>	Block write data 1	0: No selection				
0871	<i>F871</i>	Block write data 2	1: Communication command 1 (FA00) 2: Communication command 2 (FA20) 3: Frequency command value (FA01) 4: Output data on the terminal board (FA50) 5: FM analog output (FA51) 6: Motor speed command (FA13)	-	0	After reset.	
0875	<i>F875</i>	Block read data 1	0: No selection				Section 4.1.3 5.1.2 5.1.5 5.1.6
0876	<i>F876</i>	Block read data 2	1: Status information 1 (FD01)				
0877	<i>F877</i>	Block read data 3	2: Output frequency (FD00)				
0878	<i>F878</i>	Block read data 4	3: Output current (FD03)				
0879	<i>F879</i>	Block read data 5	4: Output voltage (FD05) 5: Alarm information 1 (FC91) 6: PID feedback value (FD22) 7: Input terminal monitor (FD06) 8: Output terminal monitor (FD07) 9: Terminal VIA monitor (FE35) 10: Terminal VIB monitor (FE36) 11: Terminal VIC monitor (FE37) 12: Input voltage (FD04) 13: Motor speed (FE90) 14: Torque (FD18)	-	0	After reset.	
0880	<i>F880</i>	Free notes	0-65535	1	0	Real time	Section 7.5
0899	<i>F899</i>	Communication function reset	0: - 1: Reset (after execution: 0)	-	0	Real time	Section 7.6

*1: The inverter is in communication mode when *F800* is 4:RS485 communication or *C800* is 2:RS485 communication, Communication command 1 (FA00) is set to bit14 (Frequency priority selection) or bit15 (Command priority selection).

7.1. Baud rate (F800), Parity (F801)

- Communication baud rate and parity bit should be uniform inside the same network.
- This parameter is validated by resetting the power supply.

7.2. Inverter number (F802)

This parameter sets individual numbers with the inverters.

Inverter numbers should not be duplicated inside the same network.

Receiving data will be canceled if inverter numbers specified in individual communication and set by a parameter do not match.

This parameter is validated from the communication after change

Data range: 0 to 247 (Initial value: 0)

~~Parameters can be selected between 0 and 247. Note that the communication protocols limit inverter numbers as follows:~~

- Toshiba inverter protocol ASCII mode: 0 to 99
- Toshiba inverter protocol Binary mode: 0 to 63
- Modbus RTU protocol: 0 to 247 (0: Broadcast communication)

7.3. Communication time-out detection (F803) (F804) (F808)

The timer function is mainly used to detect a break in a cable during communication, and if no data is sent to an inverter within the preset time, this function makes the inverter trip (Err5) or issue an alarm (E). With the communication time-out action parameter (F804), you can specify what the inverter should do (trip, issue an alarm or do nothing) if a time-out occurs.

• How to set the timer

By default, the communication time-out time parameter (F803) is set to 0.0 (Disabled).

* Timer adjustment range

0.1 sec. (01H) to 100.0 sec. (3E8H) / Timer off is 0.0 sec.

• How to start the timer

If the timer is set from the operation panel, it will start automatically the instant when communication is established for the first time after the setting.

If the timer is set from the computer, it will start automatically the instant when communication is established after the setting.

If the timer setting is stored in the EEPROM, the timer will start when communication is established for the first time after the power has been turned on.

Note that, if the inverter number does not match or if a format error occurs, preventing the inverter from returning data, the timer function will assume that no communication has taken place and will not start.

• How to specify what an inverter should do if a time-out occurs

By default, the communication time-out action parameter (F804) is set to 0 (Alarm only). The data of 1 is trip (Err5) and coast stop. The data of 2 is trip (Err5) after deceleration stop.

• Time-out detection condition

By default, the communication Time-out detection (F808) is set to 1 (When communication-mode is selected).

When it is set to 0, it always detects time-out error.

When it is set to 2, it detects time-out error during communication-mode and running.

• How to disable the timer

Set 0.0 (Disabled) to the parameter (F803).

Ex.: To disable the timer function from the computer (To store the timer setting in the EEPROM)

Computer → Inverter

Inverter → Computer

(W08030)CR

(W08030000)CR

... Sets the timer parameter to 0 to disable it.

• Timer

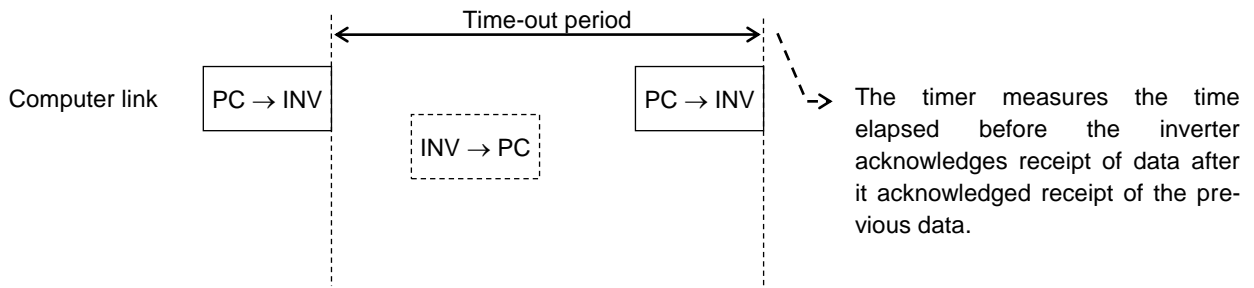

7.4. Communication waiting time (*F805*)

Use this function for the following case:

When the data response from the inverter is too quick after the PC had sent the data to the inverter, PC process cannot get ready to receive the data, or when the USB/RS485, RS485/RS232C converter is used, changeover of sending and receiving data takes much time in the converter process.

Functional specification:

A time for sending data is prolonged longer than the preset time (*F805*), until the inverter returns the data to the PC, after it finishes receiving the data (in case of an inter-drive communication, until the inverter returns the next data to the PC, after it has sent the data.) In case the inverter's processing capacity requires longer setting time, the value more than this time will be the set value. (The parameter makes the inverter wait for more than the set time.)

Setting range: 0.01 to 2.00 seconds (10ms to 2000ms)

If the set value is 0, this function becomes invalid and the interval time for sending data is set to the maximum capacity of the inverter. To obtain a quick response for sending data, set value 0.

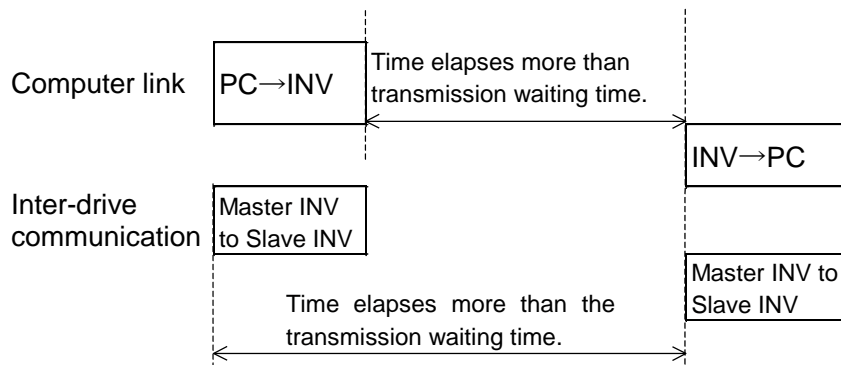

7.5. Free notes (*F880*)

This parameter allows you to write any data, e.g., System number, Management information, which does not affect the operation of the inverter.

7.6. Communication function reset (*F899*)

This parameter can use to update the data by reset after communication parameter was changed. Don't use this parameter when the inverter is trip status.

7.7. Selection of operation command clear (*F719*)

In case of *F719* = 1, operation command is cleared when coast stop or under voltage (*n0FF*) is occurred. In case of *F719* = 2, in addition to the foregoing function, operation command is cleared when the command mode is changed by *cn0d* or FA00 bit:15 (Command priority selection).

8. Commands and monitoring from the computer

Across the network, instructions (commands and frequency) can be sent to each inverter and the operating status of each inverter can be monitored.

8.1. Communication commands (commands from the computer)

• Communication command 1 (FA00)

Commands can be executed on inverter frequencies and operation stop through communication. The VF-S15 series can enable command and frequency settings through communication irrespective of settings of the command mode selection (\underline{CND}) and frequency setting mode selection 1 (\underline{FNQ}). However, if “48 (49): Forced switching from communication to local is set by input terminal function selection ($F104, F108, F110$ to $F115$), a change to a command other than communication and to a frequency command is feasible through a contact on the terminal block.

Once the communication command (FA00) is set to enable communication command priority and frequency priority, both priorities will be enabled unless OFF is set, power is turned off or is reset, or factory default setting (\underline{tYP}) is selected. Emergency stop and PID control are always enabled even though communication command priority is not set.

Table 1 Data construction of communication commands (communication number: FA00)

bit	Specifications	0	1	Remarks
0	Preset speed operation frequencies 1	Preset speed operation is disabled or preset speed operation frequencies (1-15) are set by specifying bits for preset speed operation frequencies 1-4. (0000: Preset speed operation OFF, 001-1111: Setting of preset speed operation frequencies (1-15))		
1	Preset speed operation frequencies 2			
2	Preset speed operation frequencies 3			
3	Preset speed operation frequencies 4			
4	Motor selection (1 or 2) (THR 2 selection)	Motor 1 (THR 1)	Motor2 (THR2)	THR1: $\underline{P\acute{e}}$ =setting value, $\underline{uL}, \underline{uLv}, \underline{ub}, \underline{tHr}$ THR2: $\underline{P\acute{e}}=0, F170, F171, F172, F173$
5	PID control OFF	PID control permitted	PID control prohibited	
6	Acceleration/deceleration pattern selection (1 or 2) (AD2 selection)	Acceleration/deceleration pattern 1 (AD1)	Acceleration/deceleration pattern 2 (AD2)	AD1: $\underline{ACC}, \underline{dEC}$ AD2: $\underline{F500}, \underline{F501}$
7	DC braking	OFF	Forced DC braking	
8	Jog run	OFF	Jog run	
9	Forward/reverse run selection	Forward run	Reverse run	
10	Run/stop	Stop	Run	
11	Coast stop command	Standby	Coast stop	
12	Emergency stop	OFF	Emergency stop	Always enabled, “ \underline{E} ” trip
13	Fault reset	OFF	Reset	No data is returned from the inverter.
14	Frequency priority selection	OFF	Enabled	Enabled regardless of the setting of \underline{FNQ}
15	Command priority selection	OFF	Enabled	Enabled regardless of the setting of \underline{CND}

Ex.: Forward run command used in two-wire RS485 communication (PFA008400) CR
1 is specified for bit 15 (communication command: enabled) and bit 10 (operation command).

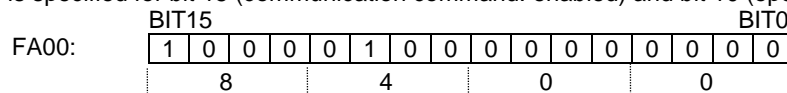

Ex.: Reverse run command used in two-wire RS485 communication (PFA008600) CR, (PFA00C600) CR
8600H : To disable frequency instructions from the computer
C600H : To enable also frequency instructions from the computer

■ **Communication command 2 (FA20)**

This command is enabled only when the communication command is enabled. Set Bit 15 of Communication Command 1 (communication Number: FA00) to "1" (enable). When enabling the communication command by Communication Command 1, commands by communication can be given the priority irrespective of the setting of the command mode selection parameter (*CMD*). However, if "48 (49): Forced switching from communication to local is set by input terminal function selection (*F104, F108, F110 to F115*), the enabled command and frequency will be given the priority.

Once enabled, this setting will be enabled till disable is set (0 setting), power is turned off or is reset, or factory default setting (*EEP*) is selected. Electric power quantity reset is always enabled even though communication command priority is not set.

Table 2 Data construction of communication command 2 (FA20)

Bit	Function	0	1	Remarks
0	(Reserved)	-	-	
1	Electric power quantity reset	OFF	Reset	Electric power quantity (FE76, FE77) reset
2	(Reserved)	-	-	
3	(Reserved)	-	-	
4	(Reserved)	-	-	
5	(Reserved)	-	-	
6	(Reserved)	-	-	
7	Maximum deceleration forced stop	Normal	Enabled	
8	Acceleration/deceleration pattern selection 1	00: Acceleration/deceleration 1 01: Acceleration/deceleration 2 10: Acceleration/deceleration 3 11: Do not use		Select Acceleration/ deceleration 1 - 3 by combination of two bits AD1: <i>ACC, DEC</i> AD2: <i>F500, F501</i> AD3: <i>F510, F511</i>
9	Acceleration/deceleration pattern selection 2			
10	(Reserved)	-	-	
11	(Reserved)	-	-	
12	OC stall level switch	OC stall 1	OC stall 2	OC stall 1 : <i>F501</i> OC stall 2 : <i>F185</i>
13	(Reserved)	-	-	
14	(Reserved)	-	-	
15	(Reserved)	-	-	

Note: Set 0 to reserved bit

■ **Communication command 3 (FA26)**

The RY Terminal Output Hold Command and OUT Terminal Output Hold Command are always enabled even though communication command priority is not set.

Table 3 Data construction of communication command 3 (FA26)

Bit	Function	0	1	Remarks
0	RY terminal output hold	OFF	Once it is turned on, a RY terminal holds that condition.	Always enabled even if communication command is not enabled
1	OUT terminal output hold	OFF	Once it is turned on, an OUT terminal holds that condition.	Always enabled even if communication command is not enabled
2-15	(Reserved)	-	-	

Note: Set 0 to reserved bit

■ Frequency setting from the computer (FA01)

Setting range: 0 to maximum frequency (FH)

This frequency command value is enabled only when the frequency command by communication is enabled. To make frequency commands from the computer valid, set the frequency setting mode selection parameter ($F\overline{N}\overline{O}\overline{d}$) to RS485 communication (communication No. 0004: 4 (RS485 communication input) or select the "Frequency priority" option (bit 14 of FA00 : 1 (enabled)). In this case, frequency commands by communication will be enabled independent of $F\overline{N}\overline{O}\overline{d}$ setting.

However, enabled commands and frequencies are given the priority if "48 (49): Forced switching from communication to local," is set by input terminal function selection ($F104, F108, F110$ to $F115$).

Once enabled, this frequency setting will be enabled till disable is set (0 setting), power is turned off or is reset, or factory default setting ($\underline{\text{t}}\overline{\text{y}}\overline{\text{P}}$) is selected.

Set a frequency by communication hexadecimal in Communication Number FA01. (1=0.01Hz (unit))

Example: Operation frequency 80Hz command RS485 communication (PFA011F40) CR
 $80\text{Hz}=80\div 0.01=8000=1\text{F}40\text{H}$

■ Motor speed command setting from the computer (FA13)

Setting range: 0 to 24000min⁻¹

The number of motor poles is selected by to $F\overline{B}\overline{5}\overline{5}$.

The motor speed command can be set from FA13.

The output frequency is converted from the motor speed command by the following calculation formula.

If the output frequency is more than FH , Inverter return the error to the computer and the motor speed command is ignored.

$$\text{Output frequency [0.01Hz]} = (\text{Output motor speed [min}^{-1}\text{]} \times \text{poles [}F\overline{B}\overline{5}\overline{5}\text{]}) \div 120$$

This frequency command is enabled only when the frequency command by communication is enabled by setting "RS485 communication ("4" for Communication Number 0004) by the speed command selection parameter ($F\overline{N}\overline{O}\overline{d}$) or setting frequency priority (Bit 14 of Communication Number FA00 to "1" (enable)) by the communication command. In this case, frequency command by communication will be enabled independent of $F\overline{N}\overline{O}\overline{d}$ setting. However, enabled commands and frequencies are given the priority if "48: Forced change from communication to local," "52: Forced operation," or "53: Fire speed" is set by input terminal function selection ($F104, F108, F110$ to $F118$).

Once enabled, this frequency setting will be enabled till disable is set (0 setting), power is turned off or is reset, or standard shipment setting ($\underline{\text{t}}\overline{\text{y}}\overline{\text{P}}$) is selected.

Set a speed by communication hexadecimal in Communication Number FA13. (1 = 1min⁻¹ (unit))

Example: $F\overline{B}\overline{5}\overline{5}=\overline{2}$: 4 poles, Speed command is 1800min⁻¹ (PFA130708) CR
 $60.00\text{ Hz} = (1800\text{ min}^{-1} \times 4\text{ poles}) \div 120$

■ **Output data on the terminal board (FA50)**

The output data on the terminal board can be directly controlled with the computer. To use this function, select functions from 92 to 95 in advance for the output terminal selection parameters *F 130*, *F 131*, *F 132*. If bit 0 through bit1 of the data (FA50) is set with the computer, the specified data (0 or 1) can be output to the selected output terminal.

Data composition of output data on the terminal board (FA50)

Bit	Output terminal function	0	1
0	Specified data output 1 (Output terminal no.: 92, 93)	OFF	ON
1	Specified data output 2 (Output terminal no.: 94, 95)	OFF	ON
2-15	(Reserved)	-	-

Note: Set 0 to reserved bit

Example of use: To control only the RY-RC terminal with the computer

To turn on the RY terminal, set the output terminal selection 1A parameter (*F 130*) to 92 (Designated data output 1) and set 0001H to FA50.

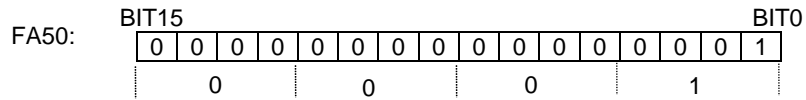

■ **FM analog output (FA51)**

The FM analog output terminal on each inverter can be directly controlled with the computer. To use this function, set the FM terminal meter selection parameter (*F 151*) to 18 (RS485 communication data). This makes it possible to send out the data specified as FM analog output (FA51) through the FM analog output terminal. Data can be adjusted in a range of 0 to 100.0 (resolution of 10 bits). For details, refer to “Meter setting and adjustment” of the inverter’s instruction manual.

■ **Information for reset or not (FA87)**

FA87 sets to ‘1’ by user-communication. If the inverter reset, FA87 set to ‘0’ by the inverter.

8.2. Monitoring from the computer

This section explains how to monitor the operating status of the inverter from the computer.

■ Monitoring of the output frequency from the computer (FD00, FE00)

Output frequency (current status): "Communication Number FD00" (unit: 0.01Hz)

Output frequency (status immediately before the occurrence of a trip): "Communication Number FE00" (unit: 0.01Hz)"

The current output frequency is read out in hexadecimal in units of 0.01Hz. For example, if the output frequency is 80Hz, 1F40H (hexadecimal number) is read out. Since the unit is 0.01Hz, 1F40H (hexadecimal number) = 8000 (decimal number) x 0.01 = 80 (Hz)

Example: Monitoring of the output frequency (operation frequency: 50Hz) . . . (1F40H=8000d, 8000x0.1=80Hz)

<u>Computer→Inverter</u>	<u>Inverter→Computer</u>
(RFD00)CR	(RFD001F40)CR

■ Monitoring of the output current with the computer (FD03, FE03)

Output current (current status): "Communication Number FD03" (unit: 0.01%)

Output current (status immediately before the occurrence of a trip): "Communication Number FE03" (unit: 0.01%)

The current output current is read out in hexadecimal in units of 0.01%. For example, if the output current of an inverter with a current rating of 4.8A is 2.4A (50%), 1388H (hexadecimal number) is read out. Since the unit is 0.01%, 1388H (hexadecimal number) = 5000 (decimal number) x 0.01 = 50 (%)

Example: Monitoring of the output current (output current: 90%) . . . (2328H=9000d, 9000x0.01=90%)

<u>Computer→Inverter</u>	<u>Inverter→Computer</u>
(FRD03)CR	(RFD032328)CR

The following items are also calculated in the same way.

- FD05 (output voltage)Unit: 0.01% (V)
- FD04 (DC voltage)Unit: 0.01% (V)

■ Input terminal block status (FD06, FE06)

Input terminal block status (current status): "Communication Number FD06"

Input terminal block status (status immediately before the occurrence of a trip): "Communication Number FE06"

Using terminal function selection parameters, functions can be assigned individually to the terminals on the input terminal block.

If a terminal function selection parameter is set to 0 (no function assigned), turning on or off the corresponding terminal does not affect the operation of the inverter, so that you can use the terminal as you choose.

When using a terminal as a monitoring terminal, check beforehand the function assigned to each terminal.

Data composition of input terminal block status (FD06, FE06)

Bit	Terminal name	Function (parameter title)	0	1
0	F	Input terminal function selection 1 (F 1 1 1)	OFF	ON
1	R	Input terminal function selection 2 (F 1 1 2)		
2	RES	Input terminal function selection 2 (F 1 1 3)		
3	S1	Input terminal function selection 4 (F 1 1 4)		
4	S2	Input terminal function selection 5 (F 1 1 5)		
5	S3 *1	Input terminal function selection 6 (F 1 1 6)		
6	VIB *2	Input terminal function selection 7 (F 1 1 7)		
7	VIA *2	Input terminal function selection 8 (F 1 1 8)		
8 to 15	(Undefined)	---	---	---

Note: The bit described "Undefined" is unstable. Don't use the bit for the judgment.

*2:S3 function when F 1 4 7 is logic input.

*2:VIA / VIB function when F 1 0 9 is logic input.

Example: Data set for FE06 when the F and RES terminals are ON = 0005H

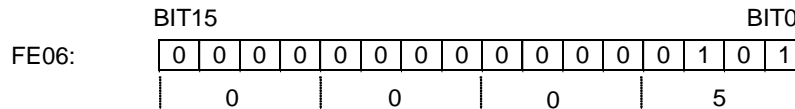

■ **Output terminal block status (FD07, FE07)**

Output terminal block status (current status): "Communication Number FD07"

Output terminal block status (status immediately before the occurrence of a trip): "Communication Number FE07"

Using terminal function selection parameters, functions can be assigned individually to the terminals on the output terminal block.

When using a terminal as a monitoring terminal, check beforehand the function assigned to each terminal.

Data composition of output terminal block status (FD07, FE07)

Bit	Terminal name	Function (parameter title)	0	1
0	RY-RC	Output terminal function selection 1 (F 130)	OFF	ON
1	OUT	Output terminal function selection 2 (F 131)		
2	FL	Output terminal function selection 3 (F 132)		
3 to 15	(Undefined)	-	-	-

Note: The bit described "Undefined" is unstable. Don't use the bit for the judgment.

Example: Data set for FE07 when both the RY and FL terminals are ON = 0005H

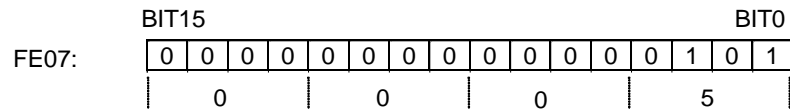

■ **Monitoring of the analog input with the computer (FE35, FE36, FE37)**

Terminal VIA monitor (current status): "Communication Number FE35" (unit: 0.01%)

Terminal VIB monitor (current status): "Communication Number FE36" (unit: 0.01%)

Terminal VIC monitor (current status): "Communication Number FE37" (unit: 0.01%)

These monitors can also be used as A/D converters irrespective of the inverter's control.

Terminal VIA and Terminal VIC monitor are capable of reading the data from external devices in a range of 0.00 to 100.00% (unsigned data: 0H to 2710H).

Terminal VIB monitor is capable of reading the data from external devices in a range of -100.00 to 100.00% (signed data: D8F0H to 2710H).

If analog input mode is selected with the frequency setting mode selection parameter, however, keep in mind that any data entered via an analog terminal is regarded as a frequency command.

■ Status information 1 (FD01, FE01)

Status information 1 (current status): "Communication Number FD01"

Status information 1 (status immediately before the occurrence of a trip): "Communication No. FE01"

Bit	Specifications	0	1	Remarks
0	Failure FL	No output	Output in progress	
1	Failure	Not tripped	Tripped	Trip statuses include <i>rtr</i> and trip retention status.
2	Alarm	No alarm	Alarm issued	
3	Under voltage(<i>NOFF</i>)	Normal	Under voltage	
4	Motor section (1 or 2) (THR 2 selection)	Motor 1 (THR 1)	Motor 2 (THR 2)	THR1 : <i>Pt</i> =setting value, <i>uL, uLu, ub, tHr</i> THR2 : <i>Pt=0, F170,</i> <i>F171, F172, F173</i>
5	PID control OFF	PID control permitted	PID control prohibited	
6	Acceleration/deceleration pattern selection (1 or 2)	Acceleration/ deceleration pattern 1 (AD 1)	Acceleration/ deceleration pattern 2 (AD 2)	AD1 : <i>ACC, DEC</i> AD2 : <i>F500, F501</i>
7	DC braking	OFF	Forced DC braking	
8	Jog run	OFF	Jog run	
9	Forward/reverse run	Forward run	Reverse run	
10	Run/stop	Stop	Run	
11	Coast stop (ST=OFF)	ST=ON	ST=OFF	
12	Emergency stop	Not emergency stop status	Emergency stop status	
13	Standby ST=ON	Start-up process	Standby	Standby: Initialization completed, not failure stop status, not alarm stop status (<i>NOFF</i> , LL forced stop), ST=ON, and RUN=ON
14	Standby	Start-up process	Standby	Standby: Initialization completed, not failure stop status, and not alarm stop status (<i>NOFF</i> , LL forced stop)
15	(Undefined)	-	-	

Note: The bit described "Undefined" is unstable. Don't use the bit for the judgment.

■ **Status information 2 (FD42, FE42)**

Status information 2 (current status): "Communication Number FD42"

Status information 2 (status immediately before the occurrence of a trip): "Communication No. FE42"

Bit	Function	0	1	Remarks
0	(Undefined)	-	-	
1	(Undefined)	-	-	
2	(Undefined)	-	-	
3	(Undefined)	-	-	
4	(Undefined)	-	-	
5	(Undefined)	-	-	
6	(Undefined)	-	-	
7	Maximum deceleration forced stop	Normal	Operation	
8	Acceleration/deceleration pattern selection1	00:Acceleration/deceleration 1 01:Acceleration/deceleration 2 10:Acceleration/deceleration 3		AD1 : <i>RCC, DEC</i> AD2 : <i>F500, F501</i> AD3 : <i>F510, F511</i>
9	Acceleration/deceleration pattern selection2			
10	(Undefined)	-	-	
11	(Undefined)	-	-	
12	OC stall level	OC stall 1	OC stall 2	OC stall 1 : <i>F601</i> OC stall 2 : <i>F185</i>
13	(Undefined)	-	-	
14	(Undefined)	-	-	
15	(Undefined)	-	-	

Note: The bit described "Undefined" is unstable. Don't use the bit for the judgment.

■ **Status information 3 (FD49, FE49)**

Status information 3 (current status): "Communication Number FD49"

Status information 3 (status immediately before the occurrence of a trip): "Communication No. FE49"

Bit	Function	0	1	Remarks
0	RY terminal output hold	OFF	ON	
1	OUT terminal output hold	OFF	ON	
2 to 9	(Undefined)	-	-	
10	Running (const)	OFF	ON	
11	Healthy signal	OFF	ON	This bit repeats On/off every second.
12	Acceleration/deceleration completion (RCH)	OFF	ON	Related parameters <i>F102</i>
13	Specified speed reach (RCHF)	OFF	ON	Related parameters <i>F101, F102</i>
14	Running (Acceleration)	OFF	ON	
15	Running (deceleration)	OFF	ON	

Note: The bit described "Undefined" is unstable. Don't use the bit for the judgment.

■ Cumulative operation time alarm monitor (FE79)

Cumulative operation time alarm monitor (current status): "Communication Number FE79"

Bit	Specifications	0	1	Remarks
0	Fan life alarm	Normal	Alarm issued	-
1	Circuit board life alarm	Normal	Alarm issued	-
2	Main-circuit capacitor life alarm	Normal	Alarm issued	-
3	Cumulative operation time alarm	Normal	Alarm issued	<i>F 5 2 1</i>
4	Number of starting alarm	Normal	Alarm issued	<i>F 5 4 8</i>
5-15	(Undefined)	-	-	-

Note: The bit described "Undefined" is unstable. Don't use the bit for the judgment.

■ Output motor speed monitor (FD90, FE90)

Output motor speed monitor (current status): "Communication Number FD90" (unit: 1min⁻¹)

Output motor speed monitor (status immediately before the occurrence of a trip): "Communication Number FE90" (unit: 1min⁻¹)

Ex.: Output motor speed monitor (during 60 Hz operation and 4 poles (*F 8 5 5 = 2*: 4 poles)
... (0708H = 1800d, 1800min⁻¹)

The number of motor poles is selected by *F 8 5 5*.

The output motor speed is converted from the output frequency by the following calculation formula.

$$\text{Output motor speed [min}^{-1}\text{]} = (120 \times \text{Output frequency [0.01Hz]}) \div \text{poles [F 8 5 5]}$$

$$1800 \text{ min}^{-1} = (120 \times 60.00\text{Hz}) \div 4 \text{ poles}$$

Computer → Inverter Inverter → Computer
(RFE90) CR (RFE900708) CR

■ Alarm information 1(FC91)

Alarm information monitor (current status): "Communication Number FC91"

Bit	Specifications	0	1	Remarks (Code displayed on the panel)
0	Over-current alarm	Normal	Alarming	<i>L</i> flickering
1	Inverter overload alarm	Normal	Alarming	<i>L</i> flickering
2	Motor overload alarm	Normal	Alarming	<i>L</i> flickering
3	Overheat alarm	Normal	Alarming	<i>H</i> flickering
4	Overvoltage alarm	Normal	Alarming	<i>P</i> flickering
5	Undervoltage alarm	Normal	Alarming	-
6	Main module overload alarm	Normal	Alarming	<i>L</i> flickering
7	Low current alarm	Normal	Alarming	-
8	Over-torque alarm	Normal	Alarming	-
9	Braking resistor overload alarm	Normal	Alarming	-
10	Cumulative operation time alarm	Normal	Alarming	<i>F 5 2 1</i>
11	Option communication alarm	Normal	Alarming	<i>L</i> flickering
12	Serial communication alarm	Normal	Alarming	<i>L</i> flickering
13	Main-circuit voltage error alarm	Normal	Alarming	<i>n o f f</i> flickering
14	Regenerative power ride-through control	-	Decelerating, stopping	Related: <i>F 3 0 2</i> setting
15	Stop at lower-limit frequency operation (sleep function)	-	Decelerating, stopping	Related: <i>F 2 5 5</i> setting

Note: The bit described "Undefined" is unstable. Don't use the bit for the judgment.

■ Alarm information 2(FC92)

Alarm information monitor (current status): "Communication Number FC92"

Bit	Specifications	0	1	Remarks (Code displayed on the panel)
0	(Undefined)	-	-	-
1	(Undefined)	-	-	-
2	Life time alarm	Normal	Alarming	Bit0 to 2 of FE79, <i>FE48</i>
3	Over torque alarm	Normal	Alarming	From <i>FE15</i> to <i>FE19</i>
4	Over load stall alarm	Normal	Alarming	-
5	(Undefined)	-	-	-
6	(Undefined)	-	-	-
7	Output frequency upper limit alarm	Normal	Alarming	<i>R-05</i> is displayed
8	PTC alarm	Normal	Alarming	-
9	Analog input disconnection alarm	Normal	Alarming	<i>AL05</i> is displayed
10	Cooling fan replacement alarm	Normal	Alarming	-
11	Number of start alarm	Normal	Alarming	<i>FE48</i>
12	S3 terminal alarm	Normal	Alarming	-
13	Shock monitoring alarm	Normal	Alarming	From <i>F590</i> to <i>F598</i>
14	(Undefined)	-	-	-
15	(Undefined)	-	-	-

Note: The bit described "Undefined" is unstable. Don't use the bit for the judgment.

■ Inverter operating command mode status (FD45)

Inverter operating command mode status (current status): "Communication Number FD45"

The monitor of the command mode that the present condition is enabled

Data	Enabled command
0	Terminal block
1	Panel keypad (including extension panel)
2	RS485 communication
3	CANopen communication
4	Communication option

Note: This data is not compatible on the inverter type.

■ Inverter operating frequency mode status (FD46)

Inverter operating frequency mode status (current status): "Communication Number FD46"

The monitor of the frequency command mode that the present condition is enabled

Data	Enabled frequency
0	Setting dial 1(save even if power is off)
1	Terminal VIA
2	Terminal VIB
3	Setting dial 2(press in center to save)
4	RS485 communication
5	UP/DOWN from external logic input
6	CANopen communication
7	Communication option
8	Terminal VIC
9	-
10	-
11	Pulse train input
12	-
13	-
14	Preset-speed frequency 0 (<i>Fr0</i>)
255	Preset-speed frequency 1 to 15

Note: This data is not compatible on the inverter type.

- Trip code monitor (current status:FC90: historic records:FE10 to FE13,FD10 to FD13)

Code	Data (hexa-decimal number)	Data (decimal number)	Description
<i>nErrr</i>	0	0	No error
<i>OC1</i>	1	1	Over-current during acceleration
<i>OC2</i>	2	2	Over-current during deceleration
<i>OC3</i>	3	3	Over-current during constant speed operation
<i>OC4</i>	4	4	Over-current in load at startup
<i>OCRA</i>	5	5	Arm overcurrent at start-up
<i>EPH1</i>	8	8	Input phase failure
<i>EPH0</i>	9	9	Output phase failure
<i>OP1</i>	A	10	Overvoltage during acceleration
<i>OP2</i>	B	11	Overvoltage during deceleration
<i>OP3</i>	C	12	Overvoltage during constant speed operation
<i>OL1</i>	D	13	Inverter overload
<i>OL2</i>	E	14	Motor overload
<i>OLr</i>	F	15	Dynamic braking resistor overload trip
<i>OH</i>	10	16	Overheat
<i>E</i>	11	17	Emergency stop
<i>EEP1</i>	12	18	EEPROM fault 1
<i>EEP2</i>	13	19	EEPROM fault 2
<i>EEP3</i>	14	20	EEPROM fault 3
<i>Errr2</i>	15	21	Main unit RAM fault
<i>Errr3</i>	16	22	Main unit ROM fault
<i>Errr4</i>	17	23	CPU fault 1
<i>Errr5</i>	18	24	Communication time-out error
<i>Errr7</i>	1A	26	Current detector fault
<i>Errr8</i>	1B	27	Optional unit fault 1
<i>Errr9</i>	1C	28	Remote keypad disconnection fault
<i>UC</i>	1D	29	Low current operation fault
<i>UP1</i>	1E	30	Undervoltage fault (main circuit)
<i>Ot</i>	20	32	Over-torque trip 1
<i>EF2</i>	22	34	Ground fault
<i>Etn</i>	28	40	Auto-tuning error
<i>EtyP</i>	29	41	Inverter type error
<i>E-13</i>	2D	45	Over speed fault
<i>OH2</i>	2E	46	Thermal fault stopcommand from external device
<i>SOUt</i>	2F	47	Step-out (for PM motor drive only)
<i>E-18</i>	32	50	Analog input break detection fault
<i>E-19</i>	33	51	CPU communications error
<i>E-20</i>	34	52	Over torque boost fault
<i>E-21</i>	35	53	CPU fault 2
<i>E-23</i>	37	55	Optional unit fault 2
<i>E-26</i>	3A	58	CPU fault 3
<i>OL3</i>	3E	62	Main mudule overload
<i>E-31</i>	3F	63	Heavy cycle of main power ON/OFF
<i>E-32</i>	40	64	PTC fault
<i>Ot2</i>	41	65	Over-torque trip 2
<i>E-37</i>	45	69	Servo lock fault
<i>E-39</i>	47	71	Auto-tuning error (PM motor)
<i>OtC3</i>	48	72	Over-torque / Overcurrent fault
<i>UtC3</i>	49	73	Small-torque / Small -current fault
<i>Etn1</i>	54	84	Auto-tuning error 1
<i>Etn2</i>	55	85	Auto-tuning error 2
<i>Etn3</i>	56	86	Auto-tuning error 3
<i>E-27</i>	57	87	Internal circuit fault

8.3.Utilizing panel (LEDs and keys) by communication

The VF-S15 can display data that is not related to the inverters through an external controller or other means. Input by key operations can also be executed. The use of inverter resources reduces the cost for the entire system.

8.3.1. LED setting by communication

Desired LED information can be displayed by communication.

<How to Set>

Set the standard monitor display selection parameter to “communication LED setting (F710=18).”

When in the standard monitor mode status, LED information is displayed according to the setting of Communication Number FA65. (Set to Communication Number FA65 = 1 and initial data “dRtR” in shipment setting)

In case of an alarm while setting communication LEDs, the alarm display will alternately display specified LED data and alarm message.

For example, if an over-current alarm (alarm display “E”) occurs while “E0.0” is displayed by this function, “E” and “E0.0” will be displayed alternately.

Communication Number.	Parameter Name	Range	Shipment setting
FA65	Select display by communication	0: Numeric data (FA66, FA67, FA68) 1: ASCII data 1 (FA70, FA71, FA72, FA73, FA74) 2: ASCII data 2 (FA75, FA76, FA77, FA78, FA79)	1
FA66	Numeric display data (Enabled if FA65=0)	0-9999	0
FA67	Decimal point position (Enabled if FA65=0)	0: No decimal point (xxxx) 1: First digit below decimal point (xxx.x) 2: Second digit below decimal point (xx.xx)	0
FA68	LED data 0 for unit (Enabled if FA65=0)	0: Hz off, % off, 1: Hz on, % off 2: Hz off, % on, 3: Hz on, % on	0
FA70	ASCII display data 1, first digit from left (Enabled if FA65=1)	0 – 127 [0 – 7FH] (See ASCII LED display code chart)	100 [64H] (‘d’)
FA71	ASCII display data 1, second digit from left (Enabled if FA65=1)	0 – 256 [0 – FFH] (See ASCII LED display code chart)	65 [41H] (‘R’)
FA72	ASCII display data 1, third digit from left (Enabled if FA65=1)	0 – 256 [0 – FFH] (See ASCII LED display code chart)	116 [74H] (‘t’)
FA73	ASCII display data 1, fourth digit from left (Enabled if FA65=1)	0 – 127 [0 – 7FH] (See ASCII LED display code chart)	65 [41H] (‘R’)
FA74	LED data 1 for unit (Enabled if FA65=1)	0: Hz off, % off, 1: Hz on, % off 2: Hz off, % on, 3: Hz on, % on	0
FA75	ASCII display data 2, first digit from left (Enabled if FA65=2)	0 – 127 [0 – 7FH] (See ASCII LED display code chart)	48 [30H] (‘0’)
FA76	ASCII display data 2, second digit from left (Enabled if FA65=2)	0 – 256 [0 – FFH] (See ASCII LED display code chart)	48 [30H] (‘0’)
FA77	ASCII display data 2, third digit from left (Enabled if FA65=2)	0 – 256 [0 – FFH] (See ASCII LED display code chart))	48 [30H] (‘0’)
FA78	ASCII display data 2, fourth digit from left (Enabled if FA65=2)	0 – 127 [0 – 7FH] (See ASCII LED display code chart)	48 [30H] (‘0’)
FA79	LED data 2 for unit (Enabled if FA65=2)	0: Hz off, % off, 1: Hz on, % off 2: Hz off, % on, 3: Hz on, % on	0

■ Block Communication Function for LED Display

To display LED data for ASCII display that is synchronized to each digit, set data for each digit and validate this set data by display selection by communication (Communication Number FA65). Synchronization can also be achieved by batch writing LED data parameters after changing the following block communication mode parameters and by sending data by block communication. Writing in the block communication function will be writing in the RAM only due to the EEPROM life for write operations. The LED data will reset to the initial value "dRtR" when the power is turned off, in failure resetting or when standard shipment settings are set.

■ Parameter Setting

"Block communication mode (Communication Number FA80)"

Setting range: 0, 1 (Initial value 0)

0: Block communication parameters (FB70 - FB79) is used

1: LED display ASCII data is used (When writing, ASCII display data 1 [Communication Number FA70 - FA74], when reading, LED data displayed before change)

*To validate LED data set by using LED display block communication, set standard monitor display selection to "communication LED select (F710 = 1B) and display selection by communication to "ASCII data 1 (Communication Number FA65).

■ Format

The format is the same as that used in the usual block communication mode. (For the detail information, see "4.1.3. Transmission format of Block Communication".) The block communication parameters (FB70 - FB79) will become invalid. Write data will become ASCII display data 1 (Communication Number: FA70 - FA74) fixed. LED display data that is actually being output will be read during reading. The specification range for write operations is 0 to 5.

■ Example

Communication LED selection (F710 = 1B) for standard monitor display selection.

ASCII data 1 (Communication Number: FA65 = 1) for display selection by communication.

LED display ASCII data (Communication Number: FA80 = 1) for the block communication mode.

Current LED display status is display of initial value "dRtR"

PC → Inverter: 2F580505003000310032003300035A ... "0123" display command

Inverter → PC: 2F59050000640041007400410000E7 ... "dRtR" displayed before change

■ ASCII LED display data code (00H-1FH are blank.)

Hex Code	Display	Char.	Hex Code	Display	Char.	Hex Code	Display	Char.	Hex Code	Display	Char.
00H	BLANK		20H	BLANK	SP	40H	BLANK	@	60H	BLANK	`
01H	BLANK		21H	BLANK	!	41H		A	61H		a
02H	BLANK		22H	BLANK		42H		B	62H		b
03H	BLANK		23H	BLANK	#	43H		C	63H		c
04H	BLANK		24H	BLANK	\$	44H		D	64H		d
05H	BLANK		25H	BLANK	%	45H		E	65H		e
06H	BLANK		26H	BLANK	&	46H		F	66H		f
07H	BLANK		27H	BLANK		47H		G	67H		g
08H	BLANK		28H		(48H		H	68H		h
09H	BLANK		29H)	49H		I	69H		i
0AH	BLANK		2AH	BLANK	*	4AH		J	6AH		j
0BH	BLANK		2BH	BLANK	+	4BH		K	6BH		k
0CH	BLANK		2CH	DGP	,	4CH		L	6CH		l
0DH	BLANK		2DH		-	4DH		M	6DH		m
0EH	BLANK		2EH	DGP	.	4EH		N	6EH		n
0FH	BLANK		2FH		/	4FH		O	6FH		o
10H			30H		0	50H		P	70H		p
11H			31HT		1	51H		Q	71H		q
12H			32H		2	52H		R	72H		r
13H			33H		3	53H		S	73H		s
14H			34H		4	54H		T	74H		t
15H			35H		5	55H		U	75H		u
16H			36H		6	56H		V	76H		v
17H			37H		7	57H	BLANK	W	77H	BLANK	w
18H			38H		8	58H	BLANK	X	78H	BLANK	x
19H			39H		9	59H		Y	79H		y
1AH			3AH	BLANK	:	5AH	BLANK	Z	7AH	BLANK	z
1BH			3BH	BLANK	;	5BH		[7BH		{
1CH			3CH		<	5CH		\	7CH	BLANK	
1DH			3DH		=	5DH]	7DH		}
1EH	BLANK		3EH		>	5EH		^	7EH	BLANK	→
1FH	BLANK		3FH	BLANK	?	5FH		_	7FH	BLANK	

*Dots to show decimal points and other uses can be added by setting (80H) Bit 7 (highest bit).

Example: "0." to display "60.0" can be added by "30H + 80H = B0H."

8.3.2.Key utilization by communication

The VF-S15 can use the panel keys on the inverters through external communication.

■ Key Monitoring Procedure

Set panel key selection (Communication Number: FA10) to "1" to set the external key mode. However, if communication duration is less than 1sec to avoid an inverter operation shutdown in communication disruption, communication must always be maintained, such as monitoring key data and LED data to automatically reset inverter operations to inverter key operation (FA10 = 0). Set to the external communication key mode (FA10 = 1) to disable the key function of the inverters so that inverter operation will not be affected by pressing of the keys on the inverters. By monitoring key information, which is input by the keys on the inverters in this condition, through inverter key data (Communication Number; FC01), the keys on the inverters can be operated through a controller and other devices.

* When the key mode is the external key mode, key operation as an inverter function is disabled and the inverters cannot be stopped by pressing the STOP key to stop inverter operation. Enable emergency stop through an external terminal or other device when an inverter stop is desired.

Panel Key Selection (Communication Number: FA10)

The panel key selection parameter (Communication Number; FA10) discriminates which keys are to be used, panel keys on the inverters or keys sent by external communication, as panel keys used in panel processing of the inverters.

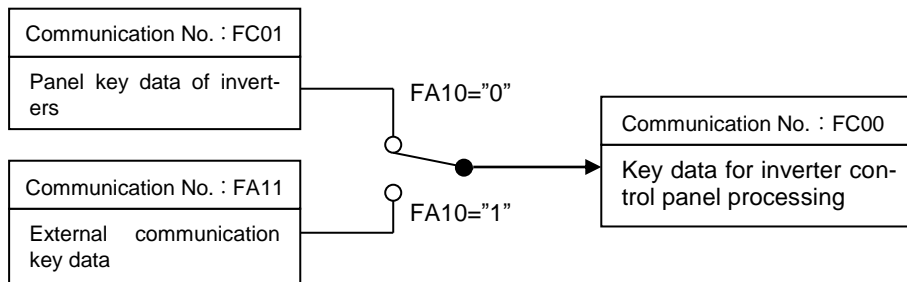

Keys on inverters enabled (Communication Number; FA10 = 0):

Key data: Data of keys on inverters (Communication Number: FC01)

Bit15	Bit14-Bit9	Bit8	Bit7	Bit6	Bit5	Bit4	Bit3	Bit2	Bit1	Bit0
-	-	-	-	EASY	ENT	MODE	DOWN	UP	STOP	RUN

External keys enabled (Communication Number; FA10 = 1):

Key data: External key data (Communication Number: FA11)

Bit15	Bit14-Bit9	Bit8	Bit7	Bit6	Bit5	Bit4	Bit3	Bit2	Bit1	Bit0
-	-	-	LOC/REM	EASY	ENT	MODE	DOWN	UP	STOP	RUN

Key monitoring (Communication Number: FC00): * Bit15 is 1 when the key is normal.

Bit15	Bit14-Bit9	Bit8	Bit7	Bit6	Bit5	Bit4	Bit3	Bit2	Bit1	Bit0
1	-	-	LOC/REM	EASY	ENT	MODE	DOWN	UP	STOP	RUN

9.Parameter data

Explanation of parameters for VF-S15 series is described here. For communication purposes, see the parameter list on inverter's instruction manual regarding the communication number, adjustment range and so forth.

- Referring to the parameter list

<Example of excerpts from the inverter's instruction manual>

Title	Communication No.	Function	Adjustment range	Minimum setting unit (Panel/Communication)	Default setting	Reference
<i>RUH</i>	-	History function	-	-	-	4.3 5.1
<i>RUR</i>		Apprication easy setting	-	-	0	
<i>RUF</i>	-	Guidance function	-	-	0	4.3 5.2
<i>RUL</i>	0094	Overload characteristic selection	0: - 1: Constant torque characteristic (150%-60s) 2: Variable torque characteristic (120%-60s)	1/1	0	3.5 5.3 6.14
<i>RUI</i>	0000	Automatic acceleration/deceration	0: Disabled(manual setting) 1: Automatic 2: Automatic(only at acceleration)	1/1	0	5.4

<i>RLL</i>	0009	Acceleration time 1	0.0~3600 sec.	0.1/0.1	10.0	5.4
------------	------	---------------------	---------------	---------	------	-----

- The summary of parameter list relating to the communication is as follows.

- "Title" means the display on the inverter panel.
- "Communication number" is affixed to each parameter that is necessary for designating the parameter for communication.
- "Adjustment range" means a data range adjustable for a parameter, and the data cannot be written outside the range. The data have been expressed in the decimal notation. For writing the data through the communication function, take the minimum setting unit into consideration, and use hexadecimal system.
- "Minimum setup unit" is the unit of a single data (when the minimum setting unit is "-", 1 is equal to 1). For example, the "minimum setting unit" of acceleration time (*RLL*) is 0.1, and 1 is equal to 0.1s. For setting a data to 10 seconds, transmit 64h [10÷0.1=100d=64h] by communication. If 0999 is equal to 2, the acceleration/deceleration time parameters *RLL*, *dEL*, *F500*, *F501*, *F510*, *F511* can be set in units of 0.1 sec. If 0999 is equal to 1, these parameters can be set in units of 0.01 sec.

■ Acceleration/deceleration setting time unit (0999)

Communication No.	Function name	Unit	Adjustment range
0999	Acceleration/deceleration time unit	-	1: 0.01 sec. (0.01-360.00) 2: 0.1 sec. (0.1-3600.0)

Note: Don't write the communication number of 0999. The acceleration/deceleration time unit is set by *F519*.

- When data is a negative number, it treats as an one's complement expression (ex. FFFFH is equal to '-1').
- Communication numbers "xxxAH" to "xxxFH" and "xxAxH" to "xxFxH" don't exist in VF-S15. Therefore, these communication numbers are automatically skipped when read by Block Read command: Direct (03H) in Modbus RTU protocol. For example: When the data of two words is read from *RLL* (0009h), 000Ah doesn't exist because of this specification. Consequently, in this case *RLL* (0009h) and *dEL* (0010h) are read.

■ Command parameters

For those parameters that contain data only in the RAM and not in the EEPROM, their data return to initial values when the power is turned off, in failure resetting, or when standard shipment settings are set. Note that parameters without data storage in the EEPROMs will be written in the RAM only even if the command W (writing in EEPROMs and RAM) is executed.

■ Commands

Note: Data is expressed in decimal notation.

Communication Number.(HEX)	Function	Adjustment Range	Min. Setting Unit	Initial Value	Write During Operator	EEP ROM
FA00	Communication command 1 (RS485) ^{*1}	0 to 65535	-	0	yes	None
FA01	Frequency command value (RS485) ^{*1}	0 to Max. frequency (FH)	0.01Hz	0	yes	None
FA03	Operation panel operation frequency	Low-limit frequency (LL) to High-limit frequency (UL)	0.01Hz	0	yes	Available
FA08	Local/Remote selection	0: Remote 1: Local	-	0	yes	Available
FA10	Panel key selection ^{*3}	0: Main unit 1: Communication	-	0	yes	None
FA11	External communication key data ^{*3}	0 to 65535	-	0	yes	None
FA13	Motor speed command (FA13)	0 to 24000min ⁻¹	1min ⁻¹	0	yes	None
FA20	Communication command 2 (RS485) ^{*1}	0 to 65535	-	0	yes	None
FA26	Communication command 3	0 to 65535	-	0	yes	None
FA50	Output data on the terminal board ^{*2}	0 to 255	1	0	yes	None
FA51	FM analog output ^{*2}	0 to 100.0 (resolution of 10 bits)	0.1%	0	yes	None
FA65	Select display by communication ^{*3}	0 to 2	-	1	yes	Available
FA66	Numerical display data ^{*3}	0-9999	1	0	yes	Available
FA67	Decimal point position ^{*3}	0 to 2	-	0	yes	Available
FA68	LED data for unit 0 ^{*3}	0 to 3	-	0	yes	Available
FA70	ASCII display data 1 First digit from left ^{*3}	0 to 127	-	100 ('d')	yes	Available
FA71	ASCII display data 1 Second digit from left ^{*3}	0 to 255	-	65 ('R')	yes	Available
FA72	ASCII display data 1 Third digit from left ^{*3}	0 to 255	-	116 ('t')	yes	Available
FA73	ASCII display data 1 Fourth digit from left ^{*3}	0 to 127	-	65 ('R')	yes	Available
FA74	LED data for unit1 ^{*3}	0 to 3	-	0	yes	Available
FA75	ASCII display data 2 First digit from left ^{*3}	0 to 127	-	48 ('U')	yes	Available
FA76	ASCII display data 2 Second digit from left ^{*3}	0 to 255	-	48 ('U')	yes	Available
FA77	ASCII display data 2 Third digit from left ^{*3}	0 to 255	-	48 ('U')	yes	Available
FA78	ASCII display data 2 Fourth digit from left ^{*3}	0 to 127	-	48 ('U')	yes	Available
FA79	LED data for unit 2 ^{*3}	0 to 3	-	0	yes	Available
FA80	Block communication mode ^{*3}	0 to 1	-	0	yes	Available
FA87	Reset information	0 to 255	-	0	yes	None

*1:Enable the communication command or communication frequency setting before setting these parameters are set. Otherwise, the parameters will not function. See "8.1. Command by communication" for the method to enable them.

*2:See "8.1. Communication commands (command from the computer)" for the detail information.

*3:See "8.3. Utilizing panel (LEDs and keys) by communication" for the detail information.

■ Monitor parameters

*These Parameters are read-only (monitor-only) parameters.

(1 / 2)

Communication No.		Function	Unit	Remarks
Current value	Trip data held			
0999	-	Acceleration/deceleration time unit	-	Chapter 9
FB05	-	Inverter capacity code	-	Appendix 3
FB07	-	Inverter series type	-	The value of VFS15 is 224.
FC00	-	Monitor of key data (Effective data)	-	Refer to Section 8.3
FC01	-	Monitor of inverter keypad data	-	
FC90	-	Trip code	-	Refer to Section 8.2
FC91	-	Alarm information 1	-	
FC92	-	Alarm information 2	-	
FD00	FE00	Output frequency	0.01Hz	
FD01	FE01	Status information 1	-	
FD02	FE02	Frequency command value	0.01Hz	
FD03	FE03	Output current	0.01%	
FD04	FE04	Input voltage (DC detection)	0.01%	
FD05	FE05	Output voltage	0.01%	
FD06	FE06	Input terminal information	-	Refer to Section 8.2
FD07	FE07	Output terminal information	-	
FD10	-	Past trip 5	-	
FD11	-	Past trip 6	-	
FD12	-	Past trip 7	-	
FD13	-	Past trip 8 (earliest)	-	
FE08	-	CPU version 1 (application)	-	Refer to Section 8.2
FE10	-	Past trip 1 (latest)	-	
FE11	-	Past trip 2	-	
FE12	-	Past trip 3	-	
FE13	-	Past trip 4	-	
FE14	-	Cumulative operation time	1=1hour	
FD15	FE15	Compensated frequency	0.01Hz	
FD16	FE16	Estimated speed	0.01Hz	
FD18	FE18	Torque	0.01%	
FD20	FE20	Torque current	0.01%	
FD22	FE22	PID feedback value	0.01Hz	
FD23	FE23	Motor overload factor (OL2 data)	0.01%	
FD24	FE24	Inverter overload factor (OL1 data)	0.01%	
FD25	FE25	PBR (Braking resistor) cumulative load factor	1%	
FD26	FE26	Motor load factor	1%	
FD27	FE27	Inverter load factor	1%	
FD28	FE28	Regenerative braking resistance load factor	1%	
FD29	FE29	Input power	0.01kW	
FD30	FE30	Output power	0.01kW	
FD32	-	Number of starting	1=1000times	
FD33	-	Forward number of starting		
FD34	-	Reverse number of starting		
FE35	-	Terminal VIA monitor	0.01%	Refer to Section 8.2
FE36	-	Terminal VIB monitor		
FE37	-	Terminal VIC monitor		
FE40	-	FM output value	0.01%	
FD40	-	Pulse train output value	pps	
FD41	-	Cumulative fan operation time	1=10hour	
FD42	FE42	Status information 2	-	Refer to Section 8.2
FD49	FE49	Status information 3	-	

Communication No.		Function	Unit	Remarks
Current value	Trip data held			
FE56	-	Pulse train input value	pps	
FE70	-	Rated current	0.1A	
FE71	-	Rated voltage	0.1V	
FE73	-	CPU version 2 (motor)	-	
FE76	-	Integral input power	*4	
FE77	-	Integral output power	It depends on <i>F 749</i> . 1=0.1kWh <i>F 749</i> =0 1= 1kWh <i>F 749</i> =1 1=10kWh <i>F 749</i> =2 1=100kWh <i>F 749</i> =3 1=1000kWh <i>F 749</i> =4 *5	
FE79	-	Part replacement alarm information	-	Refer to Section 8.2
FE80	-	Cumulative power ON time	1=10hour	
FD90	FE90	Output motor speed monitor	min ⁻¹	Refer to Section 8.2

*4: The inverter's instruction manual is written by the scale of LED monitor. This manual is written by the scale of communication. For that reason, the statement is different with these manuals.

*5: The value of integral power can be calculated as "FE76(or FE77) * the rate from *F 749*".

Appendix 1 Table of data codes

• JIS (ASCII) codes

Higher order Lower order	0	1	2	3	4	5	6	7
0	NUL	TC ₇ (DLE)	(SP)	0	@	P	,	p
1	TC ₁ (SOH)	DC ₁	!	1	A	Q	a	q
2	TC ₂ (STX)	DC ₂	"	2	B	R	b	r
3	TC ₃ (ETX)	DC ₃	#	3	C	S	c	s
4	TC ₄ (EOT)	DC ₄	\$	4	D	T	d	t
5	TC ₅ (ENQ)	TC ₈ (NAK)	%	5	E	U	e	u
6	TC ₆ (ACK)	TC ₉ (SYN)	&	6	F	V	f	v
7	BEL	TC ₁₀ (ETB)	'	7	G	W	g	w
8	FE ₀ (BS)	CAN	(8	H	X	h	x
9	FE ₁ (HT)	EM)	0	I	Y	i	y
A	FE ₂ (LF)	SUB	*	:	J	Z	j	z
B	FE ₃ (VT)	ESC	+	;	K	[k	{
C	FE ₄ (FF)	IS ₄ (FS)	.	<	L	¥	l	
D	FE ₅ (CR)	IS ₃ (GS)	-	=	M]	m	}
E	SO	IS ₂ (RS)	.	>	N	^	n	~
F	SI	IS ₁ (US)	/	?	O	_	o	DEL

CR: Carriage return

Ex.: Code 41 = Character A

Appendix 2 Response time

The communication response time can be calculated from data communication time and inverter processing time. When wishing to know the communication response time, calculate using the following as a reference.

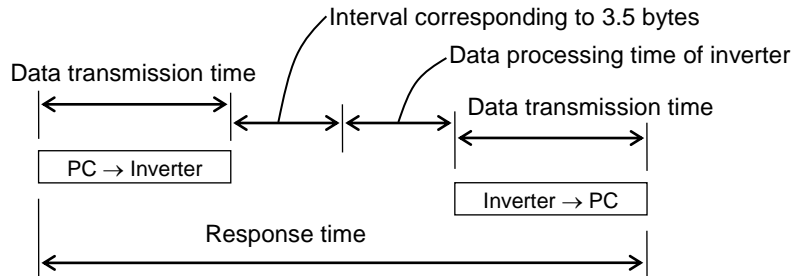

- Data transmission time

$$\text{Data transmission time} = \frac{1}{\text{baud rate}} \times \text{number of bytes transmitted} \times \text{number of bits}$$

* Number of bits = start bit + data frame length + parity bit + stop bit

* Minimum number of bits = 1 + 8 + 0 + 1 = 10 bits

* Maximum number of bits = 1 + 8 + 1 + 2 = 12 bits

<An example of the calculation of the transmission time: 19200 bps, 8 bytes, 11 bits>

$$\text{Data transmission time} = \frac{1}{19200} \times 8 \times 11 = 4.6\text{ms}$$

- Data processing time of inverter

Data processing time: maximum 10ms

Note: The maximum time becomes 50ms to set EEPROM. See "9. Parameter data" about EEPROM.

Appendix 3 Inverter capacity code (FB05)

■ 3-phase 240V class

Type and Form	Voltage / Capacity	Inverter capacity code (FB05)	
		Hexadecimal	Decimal
VFS15-2004PM-W	Three-phase 200/240V 0.4kW	2	2
VFS15-2007PM-W	Three-phase 200/240V 0.75kW	4	4
VFS15-2015PM-W	Three-phase 200/240V 1.5kW	6	6
VFS15-2022PM-W	Three-phase 200/240V 2.2kW	7	7
VFS15-2037PM-W	Three-phase 200/240V 3.7/4.0kW	9	9
VFS15-2055PM-W	Three-phase 200/240V 5.5kW	A	10
VFS15-2075PM-W	Three-phase 200/240V 7.5kW	B	11
VFS15-2110PM-W	Three-phase 200/240V 11kW	6C	108
VFS15-2150PM-W	Three-phase 200/240V 15kW	6D	109

■ 1-phase 240V class

Type and Form	Voltage / Capacity	Inverter capacity code (FB05)	
		Hexadecimal	Decimal
VFS15S-2002PL-W	Single-phase 200/240V 0.2kW	19	25
VFS15S-2004PL-W	Single-phase 200/240V 0.4kW	1A	26
VFS15S-2007PL-W	Single-phase 200/240V 0.75kW	1C	28
VFS15S-2015PL-W	Single-phase 200/240V 1.5kW	1E	30
VFS15S-2022PL-W	Single-phase 200/240V 2.2kW	1F	31

■ 3-phase 500V class

Type and Form	Voltage / Capacity	Inverter capacity code (FB05)	
		Hexadecimal	Decimal
VFS15-4004PL-W	Three-phase 380/500V 0.4kW	22	34
VFS15-4007PL-W	Three-phase 380/500V 0.75kW	24	36
VFS15-4015PL-W	Three-phase 380/500V 1.5kW	26	38
VFS15-4022PL-W	Three-phase 380/500V 2.2kW	27	39
VFS15-4037PL-W	Three-phase 380/500V 3.7/4.0kW	29	41
VFS15-4055PL-W	Three-phase 380/500V 5.5kW	2A	42
VFS15-4075PL-W	Three-phase 380/500V 7.5kW	2B	43
VFS15-4110PL-W	Three-phase 380/500V 11kW	2C	44
VFS15-4150PL-W	Three-phase 380/500V 15kW	2D	45

■ 3-phase 500V class (For model changing)

Type and Form	Voltage / Capacity	Inverter capacity code (FB05)	
		Hexadecimal	Decimal
VFS15-4004PL1	Three-phase 380/500V 0.4kW	EA	234
VFS15-4007PL1	Three-phase 380/500V 0.75kW	EC	236
VFS15-4015PL1	Three-phase 380/500V 1.5kW	EE	238
VFS15-4022PL1	Three-phase 380/500V 2.2kW	EF	239
VFS15-4037PL1	Three-phase 380/500V 3.7kW	F1	241

■ 3-phase 600V class

Type and Form	Voltage / Capacity	Inverter capacity code (FB05)	
		Hexadecimal	Decimal
VFS15-6015P	Three-phase 525/600V 1.5kW	46	70
VFS15-6022P	Three-phase 525/600V 2.2kW	47	71
VFS15-6037P	Three-phase 525/600V 3.7kW	49	73
VFS15-6055P	Three-phase 525/600V 5.5kW	4A	74
VFS15-6075P	Three-phase 525/600V 7.5kW	4B	75
VFS15-6110P	Three-phase 525/600V 11kW	4C	76
VFS15-6150P	Three-phase 525/600V 15kW	4D	77

Appendix 4 Troubleshooting

If a problem arises, diagnose it in accordance with the following table before making a service call. If the problem cannot be solved by any remedy described in the table or if no remedy to the problem is specified in the table, contact your Toshiba distributor.

Problem	Remedies	Reference
Communication will not take place.	<ul style="list-style-type: none"> - Are both the computer and the inverter turned on? - Are all cables connected correctly and securely? The state of transmission and reception can be checked in the state of communication of the status monitor function of inverter. For details, please see inverter's instruction manual. - Are the same baud rate, parity and bit length set for every unit on the network? - Is the line of network equipped with a terminator/bias resistance? 	<p>Inverter's instruction manual Section 7.1</p> <p>Appendix 5</p>
An error code is returned.	<ul style="list-style-type: none"> - Is the data transmission format correct? - Does the data written fall within the specified range? - Some parameters cannot be written during inverter operation. Changing should be attempted when the inverter is in halt. - <i>F 700</i> (Parameter protection selection) is <i>2</i>: Writing prohibited (1+RS485 communication), <i>4</i>: Reading prohibited (3+RS485 communication) - If <i>F 738</i> (Password setting) was set to data, <i>F 738</i> can not set to data. 	<p>Section 4.1 Section 5.1 Chapter 9</p> <p>Inverter's instruction manual</p>
The trip <i>E r S</i> and alarm <i>t</i> occur.	<ul style="list-style-type: none"> - Check the cable connection and the timer setting. 	Section 7.3
Frequency instructions from the computer have no effect.	<ul style="list-style-type: none"> - Is the frequency setting mode selection parameter set to "computer"? 	Section 8.1
Commands, including the run and stop commands, from the computer have no effect.	<ul style="list-style-type: none"> - Is the command mode selection parameter set to "computer"? 	Inverter's instruction manual
A change to a parameter does not take effect.	Some communication-related parameters do not take effect until the inverter is reset. To make them take effect, turn the inverter off temporarily, and then turn it back on.	Chapter 7
The setting of a parameter was changed, but it returns to its original setting when the inverter is turned off.	When using the Toshiba inverter protocol, use the W command to write data into the EEPROM. If you use the P command that writes data into the RAMs only, the data will be cleared when the inverters are reset.	Section 4.2
The setting of a parameter was changed, but the function doesn't work.	<ul style="list-style-type: none"> - Some parameters become effective after the drive is reset. - The Modbus RTU protocol has usage restrictions. 	Chapter 7
The run command is released when the drive is the main power off (<i>NOFF</i>) or the command mode (<i>ENCd</i>) is changed.	Is the parameter of <i>F 719</i> (Selection of operation command clear) set to 2 or 3?	Inverter's instruction manual Section 7.7

Appendix 5 Connecting for RS485 communication

■ Connector diagram for two-wire RS485 communication

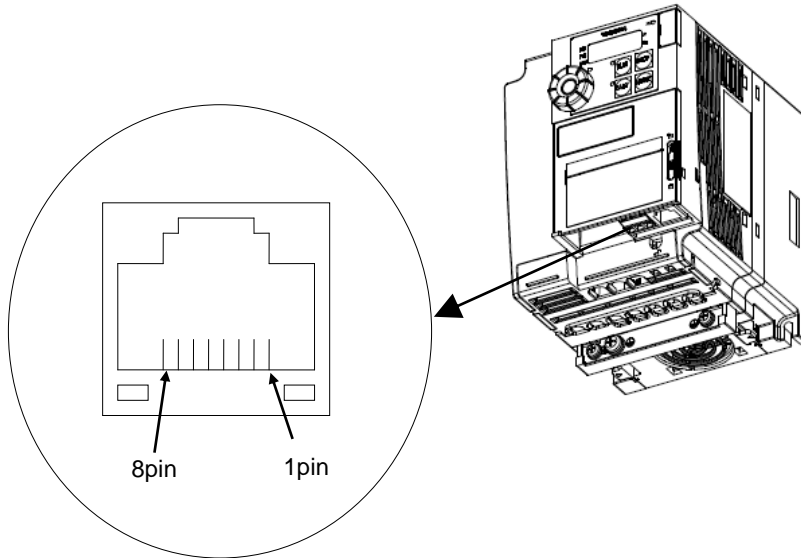

Signal name	Pin number	Description
RXD+/TXD+	4	Same phase reception data (positive line)
RXD-/TXD-	5	Anti-phase reception data (negative line)
SG	8 (3)	Ground line of signal data
---	6	--- (Do not connect the cable.)
---	1,2	--- (Do not connect the cable.)
P24	7	24V (Do not connect the cable.)

■ Pin assignment for two-wire RS485 communication example

* Never use pin-7 (P24).

